

AIRSTAGE

AIR CONDITIONER

Wall mounted type

FUJITSU

REFRIGERANT **R32**
INVERTER

SERVICE MANUAL

INDOOR



ASEH07KGTG
ASEH09KGTG
ASEH12KGTG
ASEH14KGTG

OUTDOOR



AOEH07KGCG
AOEH09KGCG
AOEH12KGCG
AOEH14KGCG

FUJITSU GENERAL LIMITED

SR_AS133ES_03
2025.04.08

Notices:

- Product specifications and design are subject to change without notice for future improvement.
- For further details, please check with our authorized dealer.

Trademarks

“AIRSTAGE Mobile” is a trademark of FUJITSU GENERAL LIMITED.

Android and Google Play are trademarks of Google LLC.

App Store is a service mark of Apple Inc., registered in the U.S. and other countries.

IOS is a trademark or registered trademark of Cisco in the U.S. and other countries and is used under license.

CONTENTS

1. GENERAL INFORMATION

2. TECHNICAL DATA AND PARTS LIST

3. TROUBLESHOOTING

4. CONTROL AND FUNCTIONS

5. FIELD WORKING

1. GENERAL INFORMATION

CONTENTS

1. GENERAL INFORMATION

1. Specifications	01-1
1-1. Indoor unit	01-1
1-2. Outdoor unit.....	01-3
2. Dimensions	01-4
2-1. Indoor unit	01-4
2-2. Outdoor unit.....	01-7

1. Specifications

1-1. Indoor unit

Type				Wall mounted					
				Inverter, Heat pump					
Model name				ASEH07KGTG	ASEH09KGTG	ASEH12KGTG	ASEH14KGTG		
Power supply intake				Outdoor unit					
System power supply				Voltage	230				
				Frequency	50				
				Available voltage range	198—264 V				
Indoor unit power supply (from outdoor unit)				230					
Capacity	Cooling	Rated	kW	2.0	2.5	3.4	4.2		
			Btu/h	6,800	8,500	11,600	14,300		
		Min.—Max.	kW	0.9—3.3	0.9—3.6	0.9—4.1	0.9—4.5		
	Heating		Btu/h	3,100—11,200	3,100—12,300	3,100—14,000	3,100—15,400		
		Rated	kW	2.5	2.8	4.0	5.4		
		Min.—Max.	kW	0.9—5.2	0.9—5.4	0.9—6.1	0.9—6.4		
Input power	Cooling	Rated	kW	0.40	0.55	0.87	1.22		
		Min.—Max.		0.25—0.95	0.25—1.14	0.25—1.29	0.25—1.45		
	Heating	Rated	0.50	0.60	0.91	1.45			
		Min.—Max.	0.25—1.59	0.25—1.84	0.25—1.83	0.25—2.11			
	Fan	HIGH	W	19	23	27	33		
		MED		15	17	18	20		
		LOW		12		13			
		QUIET		8					
	Current	Cooling	Rated	A	2.4	3.0	4.2	5.7	
		Heating			2.9	3.2	4.5	6.7	
Energy efficiency class	Cooling		A+++						
	Heating (Average)		A+++						
Pdesign	Cooling		kW	2.0	2.5	3.4	4.2		
	Heating (Average)			2.3	2.4	2.5	4.0		
SEER	Cooling		kWh/kWh	9.8	9.4	8.8	8.0		
SCOP	Heating (Average)			5.2			4.6		
Annual energy consumption	QCE		kWh/a	71	93	135	184		
	QHE (Average)			618	646	673	1,217		
EER	Cooling		kW/kW	5.00	4.55	3.91	3.44		
COP	Heating			5.00	4.67	4.40	3.72		
Sensible capacity	Cooling		kW	2.00	2.38	2.75	3.33		
Power factor	Cooling		%	72	80	90	93		
	Heating			75	82	88	94		
Moisture removal			L/h (pints/h)	1.1 (1.9)	1.3 (2.3)	1.6 (2.8)	1.7 (3.0)		
Maximum operating current*1	Cooling		A	6.5					
	Heating			9.0					
Fan	Airflow rate	Cooling	m ³ /h	HIGH	570	640	680	750	
				MED	500	530	550	590	
				LOW	420		430	450	
				QUIET	270		260	290	
		Heating	HIGH	610	630	750	780		
			MED	530		630	700		
			LOW	450		510			
			QUIET	290		320			
		Type × Qty		Crossflow fan × 1					
		Motor output		W		30		49	
Sound pressure level ²	Cooling	dB (A)	HIGH	36	38	40	43		
			MED	32	34	35	36		
			LOW	29		30			
			QUIET	19		20			
	Heating	HIGH	38	39	42	44			
		MED	34		38				
		LOW	31		33				
		QUIET	20		21				
Sound power level	Cooling	dB (A)	49	52	56	57			
	Heating		51	52	58	59			
Heat exchanger	Dimensions (H × W × D)		mm	Main 1: 210 × 670 × 26.6 Main 2: 112 × 670 × 20.0		Main 1: 210 × 670 × 26.6 Main 2: 112 × 670 × 20.0 Sub 1: 84 × 670 × 13.3			
	Fin pitch			Main 1: 1.2 Main 2: 1.1	Main 1: 1.2 Main 2: 1.1 Sub 1: 1.4				
	Rows × Stages		Main 1: 2 × 10 Main 2: 2 × 7	Main 1: 2 × 10 Main 2: 2 × 7 Sub 1: 1 × 4					
	Pipe type		Copper tube						
	Fin type		Aluminum						
Enclosure	Material		Polystyrene						
	Color		White + Pearl white (painted) Approximate color of Munsell N9.25/						
Dimensions (H × W × D)	Net		mm	270 × 834 × 215					
	Gross			277 × 914 × 332					
Weight	Net		kg	10.0					
	Gross			12.5	13.0				
Connection pipe	Size	Liquid	mm (in)	Ø6.35 (Ø1/4)					
		Gas		Ø9.52 (Ø3/8)					
Method		Flare							
Drain hose	Material		Polypropylene + High-density polyethylene						
	Tip diameter		Ø13.8 (I.D.), Ø15 to Ø16.8 (O.D.)						

Type			Wall mounted			
			Inverter, Heat pump			
Model name			ASEH07KGTG	ASEH09KGTG	ASEH12KGTG	ASEH14KGTG
Operation range	Cooling	°C	18 to 32			
		%RH	80 or less			
	Heating	°C	16 to 30			
Remote controller			Wireless (Option: Wired, Mobile app* ³ [AIRSTAGE Mobile])			
<p>NOTES:</p> <ul style="list-style-type: none"> • Specifications are based on the following conditions: <ul style="list-style-type: none"> – Cooling: Indoor temperature of 27°CDB/19°CWB, and outdoor temperature of 35°CDB/24°CWB. – Heating: Indoor temperature of 20°CDB/—°CWB, and outdoor temperature of 7°CDB/6°CWB. – Pipe length: 5.0 m, Height difference: 0 m. (Between outdoor unit and indoor unit.) • Protective function might work when using it outside the operation range. • *1: Maximum operating current is the total current of the indoor unit and the outdoor unit. • *2: Sound pressure level: <ul style="list-style-type: none"> – Measured values in manufacturer's anechoic chamber. – Because of the surrounding sound environment, the sound levels measured in actual installation conditions might be higher than the specified values here. • *3: Available on Google Play™ store or on App Store®. • This data is based on EN 14511 standard. 						

1-2. Outdoor unit

Type			Inverter, Heat pump						
Model name			AOEH07KGCG	AOEH09KGCG	AOEH12KGCG	AOEH14KGCG			
Power supply			230 V~ 50 Hz						
Power supply intake			Outdoor unit						
Available voltage range			198—264 V						
Starting current			A	2.9	3.2	4.5	6.7		
Fan	Airflow rate	Cooling	m ³ /h	1,390	1,480	1,800			
		Heating		1,350	1,420	1,690			
	Type × Qty	Propeller fan × 1							
	Motor output	W							
Sound pressure level*	Cooling	Heating	dB (A)	42	44	50			
				43	45	50			
Sound power level	Cooling	Heating		56	58	65			
				56	58	66			
Heat exchanger type	Dimensions (H × W × D)		mm	Main 1: 504 × 888 × 18.19		Main 1: 504 × 881 × 18.19			
				Main 2: 504 × 510 × 18.19		Main 2: 504 × 801 × 18.19			
	Fin pitch		Main 1: 1.3						
			Main 2: 1.3						
	Rows × Stages		Main 1: 1 × 24						
			Main 2: 1 × 24						
Pipe type		Copper tube							
Fin type		Type (Material)		Aluminum		PC fin			
		Surface treatment							
Compressor			Type				DC rotary		
			Motor output		W		900		
Refrigerant			Type (Global warming potential)				R32 (675)		
			Charge		g		750		850
Refrigerant oil			Type				POE (RB68A)		
			Amount		cm ³		340		
Enclosure			Material				Steel sheet		
			Color				Beige		
							Approximate color of Munsell 10YR 7.5/1.0		
Dimensions (H × W × D)		Net		mm		542 × 799 × 290			
		Gross				602 × 940 × 375			
Weight		Net		kg		30		31	32
		Gross				34		35	36
Connection pipe	Size	Liquid		mm (in)		Ø6.35 (Ø1/4)			
		Gas				Ø9.52 (Ø3/8)			
		Method				Flare			
	Pre-charge length		m		15				
	Max. length				20				
Max. height difference				15					
Operation range		Cooling		°C		-10 to 50			
		Heating				-15 to 24			
Drain hose			Material				Polypropylene		
			Tip diameter		mm		Ø13.0 (I.D.), Ø16.0 to Ø16.8 (O.D.)		

NOTES:

- Specifications are based on the following conditions:
 - Cooling: Indoor temperature of 27°CDB/19°CWB, and outdoor temperature of 35°CDB/24°CWB.
 - Heating: Indoor temperature of 20°CDB/—°CWB, and outdoor temperature of 7°CDB/6°CWB.
 - Pipe length: 5.0 m, Height difference: 0 m. (Between outdoor unit and indoor unit.)
- Protective function might work when using it outside the operation range.
- *: Sound pressure level
 - Measured values in manufacturer's semi-anechoic chamber.
 - Because of the surrounding sound environment, the sound levels measured in actual installation conditions might be higher than the specified values here.
- This data is based on EN 14511 standard.

2. Dimensions

2-1. Indoor unit

■ Models: ASEH07KGTG, ASEH09KGTG, ASEH12KGTG, and ASEH14KGTG

Unit: mm

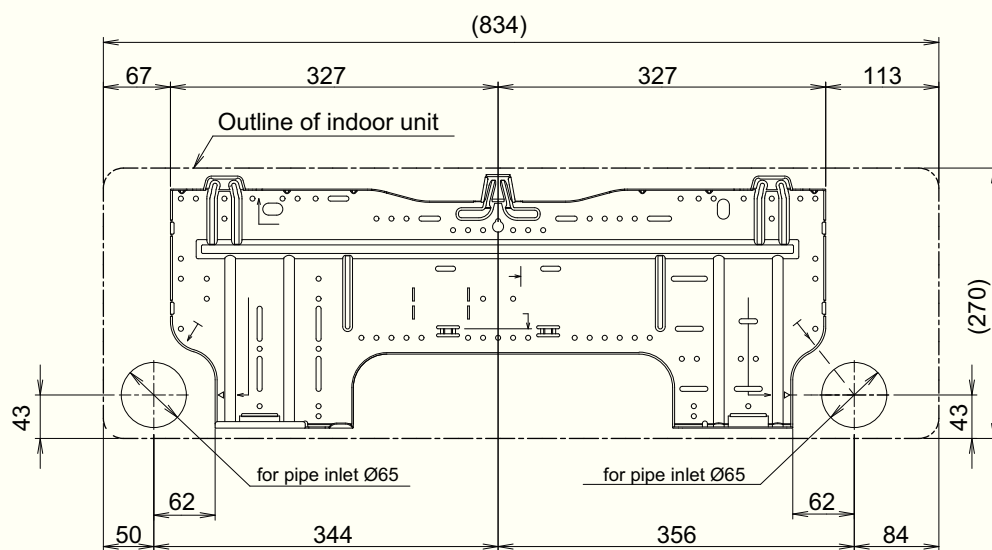
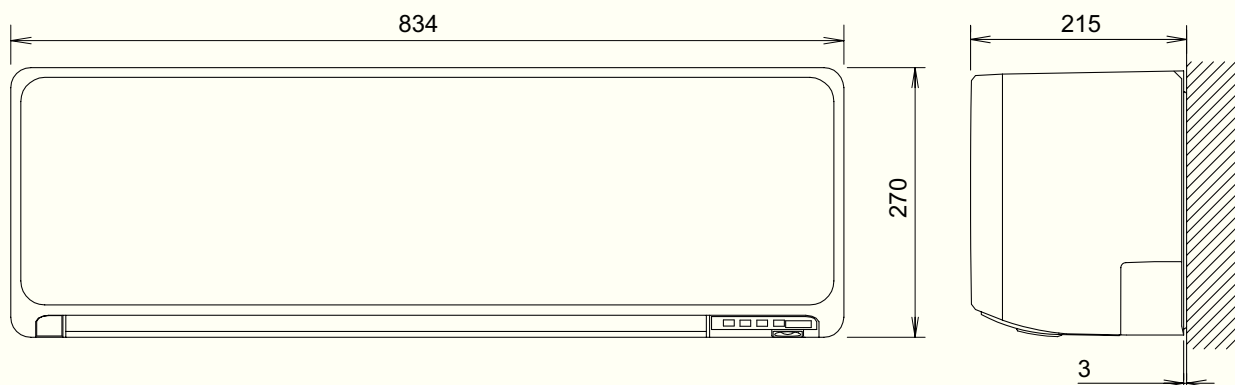

● Installation space requirement

Provide sufficient installation space for product safety.

Unit: mm

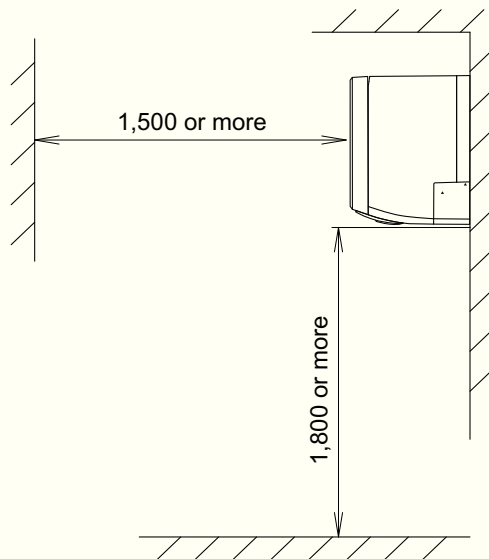
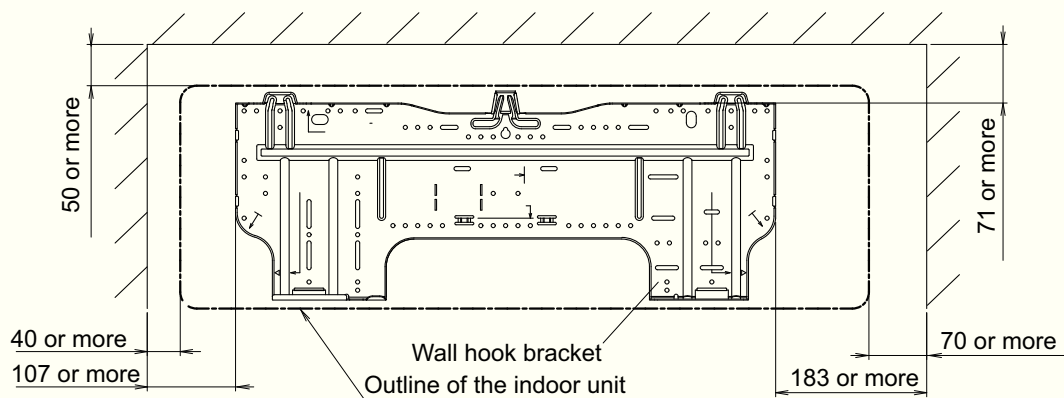

■ Pipe exit length from the rear

Design the system considering the length of the pipes or hose exiting from the rear of the indoor unit.

NOTE: Detailed shapes of the indoor unit and the tip of each pipe or hose may vary depending on the model.

Unit: mm

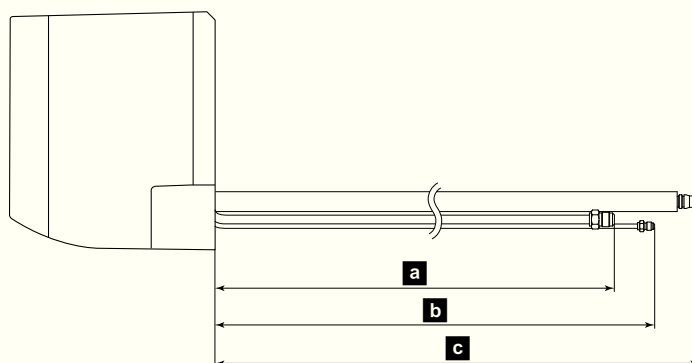

Model name	Approximate length		
	a Gas pipe	b Liquid pipe	c Drain hose
ASEH07-14KGTG	380	430	480

2-2. Outdoor unit

■ Models: AOEH07KGCG, AOEH09KGCG, AOEH12KGCG, and AOEH14KGCG

Unit: mm

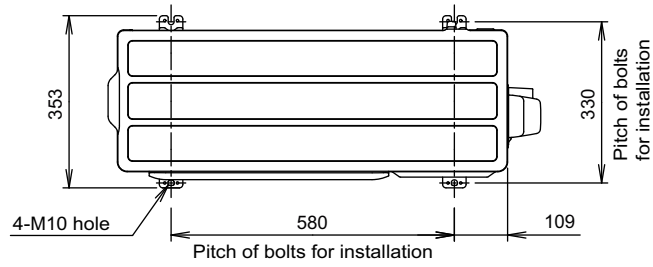

Top view

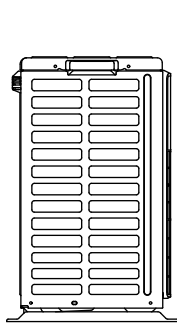

Side view

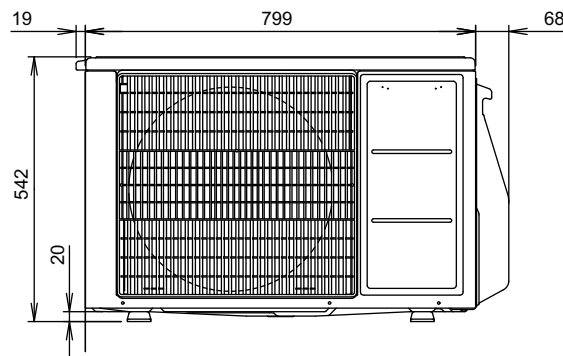

Front view

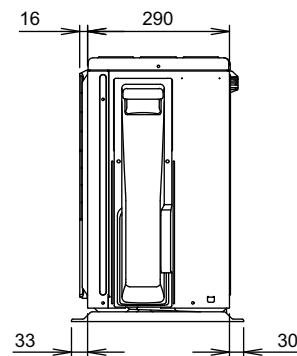

Side view

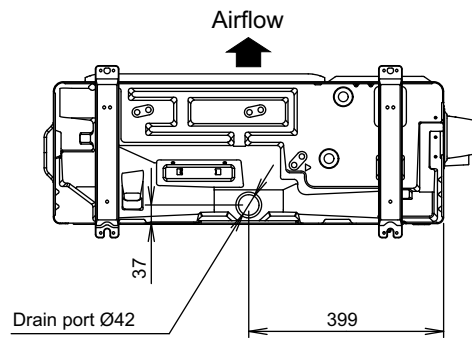

Bottom view

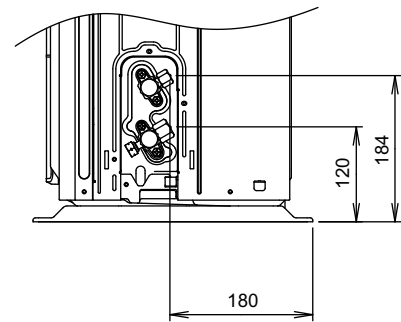

Side view (Valve part)

2. TECHNICAL DATA AND PARTS LIST

CONTENTS

2. TECHNICAL DATA AND PARTS LIST

1. Precautions	02-1
2. Indoor unit parts list	02-2
2-1. Models: ASEH07KGTG, ASEH09KGTG, ASEH12KGTG, and ASEH14KGTG.....	02-2
3. Outdoor unit parts list	02-6
3-1. Models: AOEH07KGCG, AOEH09KGCG, AOEH12KGCG, and AOEH14KGCG	02-6
4. Accessories	02-10
4-1. Indoor unit	02-10
4-2. Outdoor unit.....	02-10
5. Optional parts	02-11
5-1. Indoor unit	02-11
6. Refrigerant system diagrams	02-13
6-1. Models: AOEH07KGCG, AOEH09KGCG, AOEH12KGCG, and AOEH14KGCG	02-13
7. Wiring diagrams	02-14
7-1. Indoor unit	02-14
7-2. Outdoor unit.....	02-15
8. PC board diagrams	02-16
8-1. Models: ASEH07KGTG, ASEH09KGTG, ASEH12KGTG, and ASEH14KGTG.....	02-16
8-2. Models: AOEH07KGCG, AOEH09KGCG, AOEH12KGCG, and AOEH14KGCG	02-17

1. Precautions

When you start servicing, pay attention to the following points. For detailed precautions, refer to the installation manual of the products.

⚠ CAUTION

- Service personnel
 - Any person who is involved with working on or breaking into a refrigerant circuit should hold a current valid certificate from an industry-accredited assessment authority, which authorizes their competence to handle refrigerants safely in accordance with an industry recognized assessment specification.
 - Servicing shall only be performed as recommended by the equipment manufacturer. Maintenance and repair requiring the assistance of other skilled personnel shall be carried out under the supervision of the person competent in the use of flammable refrigerants.
 - Servicing shall be performed only as recommended by the manufacturer.
 - Work
 - Prior to beginning work on systems containing flammable refrigerants, safety checks are necessary to ensure that the risk of ignition is minimized. When repairing the refrigerant system, refer to the precautions written in the installation manual of the products before you start servicing.
 - Work shall be undertaken under a controlled procedure so as to minimize the risk of a flammable gas or vapor being present while the work is being performed.
 - All maintenance staff and others working in the local area shall be instructed on the nature of work being carried out.
 - Work in confined spaces shall be avoided.
 - The area around the workspace shall be sectioned off.
 - Ensure that the conditions within the area have been made safe by control of flammable material.
 - Electric shock may occur. After turning off the power, always wait 5 minutes before touching electrical components.
 - Do not touch the fins of the heat exchanger. Touching the heat exchanger fins could result in damage to the fins or personal injury such as skin rupture.
 - Do not place any other electrical products or household belongings under the product.
 - Condensation dripping from the product might get them wet, and may cause damage or malfunction to the property.
 - Checking for presence of refrigerant
 - The area shall be checked with an appropriate refrigerant leak detector prior to and during work, to ensure the technician is aware of potentially flammable atmospheres.
 - Ensure that the leak detector being used is suitable for use with flammable refrigerants, i.e. non-sparking, adequately sealed or intrinsically safe.
-
- Service parts information and design are subject to change without notice for product improvement.
 - For the latest information of the service parts, refer to our Service Portal.
<https://fujitsu-general.force.com/portal/>
 - Precise figure of the service parts listed in this manual may differ from the actual service parts.

2. Indoor unit parts list

2-1. Models: ASEH07KGTG, ASEH09KGTG, ASEH12KGTG, and ASEH14KGTG

■ Exterior parts

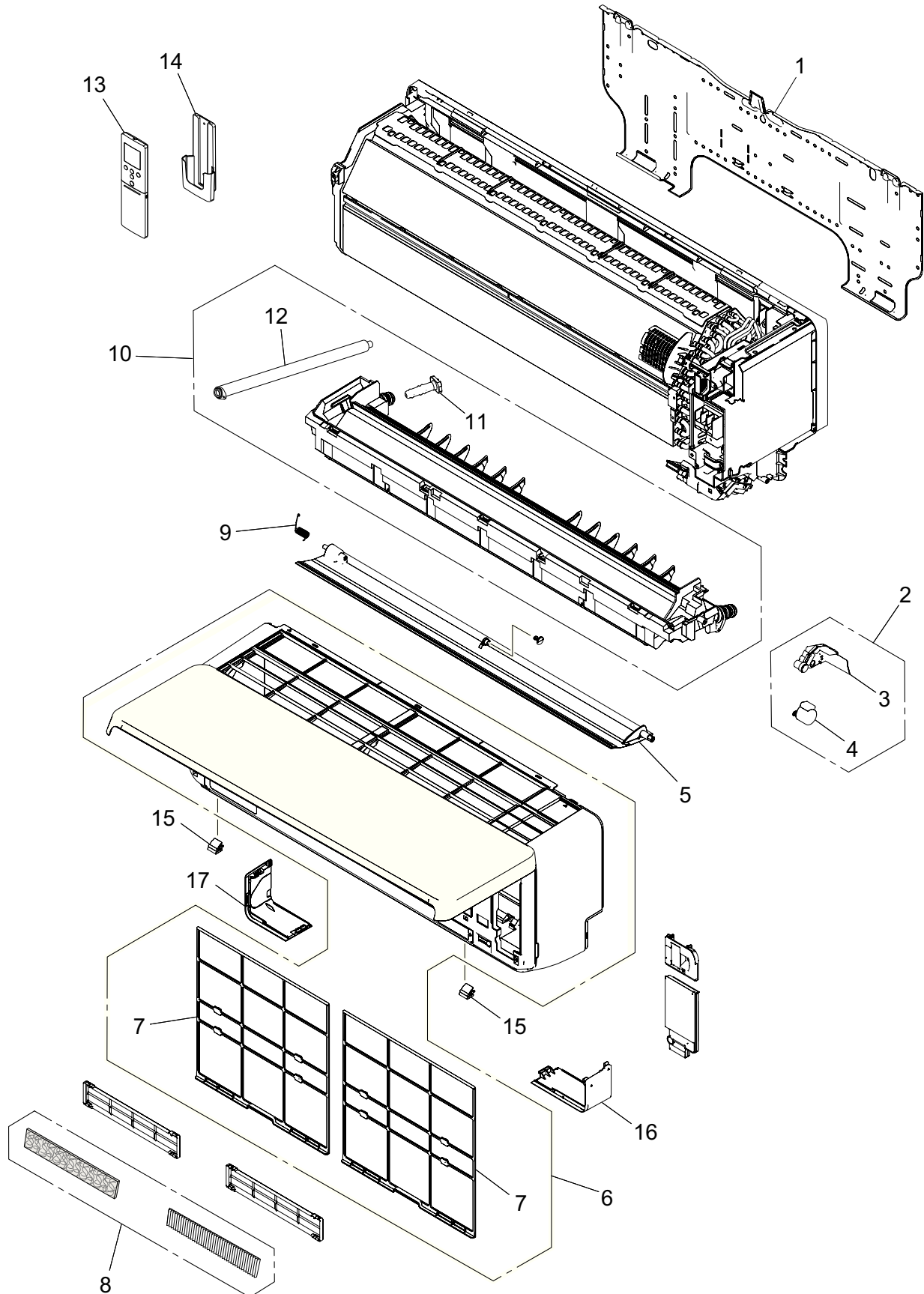

Item no.	Part no.	Part name
1	9388142005	Bracket panel
2	9387714036	Stepping motor holder assy
3	9387456004	Stepping motor holder
4	9901011047	Stepping motor
5	9387479003	Horizontal louver assy
6	9387596991	Front panel total assy
7	9387473032	Air filter
8	9317250009	Air clean filter assy
9	9387471007	Louver spring
10	9387590241	Drain pan total assy
11	9316177017	Drain cap
12	9316904002	Drain hose assy
13	9352446290	Remote controller
14	9318912005	Remote controller holder
15	9387476002	Screw cover
16	9387478051	Under cover R
17	9387477054	Under cover L

■ Base, evaporator, and control unit

TECHNICAL DATA
AND PARTS LIST

TECHNICAL DATA
AND PARTS LIST

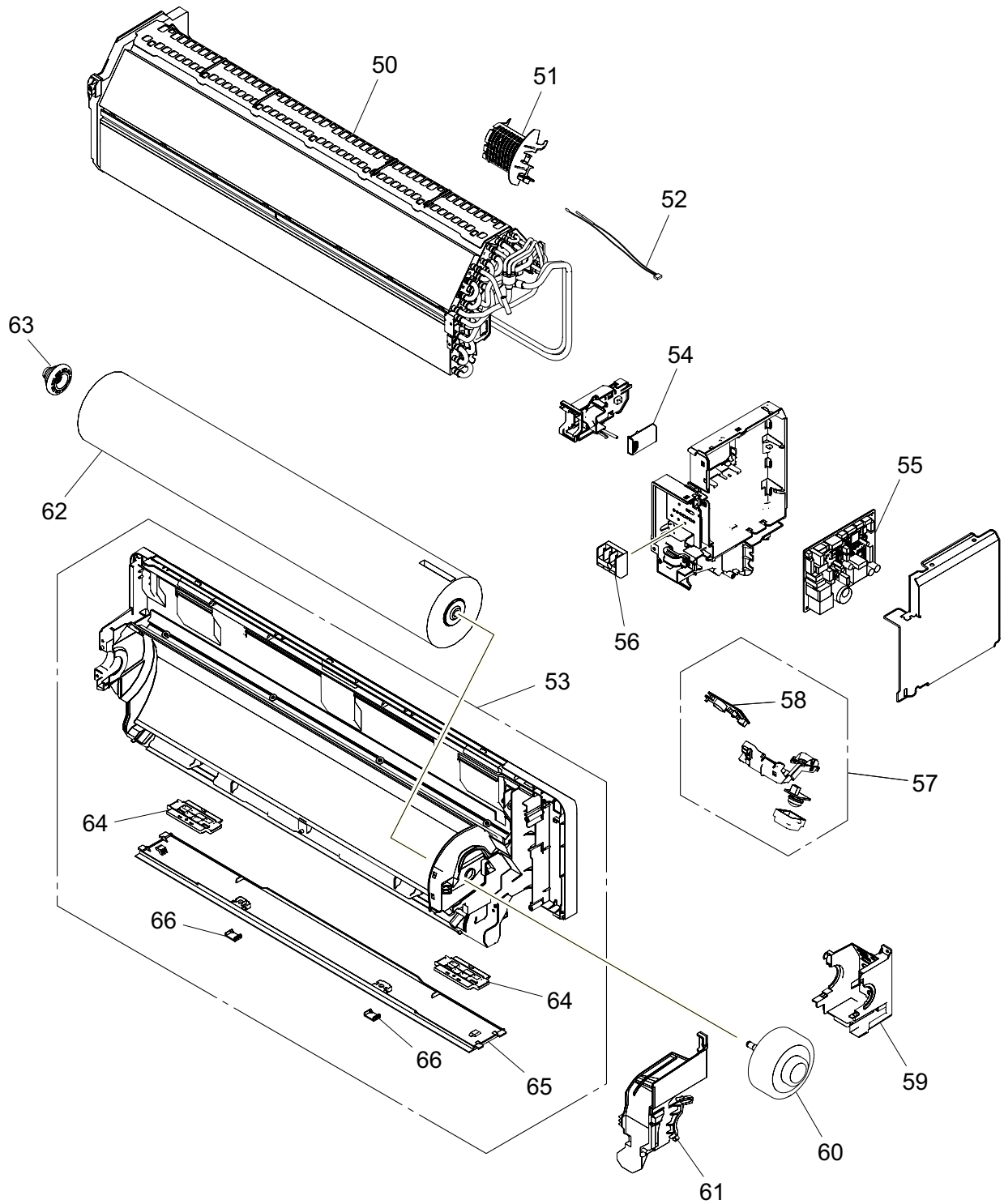

Item no.	Part no.	Part name
50	9387593877	Evaporator total assy (07 and 09 models)
	9387593839	Evaporator total assy (12 and 14 models)
51	9387467000	Room thermistor holder
52	9901160035	Thermistor assy
53	9387587128	Base assy
54	9384563040	WLAN Adapter
55	9712546455	Main PCB (07 model)
	9712546462	Main PCB (09 model)
	9712546479	Main PCB (12 model)
	9712546486	Main PCB (14 model)
56	9901013010	Terminal block 3P
57	9711146038	Indicator assy
58	9711147011	Indicator PCB
59	9384500014	Motor case sub assy
60	9604229015	DC fan motor (07 and 09 models)
	9604224034	DC fan motor (12 and 14 models)
61	9387713022	Motor cover assy
62	9387055047	Crossflow fan assy
63	9333628004	Bearing D assy
64	9388139005	Pipe bracket A
65	9388138008	Under cover C
66	9388182001	Screw cover
—	9901010071	Wire with connector (CN75 on Main PCB—Wireless LAN adapter)
—	9701439126	Wire with terminal (E1 on Main PCB—Earth terminal)

3. Outdoor unit parts list

3-1. Models: AOEH07KGCG, AOEH09KGCG, AOEH12KGCG, and AOEH14KGCG

■ Exterior parts and Chassis

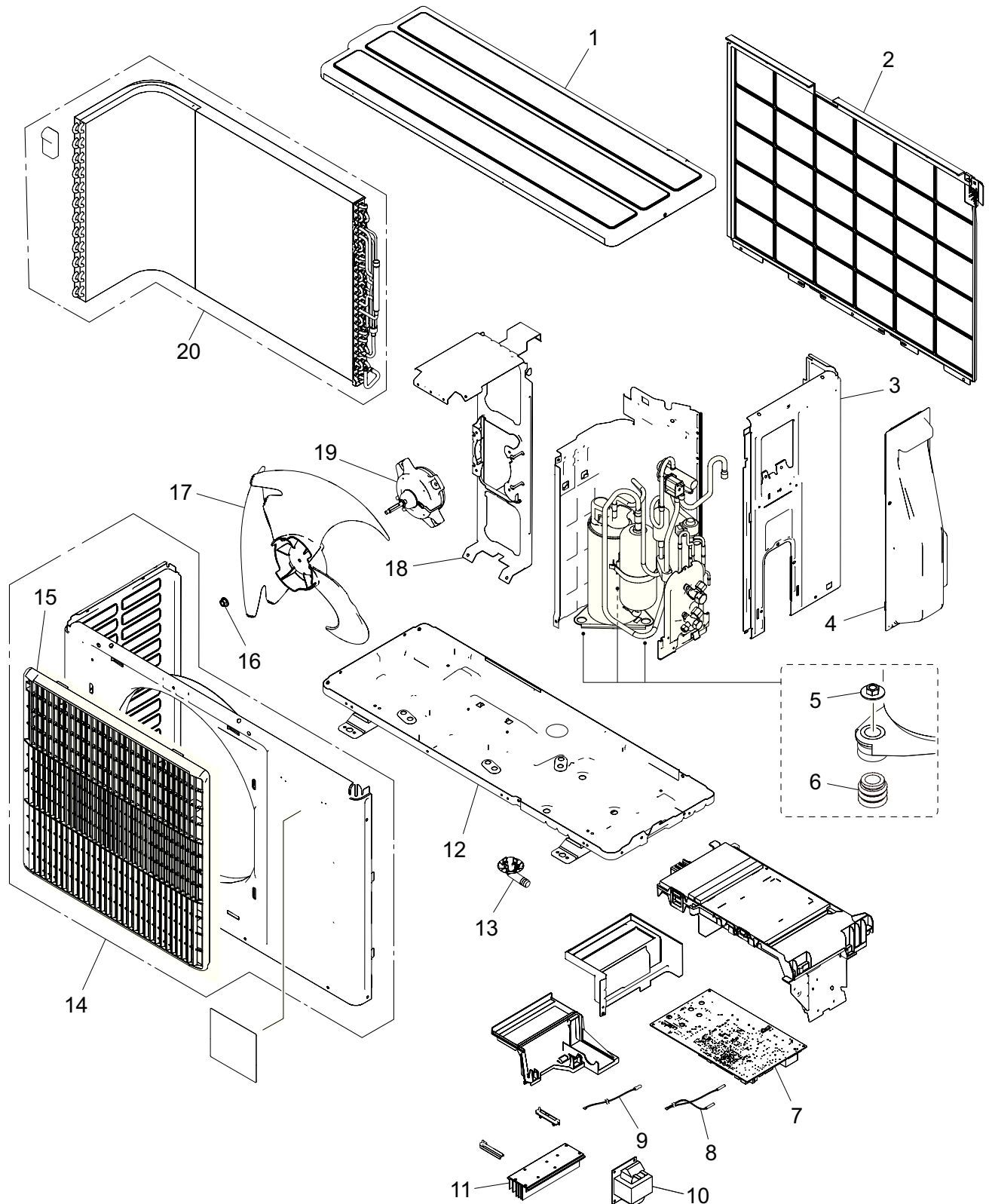

Item no.	Part no.	Part name
1	9322556028	Top panel assy
2	9322811011	Protective net assy
3	9322552020	Cabinet right assy
4	9322570000	Switch cover assy
5	N/A	Special nut (M8 with washer)
6	N/A	Rubber cushion
7	9709689479	Main PCB (07 model)
	9709689486	Main PCB (09 model)
	9709689493	Main PCB (12 model)
	9709689509	Main PCB (14 model)
8	9900727062	Thermistor assy (07 and 09 models)
	9900849016	Thermistor assy (12 and 14 models)
9	9900565060	Thermistor (Outdoor temp.) (07 and 09 models)
	9900850012	Thermistor (Outdoor temp.) (12 and 14 models)
10	9900583019	Reactor assy (07, 09, and 12 models)
	9900963019	Reactor assy (14 model)
11	N/A	Heat sink
12	N/A	Base assy
13	9322144003	Drain pipe
14	9322555410	Front panel assy
15	N/A	Blow grille
16	0700103070	Nut
17	9322136008	Propeller fan
18	9322553010	Motor bracket assy
19	9603553005	DC fan motor
20	9323834071	Heat exchanger unit (07 and 09 models)
	9323834019	Heat exchanger unit (12 and 14 models)

N/A: Not available

Compressor

TECHNICAL DATA
AND PARTS LIST

TECHNICAL DATA
AND PARTS LIST

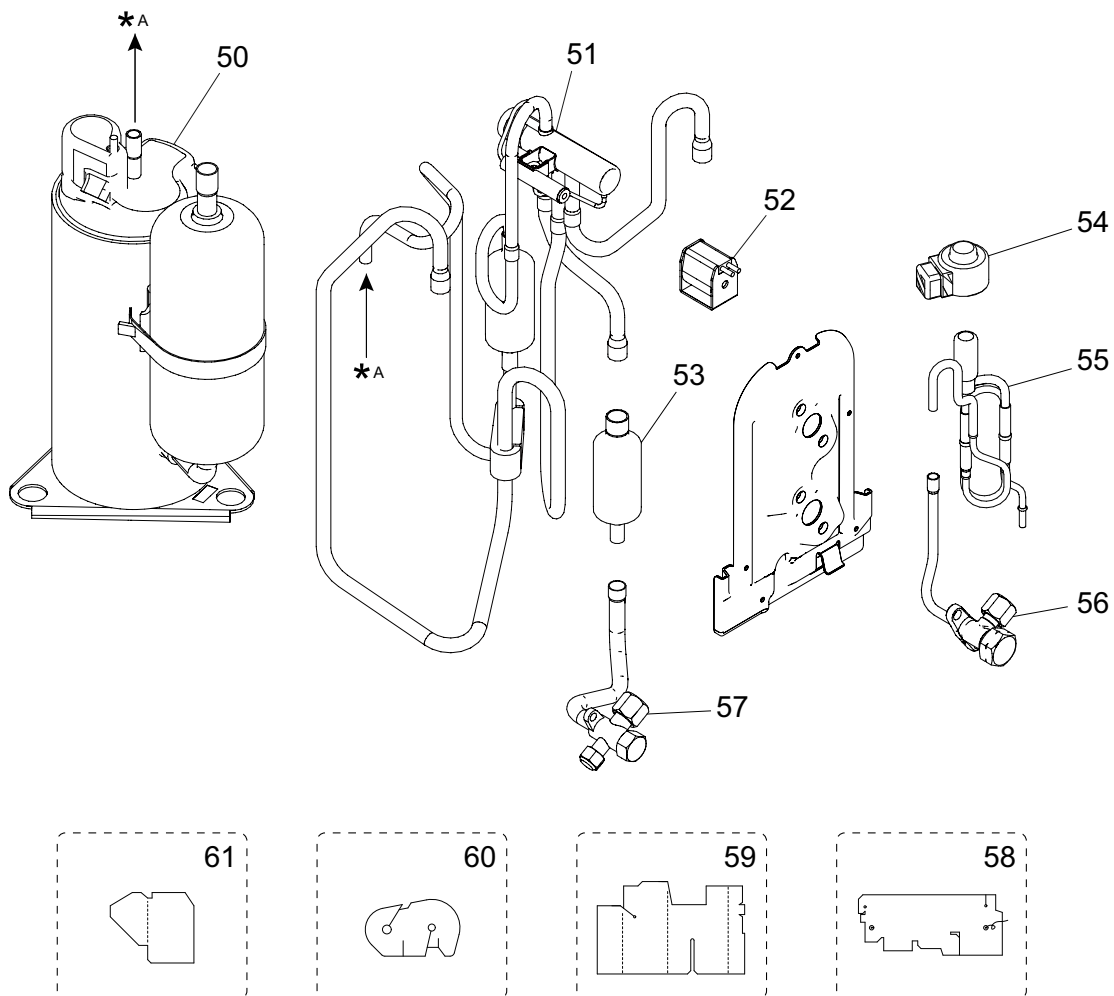







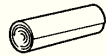

Item no.	Part no.	Part name
50	9322427007	Compressor assy (07, 09, and 12 models)
	9322429001	Compressor assy (14 model)
51	9322444004	4-way valve assy
52	9970195006	Solenoid
53	N/A	Muffler
54	9970095122	Expansion valve coil
55	9322463005	Pulse motor valve assy
56	9322474001	2-way valve assy
57	9322475008	3-way valve assy
58	N/A	Sound insulator B
59	N/A	Sound insulator F
60	N/A	Sound insulator H
61	N/A	Sound insulator V

N/A: Not available

4. Accessories

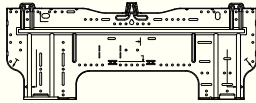
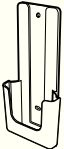

4-1. Indoor unit

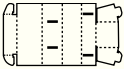
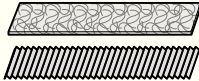
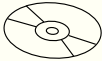
■ Models: ASEH07KGTG, ASEH09KGTG, ASEH12KGTG, and ASEH14KGTG

Part name	Exterior	Qty	Part name	Exterior	Qty
Operation manual		1	Cloth tape		1
Installation manual		1	Self-tapping screw (large)		5
Remote controller		1	Self-tapping screw (small)		2
Battery		2	Wall hook bracket		1
Remote controller holder		1	Filter holder		2
Installation spacer		1	Air cleaning filters		1
Operation manual (CD-ROM)		1			

4-2. Outdoor unit



■ Models: AOEH07KGCG, AOEH09KGCG, AOEH12KGCG, and AOEH14KGCG

Part name	Exterior	Qty	Part name	Exterior	Qty
Installation manual		1	Drain pipe		1

5. Optional parts

5-1. Indoor unit

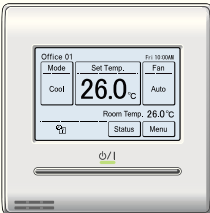
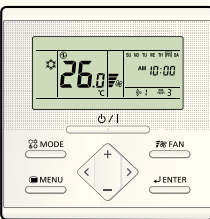

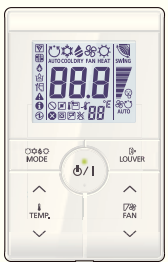
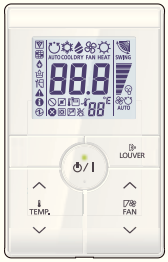



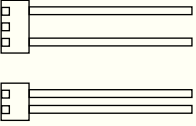
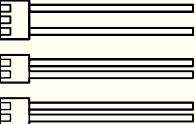

■ Controllers

Exterior	Part name	Model name	Summary
	Wired Remote Controller (Touch Panel)	UTY-RVRY	Remote controller that provides the functions you need in a sleek design that uniquely transforms itself to blend with any interior. Optional Communication Kit is necessary for installation. Optional Communication Kit is necessary for installation.
	Wired Remote Controller (Touch Panel)	UTY-RNRYZ*	Easy finger touch operation with LCD panel. Backlit LCD enables easy operation in a dark room. Optional Communication Kit is necessary for installation.
	Wired Remote Controller	UTY-RLRY	High visibility and easy operation. Room temperature can be accurately controlled using the thermo sensor. Optional Communication Kit is necessary for installation.
	Compact Wired Remote Controller	UTY-RCRYZ1	Compact body and easy operation. Room temperature can be accurately controlled using the thermo sensor. Optional Communication Kit is necessary for installation.
	Simple Remote Controller	UTY-RSRY	Compact remote controller concentrates on the basic functions such as Start/ Stop, fan control, temperature setting, and operation mode. Optional Communication Kit is necessary for installation.
	Simple Remote Controller	UTY-RHRY	Compact remote controller concentrates on the basic functions such as Start/ Stop, fan control, and temperature setting. Optional Communication Kit is necessary for installation.

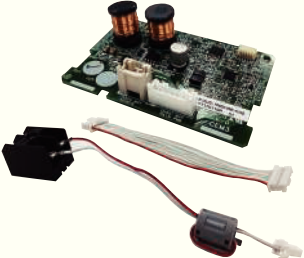
NOTES:

- Available functions may differ by the remote controller. For details, refer to the operation manual.
- When using the group controlling system of the Wired Remote Controller, using WLAN Adapter is prohibited.

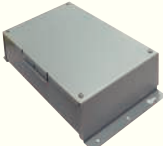
Others

Exterior	Part name	Model name	Summary
	Air Cleaning Filter	UTR-FA16-5	Air Cleaning Filter can be mounted to the indoor unit. (For antibacterial)
	External Connect Kit	UTY-XWZX	Use to connect with various peripheral devices and air conditioner PCB. Connecting point: CN46 and CN47 on Main PCB
	External Connect Kit	UTY-XWZXZ5	Required when external device is connected. Connecting point: CN46 and CN47 on Main PCB
	External Input and Output PCB	UTY-XCSXZ2	Use to connect with external devices and air conditioner PCB. Optional External Connect Kit might be required to connect locally purchased devices via this PCB. Connecting point: CN65 on Main PCB
	Communication Kit	UTY-TWRXZ2	Use to connect Non-polar 2-core wired remote controller.
	Modbus Converter	UTY-VMSX	For connection between indoor unit with UART interface and a Modbus open network. Connecting point: CN65 on Main PCB
	KNX Converter	UTY-VKSX	For connection between indoor unit with UART interface and a KNX open network. Connecting point: CN65 on Main PCB
	Network Converter	UTY-VTGX	This converter is required when connecting single split system to VRF network system. Optional Communication Kit is necessary for installation. Use the terminal for Wired Remote Controller.
	Network Converter (AC power supply)	UTY-VTGXV	This converter is required when connecting single split system to VRF network system. Optional Communication Kit is necessary for installation. Use the terminal for Wired Remote Controller.
	External Switch Controller	UTY-TERX	Air conditioner switching can be controlled by connecting other external sensor switches. Optional Communication Kit is necessary for installation. Use the terminal for Wired Remote Controller.

6. Refrigerant system diagrams

6-1. Models: AOEH07KGCG, AOEH09KGCG, AOEH12KGCG, and AOEH14KGCG

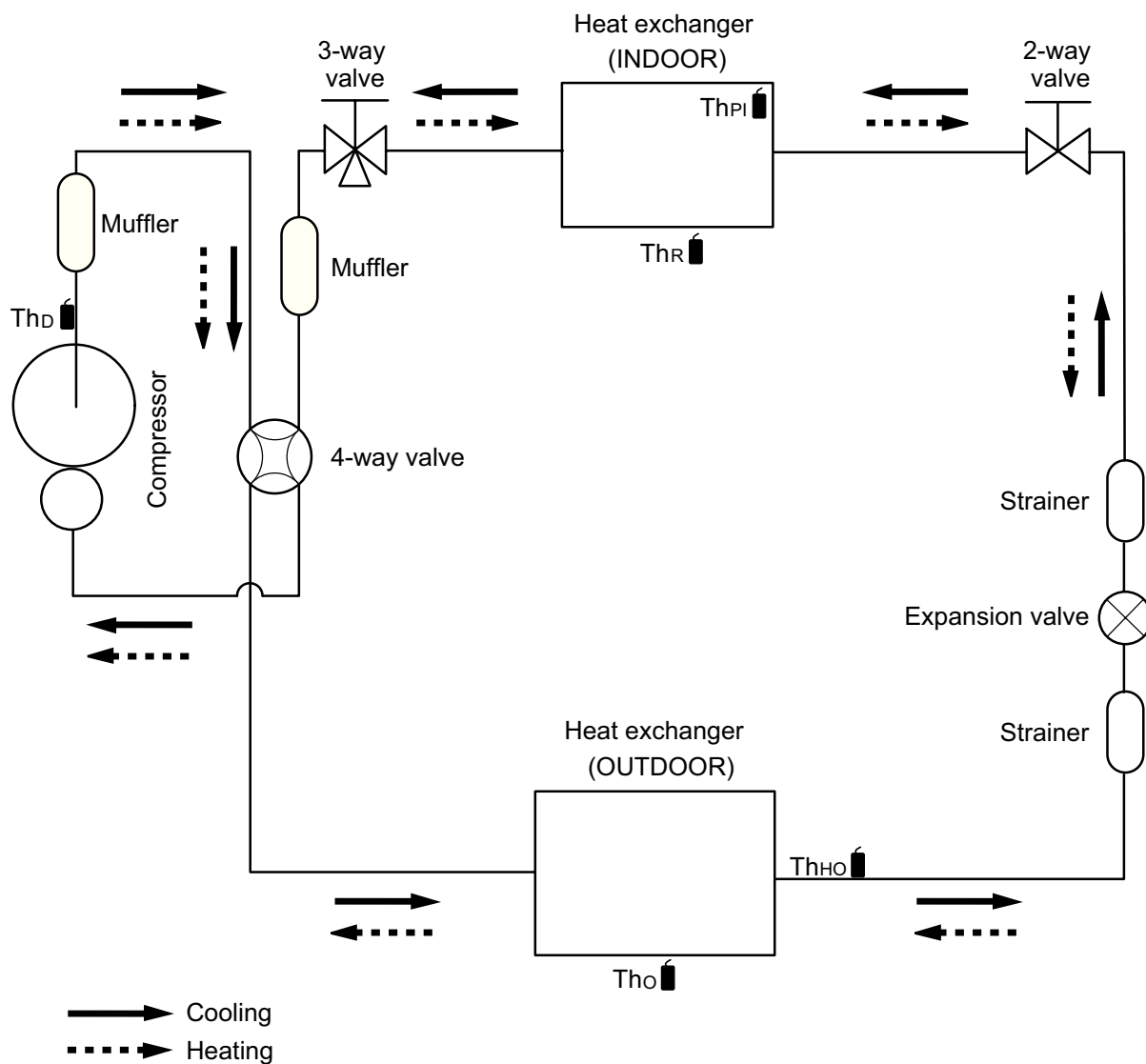

Th_D : Thermistor (Discharge temperature)

Th_O : Thermistor (Outdoor temperature)

Th_{HO} : Thermistor (Heat exchanger out temperature)

Th_{PI} : Thermistor (Pipe temperature)

Th_R : Thermistor (Room temperature)

7. Wiring diagrams

7-1. Indoor unit

Models: ASEH07KGTG, ASEH09KGTG, ASEH12KGTG, and ASEH14KGTG

TECHNICAL DATA AND PARTS LIST

TECHNICAL DATA AND PARTS LIST

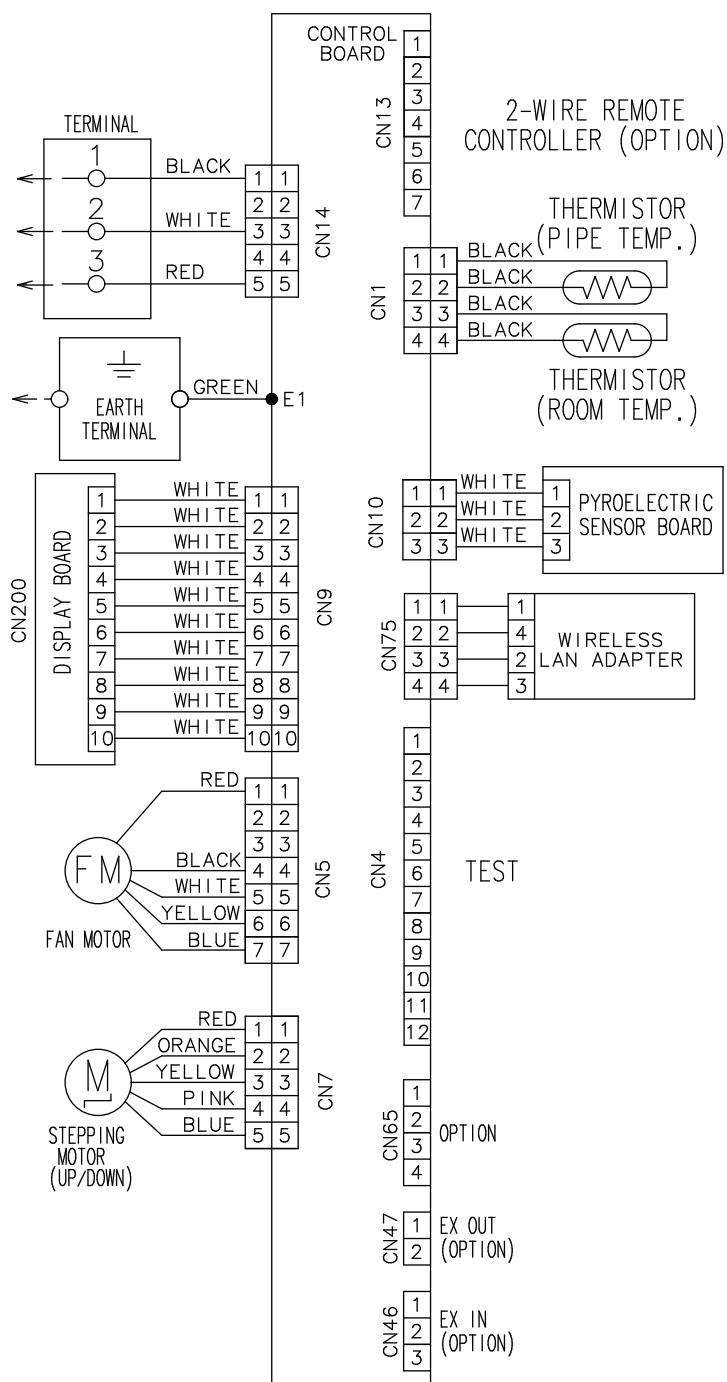

7-2. Outdoor unit

■ Models: AOEH07KGCG, AOEH09KGCG, AOEH12KGCG, and AOEH14KGCG

TECHNICAL DATA
AND PARTS LIST

TECHNICAL DATA
AND PARTS LIST

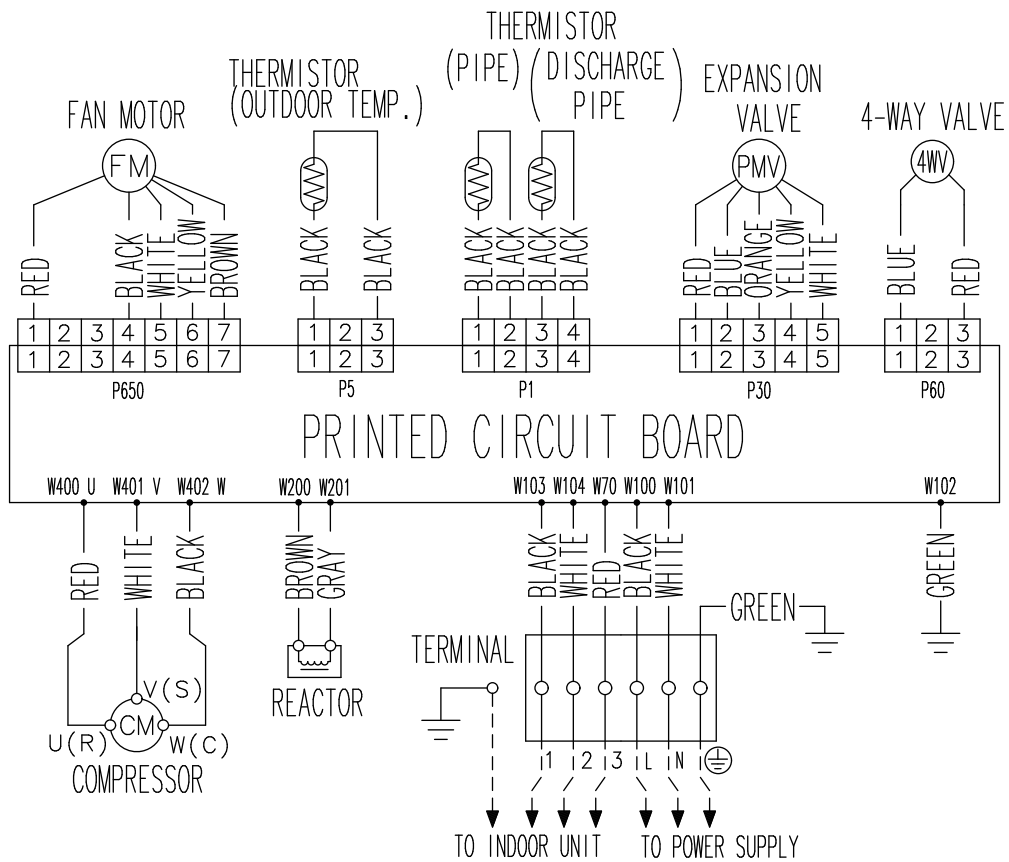

8. PC board diagrams

8-1. Models: ASEH07KGTG, ASEH09KGTG, ASEH12KGTG, and ASEH14KGTG

TECHNICAL DATA AND PARTS LIST

TECHNICAL DATA AND PARTS LIST

CONTROL UNIT
 07 model : EZ-02314HSE
 09 model : EZ-02315HSE
 12 model : EZ-02316HSE
 14 model : EZ-02317HSE

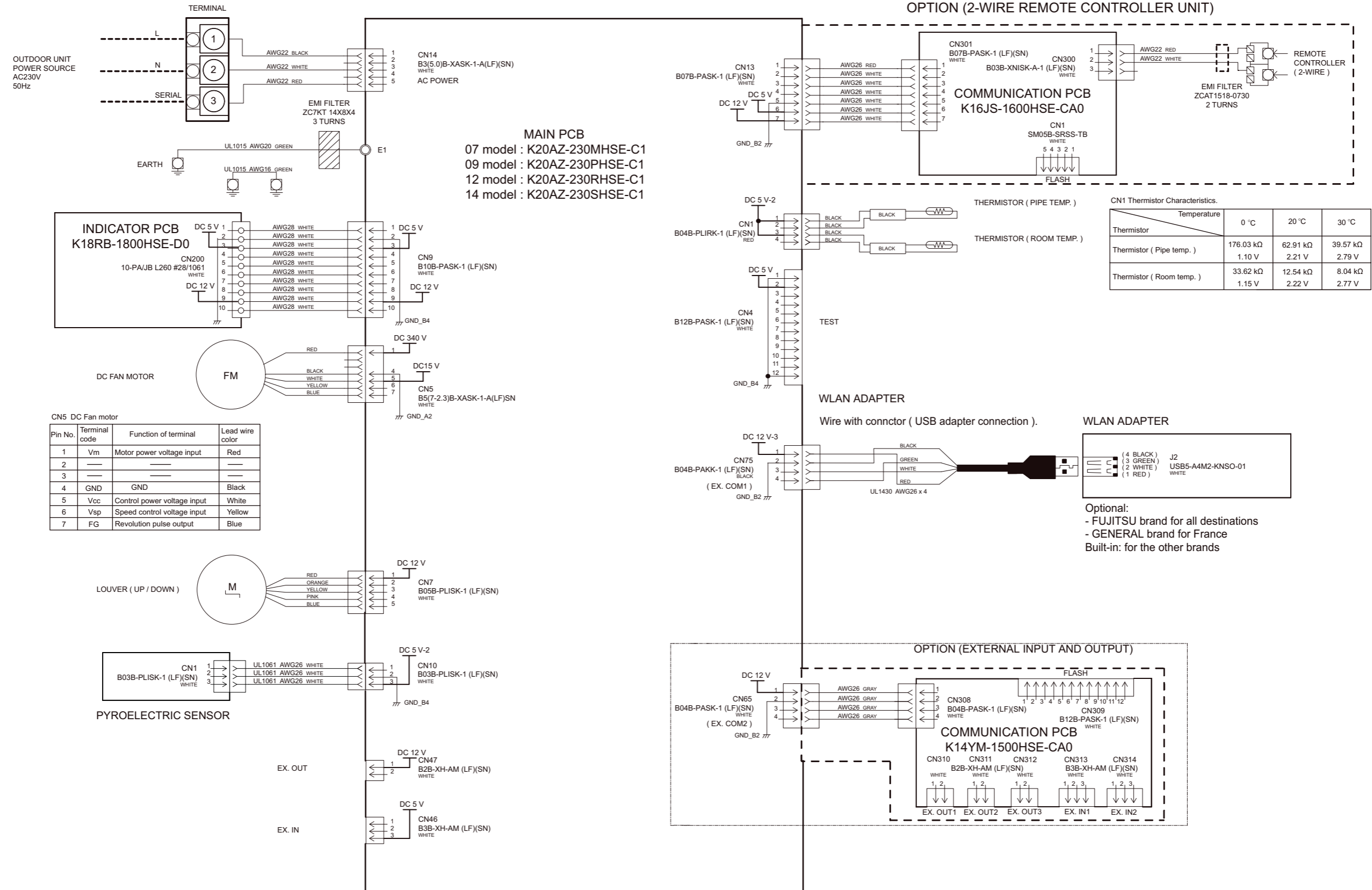

CN5 DC Fan motor

Pin No.	Terminal code	Function of terminal	Lead wire color
1	Vm	Motor power voltage input	Red
2	—	—	—
3	—	—	—
4	GND	GND	Black
5	Vcc	Control power voltage input	White
6	Vsp	Speed control voltage input	Yellow
7	FG	Revolution pulse output	Blue

CN1 Thermistor Characteristics.

Temperature	0 °C	20 °C	30 °C
Thermistor	176.03 kΩ	62.91 kΩ	39.57 kΩ
Thermistor (Pipe temp.)	1.10 V	2.21 V	2.79 V
Thermistor (Room temp.)	33.62 kΩ	12.54 kΩ	8.04 kΩ
	1.15 V	2.22 V	2.77 V

8-2. Models: AOEH07KGCG, AOEH09KGCG, AOEH12KGCG, and AOEH14KGCG

CONTROL UNIT
 07, 09, 12 models: EZ-023THUE
 14 model: EZ-023WHUE

TECHNICAL DATA
AND PARTS LIST

TECHNICAL DATA
AND PARTS LIST

TO INDOOR UNIR

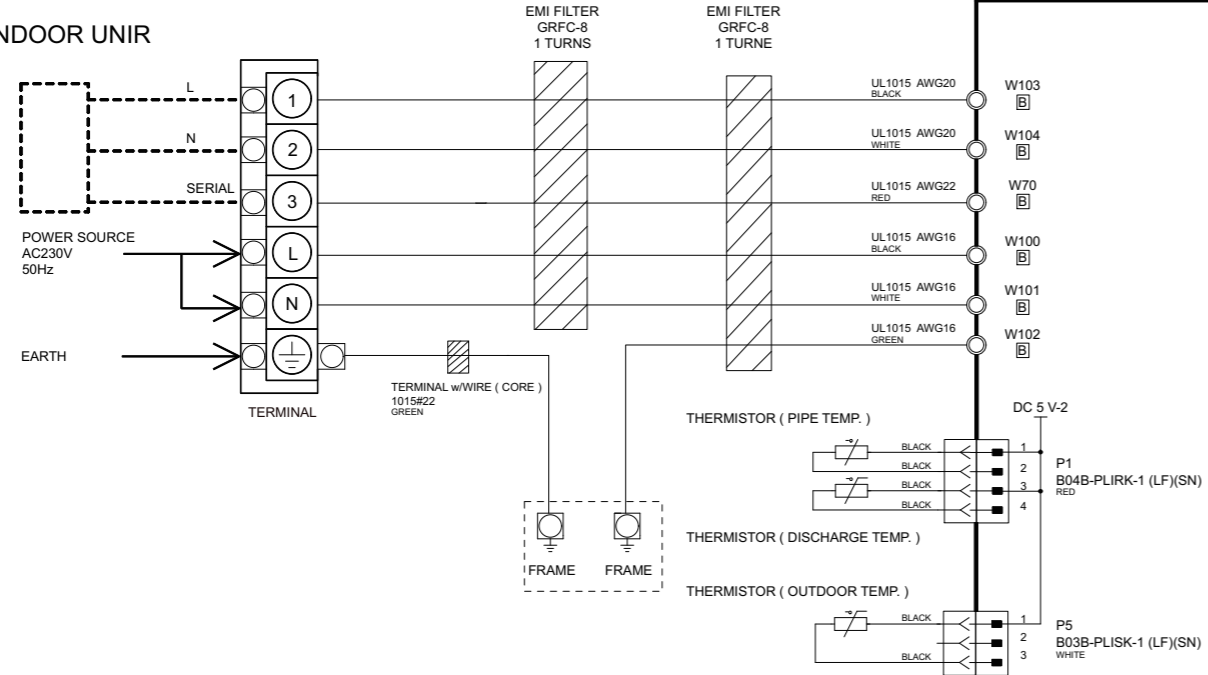

P1 Thermistor Characteristics.

Thermistor	Temperature	0 °C	20 °C	30 °C
Thermistor (Pipe temp.)	Resistance	16.05 kΩ	5.98 kΩ	3.84 kΩ
	Voltage	1.14 V	2.21 V	2.77 V
Thermistor (Discharge temp.)	Resistance	168.60 kΩ	62.55 kΩ	40.01 kΩ
	Voltage	0.36 V	0.86 V	1.23 V

P5 Thermistor Characteristics.

Thermistor	Temperature	0 °C	20 °C	30 °C
Thermistor (Outdoor temp.)	Resistance	35.21 kΩ	12.64 kΩ	7.97 kΩ
	Voltage	2.61 V	3.76 V	4.14 V

MAIN PCB
 07 model: H07KGCG(E)-A01-00-SV
 09 model: H09KGCG(E)-A01-00-SV
 12 model: H12KGCG(E)-A01-00-SV
 14 model: H14KGCG(E)-A01-00-SV

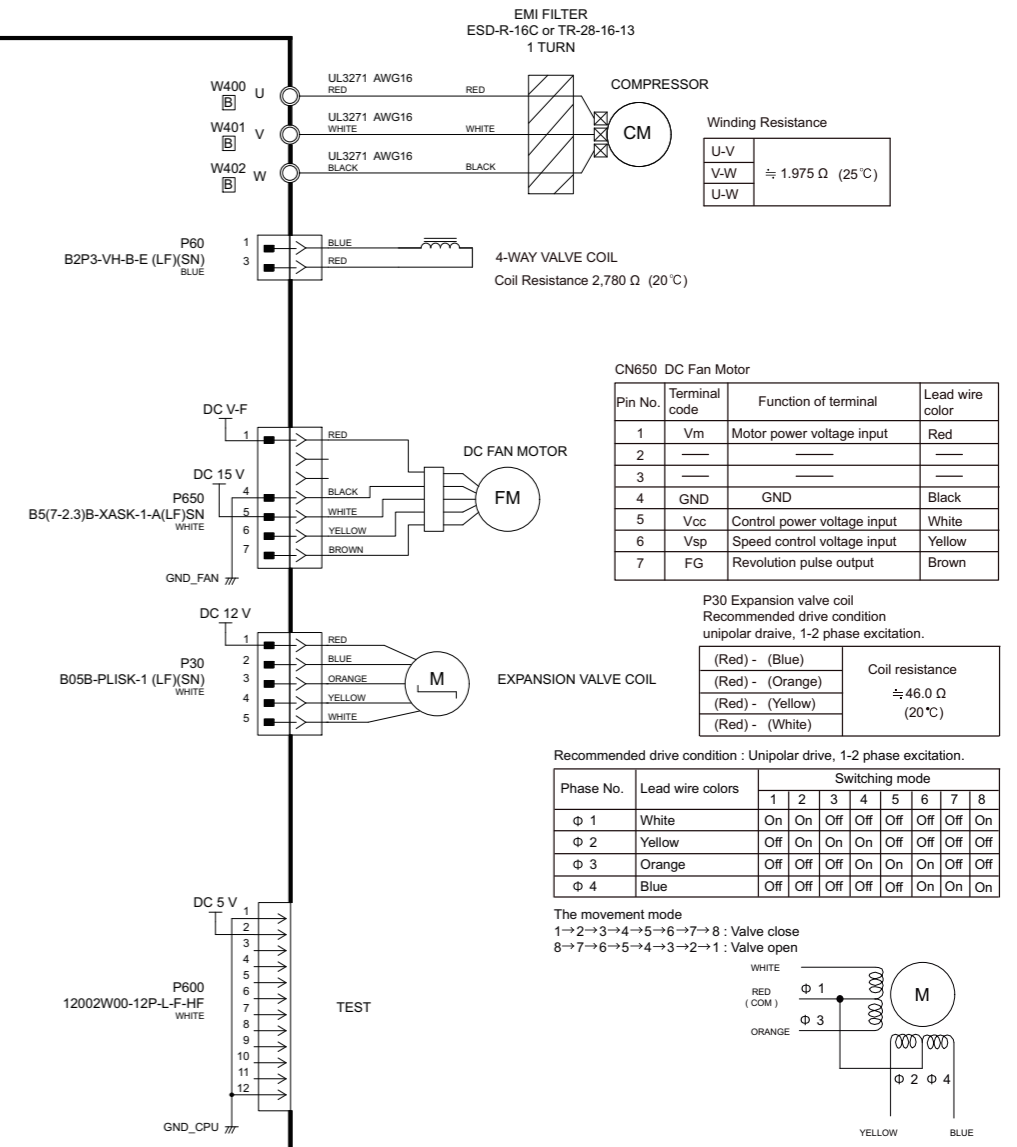

Winding Resistance

U-V	≈ 1.975 Ω (25 °C)
V-W	
U-W	

CN650 DC Fan Motor

Pin No.	Terminal code	Function of terminal	Lead wire color
1	Vm	Motor power voltage input	Red
2			
3			
4	GND	GND	Black
5	Vcc	Control power voltage input	White
6	Vsp	Speed control voltage input	Yellow
7	FG	Revolution pulse output	Brown

P30 Expansion valve coil
 Recommended drive condition
 unipolar drive, 1-2 phase excitation.

(Red) - (Blue)	Coil resistance ≈ 46.0 Ω (20 °C)
(Red) - (Orange)	
(Red) - (Yellow)	
(Red) - (White)	

Recommended drive condition : Unipolar drive, 1-2 phase excitation.

Phase No.	Lead wire colors	Switching mode							
		1	2	3	4	5	6	7	8
Φ 1	White	On	On	Off	Off	Off	Off	Off	On
Φ 2	Yellow	Off	On	On	On	Off	Off	Off	Off
Φ 3	Orange	Off	Off	Off	On	On	On	Off	Off
Φ 4	Blue	Off	Off	Off	Off	Off	On	On	On

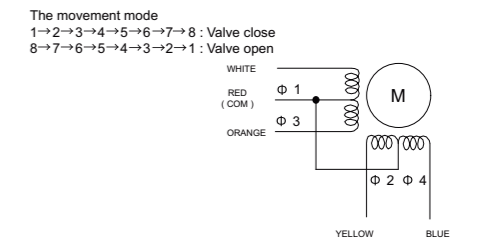

3. TROUBLESHOOTING

CONTENTS

3. TROUBLESHOOTING

1. Error code	03-1
1-1. How to check the error memory.....	03-1
1-2. How to erase the error memory	03-1
1-3. Error code table (Indoor unit and wired remote controller).....	03-2
1-4. Error code table (Wireless LAN indicator).....	03-4
1-5. How to check the error code on Mobile app	03-5
1-6. Error code table (Mobile app)	03-6
1-7. Error message for wireless LAN control (Mobile app).....	03-8
2. Troubleshooting with error code	03-22
2-1. E: 11. Serial communication error (Serial reverse transfer error) (Outdoor unit).....	03-22
2-2. E: 11. Serial communication error (Serial forward transfer error) (Indoor unit)	03-24
2-3. E: 12. Wired remote controller communication error (Indoor unit)	03-26
2-4. E: 18. External communication error (Indoor unit)	03-27
2-5. E: 22. Indoor unit capacity error (Indoor unit)	03-28
2-6. E: 23. Combination error (Outdoor unit).....	03-29
2-7. E: 26. Address setting error in wired remote controller (Indoor unit).....	03-30
2-8. E: 29. Connected unit number error (Indoor unit)	03-31
2-9. E: 32. Indoor unit main PCB error (Indoor unit)	03-32
2-10. E: 33. Indoor unit motor electricity consumption detection error (Indoor unit).....	03-33
2-11. E: 35. MANUAL AUTO button error (Indoor unit).....	03-34
2-12. E: 39. Indoor unit power supply error for fan motor (Indoor unit)	03-35
2-13. E: 3A. Indoor unit communication circuit (wired remote controller) error	03-36
2-14. E: 41. Room temperature sensor error (Indoor unit).....	03-37
2-15. E: 42. Indoor unit heat exchanger sensor error (Indoor unit)	03-38
2-16. E: 44. Human sensor error	03-39
2-17. E: 51. Indoor unit fan motor error (Indoor unit)	03-40
2-18. E: 5U. Indoor unit error	03-41
2-19. E: 62. Outdoor unit main PCB error (Outdoor unit).....	03-42
2-20. E: 64. PFC circuit error (Outdoor unit)	03-43
2-21. E: 65. IPM error (Outdoor unit)	03-44
2-22. E: 71. Discharge thermistor error (Outdoor unit).....	03-46
2-23. E: 73. Outdoor unit heat exchanger liquid outlet thermistor error (Outdoor unit).....	03-47
2-24. E: 74. Outdoor temperature thermistor error (Outdoor unit).....	03-48
2-25. E: 84. Current sensor error (Outdoor unit)	03-49
2-26. E: 94. Over current error (Outdoor unit).....	03-51
2-27. E: 95. Compressor motor control error (Outdoor unit)	03-52
2-28. E: 97. Outdoor unit fan motor error (Outdoor unit).....	03-53
2-29. E: 99. 4-way valve error (Outdoor unit).....	03-55
2-30. E: A1. Discharge temperature error (Outdoor unit).....	03-57
3. Troubleshooting without error code	03-59
3-1. Indoor unit—No power.....	03-59
3-2. Outdoor unit—No power	03-60

CONTENTS (continued)

3-3. No operation (Power is on)	03-61
3-4. No cooling/No heating	03-62
3-5. Abnormal noise.....	03-64
3-6. Water leaking.....	03-65
4. Troubleshooting with error code (For wireless LAN adapter).....	03-66
4-1. E: 18. External communication error between indoor unit and wireless LAN adapter...03-66	
4-2. Network communication error between wireless LAN router and wireless LAN adapter	03-67
4-3. E: 18. Communication error.....	03-69
4-4. E: 18. Wireless LAN adapter non-energized.....	03-71
4-5. Mobile app setting method.....	03-72
5. Service parts information	03-74
5-1. Compressor	03-74
5-2. Inverter compressor.....	03-75
5-3. Outdoor unit Electronic Expansion Valve (EEV)	03-76
5-4. Indoor unit fan motor	03-78
5-5. Outdoor unit fan motor	03-79
5-6. Reactor assy.....	03-80
5-7. 4-way valve coil (solenoid coil)/4-way valve	03-81
6. Thermistor resistance values.....	03-82
6-1. Indoor unit	03-82
6-2. Outdoor unit.....	03-83

1. Error code

When a problem occurs in the system or the connected device, the error content is notified by displaying the code.

NOTE: This function is only available in a system with indoor or IR receiver units equipped with indicator lamps to show the error content.

Errors, once displayed, will be automatically stored in the PC board of the indoor unit. Even if the power is disconnected, the memory containing the error history will not be erased.

If another error occurs later, the stored error memory will be updated automatically and replaced with the new one. (Previous error will be erased.)

1-1. How to check the error memory

When an error occurs, the operation lamp (Green) and the timer lamp (Orange) indicate the error content by blinking. To check the error memory, follow the procedures below.

1. Stop the operation of the air conditioner, and then disconnect the power supply.
2. Reconnect the power supply.
3. In one of the following two methods, the memorized error is only displayed during the “3 minutes ST”^{*} state period.
 - Start the operation and then press the TEST RUN button on the remote controller.
 - Press the MANUAL AUTO button on the indoor unit for 10 seconds or more.

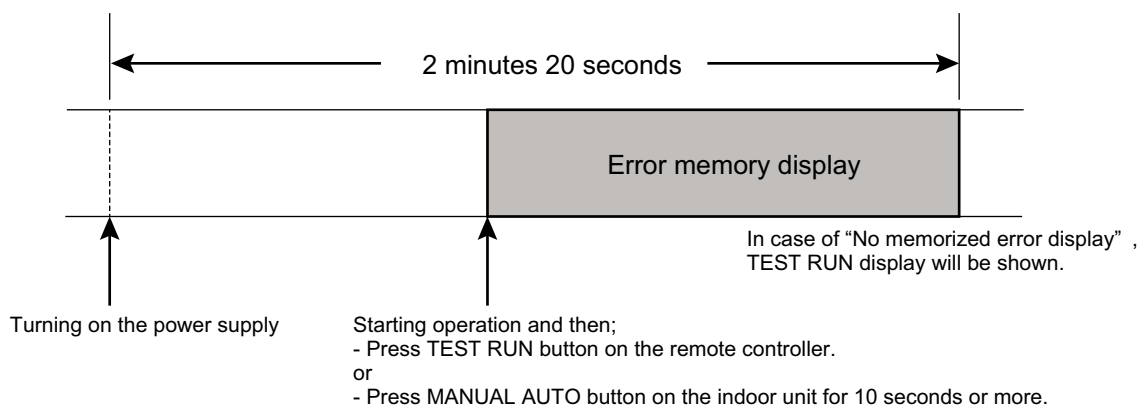

*: The “3 minutes ST” period lasts 2 minutes and 20 seconds after turning on the power supply.

1-2. How to erase the error memory

The error memory can be erased in one of the following two methods.

- Manual erase: Pressing the MANUAL AUTO button on the indoor unit while the “Error memory display” is being shown. (Short beep emits for about 3 seconds.)
- Automatic erase: After continuing the normal operation of the air conditioner without error for 2 hours or longer after displaying the error memory as described in [How to check the error memory](#). (Except FAN operation mode.)

1-3. Error code table (Indoor unit and wired remote controller)

The operation, timer, and economy indicators operate according to the error contents.

For confirmation of the error contents, refer the flashing pattern as follows.

Error contents	Indoor unit display			Wired remote controller display
	Operation [I] (Green)	Timer [⌚] (Orange)	Economy [E] (Green)	
E: 11. Serial communication error (Serial reverse transfer error) (Outdoor unit)	1 times	1 times	Continuous	11
E: 11. Serial communication error (Serial forward transfer error) (Indoor unit)	1 times	1 times	Continuous	11
E: 12. Wired remote controller communication error (Indoor unit)	1 times	2 times	Continuous	12
E: 18. External communication error (Indoor unit)	1 times	8 times	Continuous	18
E: 18. External communication error between indoor unit and wireless LAN adapter	1 times	8 times	Continuous	18
E: 18. Communication error	1 times	8 times	Continuous	18
E: 18. Wireless LAN adapter non-energized	1 times	8 times	Continuous	18
E: 22. Indoor unit capacity error (Indoor unit)	2 times	2 times	Continuous	22
E: 23. Combination error (Outdoor unit)	2 times	3 times	Continuous	23
E: 26. Address setting error in wired remote controller (Indoor unit)	2 times	6 times	Continuous	26
E: 29. Connected unit number error (Indoor unit)	2 times	9 times	Continuous	29
E: 32. Indoor unit main PCB error (Indoor unit)	3 times	2 times	Continuous	32
E: 33. Indoor unit motor electricity consumption detection error (Indoor unit)	3 times	3 times	Continuous	33
E: 35. MANUAL AUTO button error (Indoor unit)	3 times	5 times	Continuous	35
E: 39. Indoor unit power supply error for fan motor (Indoor unit)	3 times	9 times	Continuous	39
E: 3A. Indoor unit communication circuit (wired remote controller) error	3 times	10 times	Continuous	3A
E: 41. Room temperature sensor error (Indoor unit)	4 times	1 times	Continuous	41
E: 42. Indoor unit heat exchanger sensor error (Indoor unit)	4 times	2 times	Continuous	42
E: 44. Human sensor error	4 times	4 times	Continuous	44
E: 51. Indoor unit fan motor error (Indoor unit)	5 times	1 times	Continuous	51
E: 5U. Indoor unit error	5 times	15 times	Continuous	5U
E: 62. Outdoor unit main PCB error (Outdoor unit)	6 times	2 times	Continuous	62
E: 64. PFC circuit error (Outdoor unit)	6 times	4 times	Continuous	64
E: 65. IPM error (Outdoor unit)	6 times	5 times	Continuous	65
E: 71. Discharge thermistor error (Outdoor unit)	7 times	1 times	Continuous	71
E: 73. Outdoor unit heat exchanger liquid outlet thermistor error (Outdoor unit)	7 times	3 times	Continuous	73
E: 74. Outdoor temperature thermistor error (Outdoor unit)	7 times	4 times	Continuous	74
E: 84. Current sensor error (Outdoor unit)	8 times	4 times	Continuous	84
E: 94. Over current error (Outdoor unit)	9 times	4 times	Continuous	94

Error contents	Indoor unit display			Wired remote controller display
	Operation [I] (Green)	Timer [⌚] (Orange)	Economy [E] (Green)	
E: 95. Compressor motor control error (Outdoor unit)	9 times	5 times	Continuous	95
E: 97. Outdoor unit fan motor error (Outdoor unit)	9 times	7 times	Continuous	97
E: 99. 4-way valve error (Outdoor unit)	9 times	9 times	Continuous	99
E: A1. Discharge temperature error (Outdoor unit)	10 times	1 times	Continuous	A1

1-4. Error code table (Wireless LAN indicator)

- Wireless LAN control system diagram example

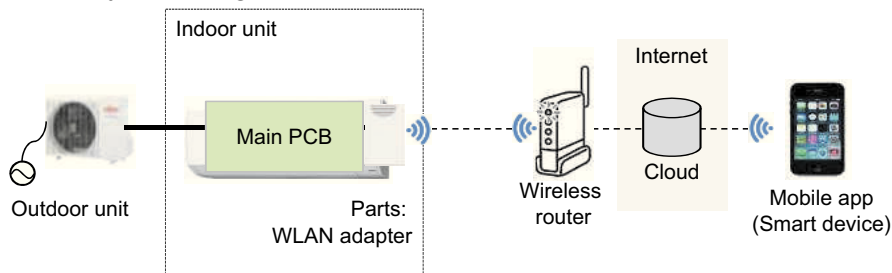

- Name of parts

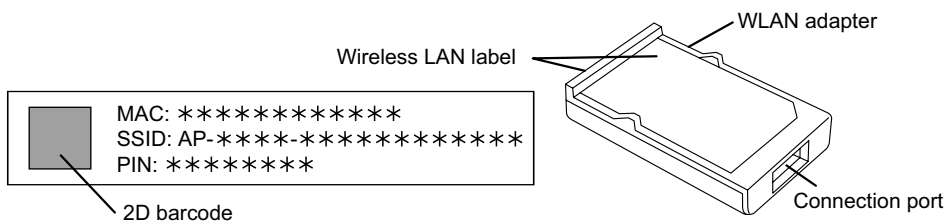

- Wireless LAN indicator lamps

For confirmation of the error contents, refer to the following flashing patterns.

Wireless LAN indicator lamp (orange) on the indoor unit operate according to the error contents.

Error contents	Wireless LAN indicator lamp (orange)	Error code
E: 18. External communication error between indoor unit and wireless LAN adapter	Flashing slowly	18
Network communication error between wireless LAN router and wireless LAN adapter	Flashing slowly	No error
E: 18. Communication error	Flashing slowly	18
E: 18. Wireless LAN adapter non-energized	Off	18

Flashing slowly: Repeating 7 seconds on/2 seconds off

TROUBLESHOOTING

TROUBLESHOOTING

1-5. How to check the error code on Mobile app

If there is an abnormality on the air conditioning, refer to  as follows.

When the  (error button) on the home screen is tapped, error code and error name is displayed.

TROUBLESHOOTING

TROUBLESHOOTING

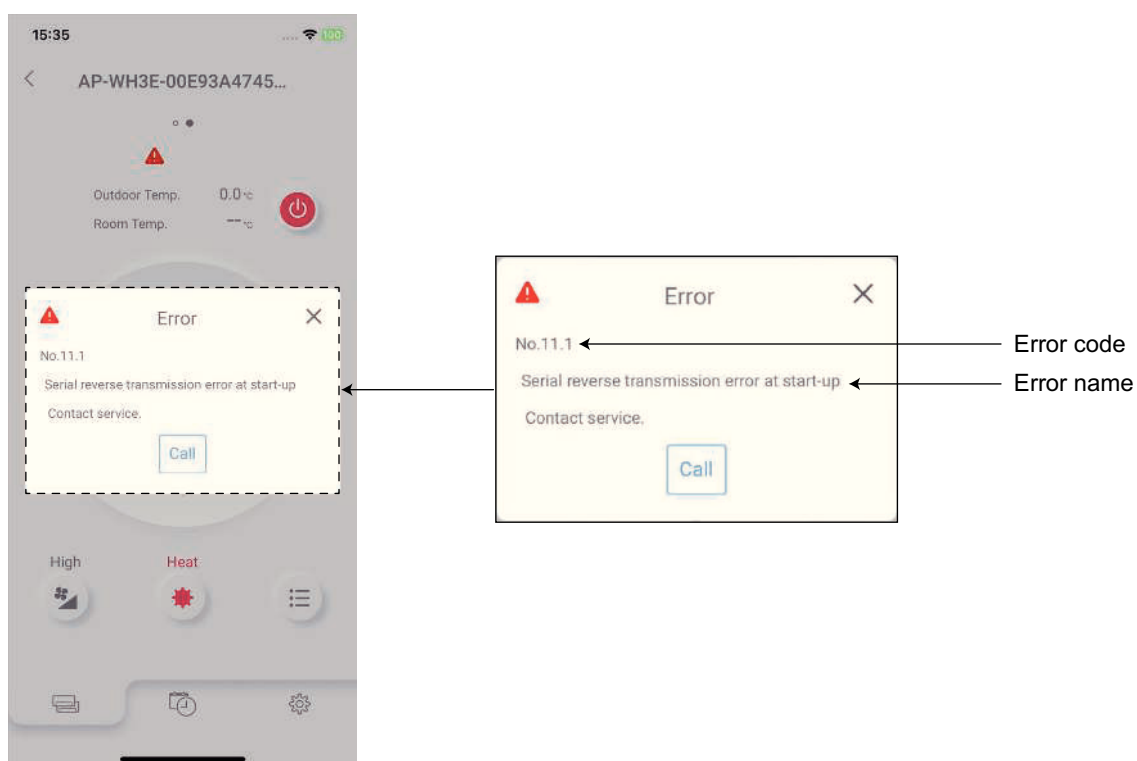
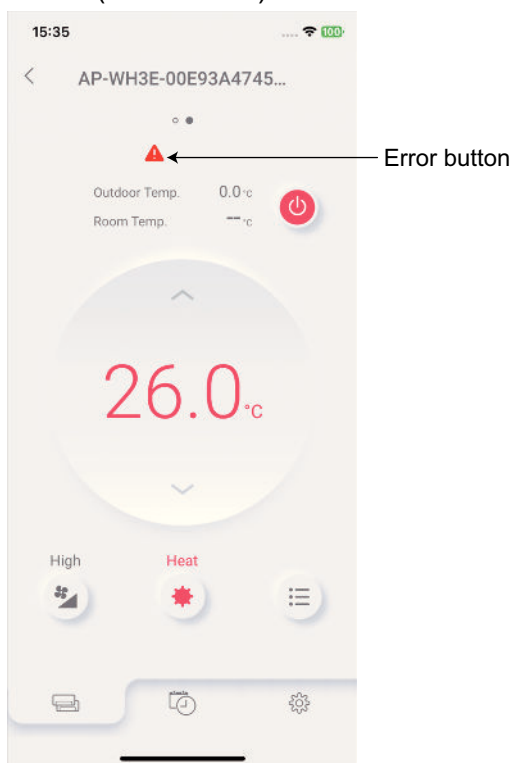

1-6. Error code table (Mobile app)

Error message	Error contents	Error code
Serial reverse transmission error at start-up	E: 11. Serial communication error (Serial reverse transfer error) (Outdoor unit)	11.1
Serial reverse transmission error during operation		11.2
Serial forward transmission error at start-up	E: 11. Serial communication error (Serial forward transfer error) (Indoor unit)	11.3
Serial forward transmission error during operation		11.4
External communication 1 error	E: 18. External communication error (Indoor unit)	18.1
Indoor unit capacity error	E: 22. Indoor unit capacity error (Indoor unit)	22.1
Connection forbidden (series error)	E: 23. Combination error (Outdoor unit)	23.1
Unit combination error		23.2
Address duplication in wired remote controller system	E: 26. Address setting error in wired remote controller (Indoor unit)	26.4
Address setting error in wired remote controller system		26.5
Connection unit number error (indoor unit in wired remote controller system)	E: 29. Connected unit number error (Indoor unit)	29.1
Indoor unit PCB model information error	E: 32. Indoor unit main PCB error (Indoor unit)	32.1
Constant correction control error		32.6
Indoor unit motor electricity consumption detection microcomputers error	E: 33. Indoor unit motor electricity consumption detection error (Indoor unit)	33.2
Indoor unit manual auto switch error	E: 35. MANUAL AUTO button error (Indoor unit)	35.1
Indoor unit power supply error for fan motor 1	E: 39. Indoor unit power supply error for fan motor (Indoor unit)	39.1
Indoor unit communication circuit (wired remote controller) microcomputers communication error	E: 3A. Indoor unit communication circuit (wired remote controller) error	3A.1
Indoor unit suction air temp. thermistor error	E: 41. Room temperature sensor error (Indoor unit)	41.1
Indoor unit heat ex. middle temp. thermistor error	E: 42. Indoor unit heat exchanger sensor error (Indoor unit)	42.2
Human detection sensor error	E: 44. Human sensor error	44.1
Indoor unit fan motor 1 lock error	E: 51. Indoor unit fan motor error (Indoor unit)	51.1
Indoor unit fan motor 1 rotation speed error		51.2
Outdoor unit PCB model information error	E: 62. Outdoor unit main PCB error (Outdoor unit)	62.1
Outdoor unit PCB microcomputer communication error		62.2
Outdoor unit abnormal voltage error (permanent stop)	E: 64. PFC circuit error (Outdoor unit)	64.1
Outdoor unit abnormal voltage error (automatic restore)		64.3
Outdoor unit over current error (permanent stop)		64.4
Outdoor unit PFC hardware error		64.8
Outdoor unit trip terminal L error	E: 65. IPM error (Outdoor unit)	65.3
Outdoor unit discharge temp. thermistor 1 error	E: 71. Discharge thermistor error (Outdoor unit)	71.1
Outdoor unit heat ex. liquid temp. thermistor error	E: 73. Outdoor unit heat exchanger liquid outlet thermistor error (Outdoor unit)	73.3
Outside air temp. thermistor error	E: 74. Outdoor temperature thermistor error (Outdoor unit)	74.1
Outdoor unit current sensor 1 error (permanent stop)	E: 84. Current sensor error (Outdoor unit)	84.1
Outdoor unit trip detection	E: 94. Over current error (Outdoor unit)	94.1

Error message	Error contents	Error code
Outdoor unit compressor rotor position detection error (permanent stop)	E: 95. Compressor motor control error (Outdoor unit)	95.1
Outdoor unit fan motor 1 power source duty error	E: 97. Outdoor unit fan motor error (Outdoor unit)	97.3
Outdoor unit 4-way valve error	E: 99. 4-way valve error (Outdoor unit)	99.1
Outdoor unit discharge temperature 1 error (permanent stop)	E: A1. Discharge temperature error (Outdoor unit)	A1.1

1-7. Error message for wireless LAN control (Mobile app)

■ Error display

If there is an abnormality on the wireless control system, refer to error messages as follows.

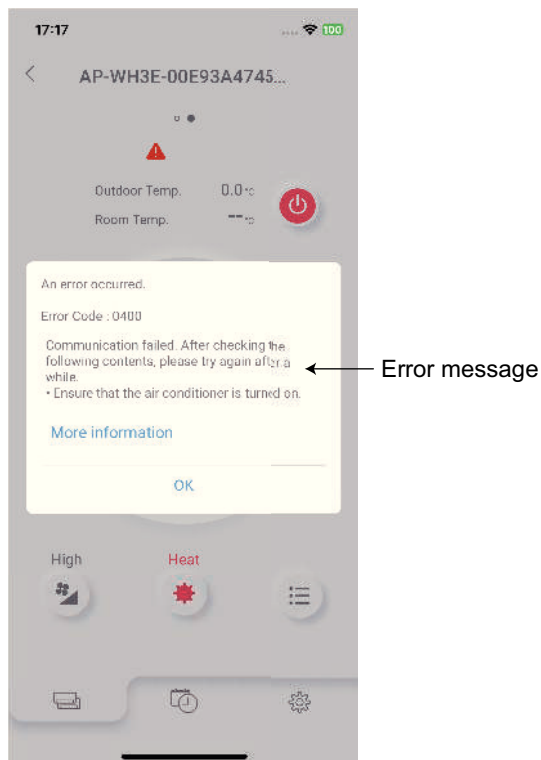

■ Error message list

- Registration error

Error code	Error message	Cause
		Solution
2400	<p>Communication failed. After checking the following contents, please try again after a while.</p> <ul style="list-style-type: none"> • Ensure that the air conditioner is turned on. 	<p>Communication with the air conditioner failed.</p> <p>Check the following contents depending on the status of indoor unit wireless LAN indicator lamp or WLAN Adapter LED 2 and operate again.</p> <ul style="list-style-type: none"> • When not lighting <ul style="list-style-type: none"> – Check that the Electrical panel (Switch breaker) to the air conditioner is turned on. – Check that the power plug of the air conditioner main unit is plugged in. • When lighting <p>Use a smartphone to check that the wireless router to which the air conditioner is connected is connected to the Internet. If the smartphone cannot connect to the Internet, reboot the wireless router. When rebooting the wireless router does not solve the problem, contact the manufacturer of the wireless router.</p> • When blinking <p>Wait for a while until the indicator lamp lights and then operate again. If the indicator lamp is still blinking after waiting for a while, check that the wireless router is turned on.</p>
		<p>Failed because the smartphone could not connect to the air conditioner.</p> <p>Check the following contents depending on the status of indoor unit wireless LAN indicator lamp or WLAN Adapter LED 2 and operate again.</p> <ul style="list-style-type: none"> • When not lighting <ol style="list-style-type: none"> 1. Check that the 2D barcode is for the air conditioner to be registered. 2. Check that the Electrical panel (Switch breaker) to the air conditioner is turned on. 3. Check that the power plug of the air conditioner main unit is plugged in. 4. Retry the connection step procedure for the air conditioner registration displayed in the application to set the lamp to the blinking state. • When lighting or blinking <ol style="list-style-type: none"> 1. Check that the 2D barcode is for the air conditioner to be registered. 2. Check that the wireless LAN setting of smartphone is set to ON.
2930	<p>Cannot connect to your air conditioner. Check if the WiFi setting of the mobile device is turned on.</p> <p>When problems are not resolved, there may be other causes. Tap the link below to check other solutions.</p>	<p>Failed because the smartphone could not connect to the air conditioner.</p> <p>Check the following contents depending on the status of indoor unit wireless LAN indicator lamp or WLAN Adapter LED 2 and operate again.</p> <ul style="list-style-type: none"> • When not lighting <ol style="list-style-type: none"> 1. Check that the 2D barcode is for the air conditioner to be registered. 2. Check that the Electrical panel (Switch breaker) to the air conditioner is turned on. 3. Check that the power plug of the air conditioner main unit is plugged in. 4. Retry the connection step procedure for the air conditioner registration displayed in the application to set the lamp to the blinking state. • When lighting or blinking <ol style="list-style-type: none"> 1. Check that the 2D barcode is for the air conditioner to be registered. 2. Check that the wireless LAN setting of smartphone is set to ON.
		<p>Failed because the smartphone could not connect to the air conditioner.</p> <p>Check the following contents depending on the status of indoor unit wireless LAN indicator lamp or WLAN Adapter LED 2 and operate again.</p> <ul style="list-style-type: none"> • When not lighting <ol style="list-style-type: none"> 1. Check that the 2D barcode is for the air conditioner to be registered. 2. Check that the Electrical panel (Switch breaker) to the air conditioner is turned on. 3. Check that the power plug of the air conditioner main unit is plugged in. 4. Retry the connection step procedure for the air conditioner registration displayed in the application to set the lamp to the blinking state. • When lighting or blinking <ol style="list-style-type: none"> 1. Check that the 2D barcode is for the air conditioner to be registered. 2. Check that the wireless LAN setting of smartphone is set to ON.

Error code	Error message	Cause
		Solution
2931	WLAN adapter password is wrong. Enter it again. When problems are not resolved, there may be other causes. Tap the link below to check other solutions.	Failed because the smartphone could not connect to the air conditioner. Check the following contents depending on the status of indoor unit wireless LAN indicator lamp or WLAN Adapter LED 2 and operate again.
		<ul style="list-style-type: none"> • When not lighting <ol style="list-style-type: none"> 1. Check that the Electrical panel (Switch breaker) to the air conditioner is turned on. 2. Check that the power plug of the air conditioner main unit is plugged in. 3. Retry the connection step procedure for the air conditioner registration displayed in the application to set the lamp to the blinking state. • When lighting or blinking <ol style="list-style-type: none"> 1. Check that the entered SSID and PIN numbers of WLAN Adapter are correct. 2. Check that the wireless LAN setting of smartphone is set to ON.
2932 2933	Failed to connect to wireless router. Check if the WiFi setting of the mobile device is turned on. When problems are not resolved, there may be other causes. Tap the link below to check other solutions.	<ul style="list-style-type: none"> • Registration failed because the smartphone cannot connect to the network. • Connection to the WLAN Adapter was disconnected during processing.
		<ol style="list-style-type: none"> 1. Check that the wireless LAN setting of smartphone is set to ON. 2. Check that the smartphone is connected to the Internet.
2934	Wi-Fi router password is wrong. Tap “From the beginning” to enter it again. When problems are not resolved, there may be other causes. Tap the link below to check other solutions.	<ul style="list-style-type: none"> • The wireless router password is not correct. • The air conditioner is not connected to the same wireless router as the smartphone.
		Check the following contents and operate again. <ol style="list-style-type: none"> 1. Check that the wireless router password is correct. 2. Check that the smartphone and the air conditioner are connected to the same wireless router. 3. The wireless router encryption method WPA3 is not supported. Check if SSID other than WPA3 is selected. 4. Check that the local network setting of the smartphone is “Enabled”. (Only for smartphones with iOS14 or later)
2935 2937 2939 2941	Failed to register the air conditioner. Make sure the wireless router is connected to the Internet, and then tap “Re-register” to perform the registration process again. When problems are not resolved, there may be other causes. Tap the link below to check other solutions.	Registration failed because the air conditioner cannot connect to the Internet.
		Check the following contents and operate again. <ol style="list-style-type: none"> 1. Use a smartphone to check that the wireless router to which the air conditioner is connected is connected to the Internet. 2. If the smartphone cannot connect to the Internet, reboot the wireless router. When rebooting the wireless router does not solve the problem, contact the manufacturer of the wireless router. 3. Check that the MAC address filter and privacy separator settings are not “enabled” on the wireless router.

Error code	Error message	Cause
		Solution
2936 2940	Air conditioner registration failed. Tap "Re-register" and conduct the registration processing again. If not successful after multiple attempts, tap "From the beginning" and then initialize the WLAN and start over from the beginning.	<ul style="list-style-type: none"> The air conditioner you are trying to register is already registered to another account. Registration failed because the air conditioner cannot connect to the Internet. Immediately after turning on the power of the air conditioner, wait for about 5 minutes before registering it. <p>Check the following contents and operate again.</p> <ol style="list-style-type: none"> Tap "Re-register" and conduct the registration processing again. Delete from another account or initialize the WLAN Adapter. Check that the wireless router is turned on. Check that wireless router is connected to the Internet. If not connected, reboot the wireless router. When rebooting does not solve the problem, contact the manufacturer of the wireless router. Check that the MAC address filter and privacy separator settings are not "enabled" on the wireless router.
2938	Registration failed because the air conditioner could not connect to the Internet. Perform the WPS connection procedure again and confirm that the WLAN lamp on the indoor unit or LED2 on the WLAN adapter is lit before registering. When problems are not resolved, there may be other causes. Tap the link below to check other solutions.	<ul style="list-style-type: none"> Registration failed because the air conditioner cannot connect to the Internet. Registration failed because the air conditioner is not connected to the same wireless router as the smartphone. <p>Check the following contents depending on the status of indoor unit wireless LAN indicator lamp or WLAN Adapter LED 2 and operate again.</p> <ul style="list-style-type: none"> When not lighting <ol style="list-style-type: none"> Check that the Electrical panel (Switch breaker) to the air conditioner is turned on. Check that the power plug of the air conditioner main unit is plugged in. Check that the wireless router is turned on. Retry the connection step procedure for the air conditioner registration displayed in the application and complete WPS connection with wireless router to set the lamp to the blinking state. When lighting <ol style="list-style-type: none"> Check that the air conditioner and the smartphone are connected to the same wireless router. Check that the local network setting of the smartphone is "Enabled". (Only for smartphones with iOS14 or later)
2942	Your mobile device is not connected to WiFi. Connect to the target wireless router through the OS WiFi setting and restart the procedure. <ol style="list-style-type: none"> Open the Wi-Fi setting screen of your device. Connect your mobile device to the {ssid}. Return to the application screen and tap "Re-register". <p>When problems are not resolved, there may be other causes. Tap the link below to check other solutions.</p>	<p>Registration failed because the air conditioner cannot connect to the Internet.</p> <p>Check the following contents and operate again.</p> <ol style="list-style-type: none"> Check that the wireless LAN setting of smartphone is set to ON. Check that the smartphone is connected to the Internet. Set the connection setting with the wireless router to Auto Connection in the smartphone settings. Check that the wireless router is turned on.

Error code	Error message	Cause
		Solution
2944	Communication failed.	Registration may have failed because a problem occurred in communication with the server (cloud). Wait for a while and then operate again.
2946	The connected air conditioner cannot use the Direct control.	Your air conditioner does not support Direct Control. Operate the air conditioner with Cloud Control.
2947	Already reached the max number of air conditioners per user.	The number of air conditioners that can be registered on AIRSTAGE Mobile has reached the maximum limit. Check the number of air conditioners registered on AIRSTAGE Mobile. (Maximum number of registered units: 50 units for Cloud Control, 50 units for Direct Control) Delete the unused air conditioners on the "Air conditioner editing" screen before registration.
2949	The number of air conditioners registered by the entered user has reached the upper limit, so registration is not possible.	The number of sub users that can be registered has reached the maximum limit. Check the number of registered sub users. (Maximum number of registered sub users: 4 sub users) Delete the unused sub users on the "Sub User Registration" screen.
2953	The specified air conditioner is already registered. To Reregister, delete the air conditioner information on the air conditioner edit screen and initialize the wireless LAN adapter with the remote control.	The specified air conditioner was already registered. Check that the specified air conditioner is displayed on the air conditioner list screen. To register again, delete the air conditioner on the air conditioner editing screen.
2954	The wireless router to which the mobile device and the wireless LAN adapter are connected must be the same. Follow the steps below. 1. Please open the Wi-Fi setting screen of the mobile device. 2. Connect your mobile device to the wireless router that you pressed the automatic connection button. 3. Return to the app screen and tap "OK".	The air conditioner and the smartphone are not connected to the same wireless router network. Check the following contents and operate again. 1. Check that the wireless LAN setting of smartphone is set to ON. 2. Check that the smartphone is connected to the Internet. 3. Check that the wireless router is turned on. 4. Check that the air conditioner and the smartphone are connected to the same wireless router.

• Sign in error

Error code	Error message	Cause
		Solution
4010 4410 4610 4810 4910	Communication failed. After checking the following contents, please try again after a while. • Ensure that your mobile device is connected to the internet.	Various settings could not be completed because communication with the server (cloud) failed.
		Check the following contents and operate again. 1. Check that the wireless LAN setting of smartphone is set to ON. 2. Check that the smartphone is connected to the Internet. 3. Check that the wireless router is turned on.
4100	The account you are currently signed in to may have been deleted. If necessary, please create the account again.	Token has been disabled because the signed-in account has been deleted or certain amount of time has elapsed.
		Restart the application and check that you can sign in. If you cannot sign in, create the account again.
4101	The session has expired. Please sign in again to continue.	Token has been disabled because the signed-in account has been deleted or certain amount of time has elapsed.
		Restart the application and check that you can sign in. If you cannot sign in, create the account again.
4102	Your session has expired. Please sign in again. *If you cannot sign in, your account may have been deleted. If necessary, please create an account again.	Token has been disabled because the signed-in account has been deleted or certain amount of time has elapsed.
		Restart the application and check that you can sign in. If you cannot sign in, create the account again.
4110	Failed to connect to the server. Some functions can be used with Direct Control. Do you want to switch to direct control?	• Communication with the server (cloud) failed at sign in. • Registration process of Account registration procedure verification email has not been completed.
		Check the following contents and sign in again. 1. Check that the wireless LAN setting of smartphone is set to ON. 2. Check that the smartphone is connected to the Internet. 3. Check that the wireless router is turned on. 4. Tap the link of Account registration procedure verification email and check that registration process has completed.
4111	Failed to read the device. Since some functions are available in Direct control, switch to Direct control.	Air conditioner information could not be obtained because communication with the server (cloud) failed after sign in.
		Check the following contents and sign in again. 1. Check that the wireless LAN setting of smartphone is set to ON. 2. Check that the smartphone is connected to the Internet. 3. Check that the wireless router is turned on.
4112	Failed to connect to the server. Some functions are limited.	• Communication with the server (cloud) failed at sign in. • Registration process of Account registration procedure verification email has not been completed.
		Check the following contents and sign in again. 1. Check that the wireless LAN setting of smartphone is set to ON. 2. Check that the smartphone is connected to the Internet. 3. Check that the wireless router is turned on. 4. Tap the link of Account registration procedure verification email and check that registration process has completed.
4113	Failed to connect to the server. Would you like to sign in again? Yes: Sign in again No: Return to the sign-in screen	Air conditioner information could not be obtained because communication with the server (cloud) failed after sign in.
		Check the following contents and sign in again. 1. Check that the wireless LAN setting of smartphone is set to ON. 2. Check that the smartphone is connected to the Internet. 3. Check that the wireless router is turned on.

Error code	Error message	Cause
		Solution
4420	Loading of user information failed. Check the following contents. <ul style="list-style-type: none"> Check that your mobile device is connected to the internet. 	User information or temperature unit information could not be obtained because communication with the server (cloud) failed.
		Check the following contents and operate again. <ol style="list-style-type: none"> Check that the wireless LAN setting of smartphone is set to ON. Check that the smartphone is connected to the Internet. Check that the wireless router is turned on.
4530	Password update failed. Please check if the entered current password is correct.	Password update failed because the entered password was not correct.
		Check that the entered "Current password" is correct and operate again.
4920	Loading of time zone failed. Check the following contents. <ul style="list-style-type: none"> Check that your mobile device is connected to the internet. 	Time zone information could not be obtained because communication with server (cloud) failed.
		Check the following contents and operate again. <ol style="list-style-type: none"> Check that the wireless LAN setting of smartphone is set to ON. Check that the smartphone is connected to the Internet. Check that the wireless router is turned on.

- General error

Error code	Error message	Cause
		Solution
0100 0200 0300 0400 0500 0501 0600 0601 0800 0900 1000 1200 1400 1500 3200 5500 5700 5900 6200	Communication failed. After checking the following contents, please try again after a while. <ul style="list-style-type: none"> • Ensure that the air conditioner is turned on. 	<p>Communication with the air conditioner failed.</p> <p>Check the following contents depending on the status of indoor unit wireless LAN indicator lamp or WLAN Adapter LED 2 and operate again.</p> <ul style="list-style-type: none"> • When not lighting <ul style="list-style-type: none"> – Check that the Electrical panel (Switch breaker) to the air conditioner is turned on. – Check that the power plug of the air conditioner main unit is plugged in. • When lighting <p>Use a smartphone to check that the wireless router to which the air conditioner is connected is connected to the Internet. If the smartphone cannot connect to the Internet, reboot the wireless router. When rebooting the wireless router does not solve the problem, contact the manufacturer of the wireless router.</p>
0810 0811 0812 1510 1511 1512 3010 5510 5520 5530 6001 6002 6003 6010 6011 6012 6013 6310	Communication failed. After checking the following contents, please try again after a while. <ul style="list-style-type: none"> • Ensure that your mobile device is connected to the internet. 	<ul style="list-style-type: none"> • Various settings could not be completed because communication with the server (cloud) failed. • Air conditioner information could not be obtained because communication with server (cloud) failed. <p>Check the following contents and operate again.</p> <ol style="list-style-type: none"> 1. Check that the wireless LAN setting of smartphone is set to ON. 2. Check that the smartphone is connected to the Internet. 3. Check that the wireless router is turned on.

Error code	Error message	Cause
		Solution
0820	<p>Loading of outdoor low noise timer failed. Check the following contents.</p> <ul style="list-style-type: none"> Ensure that your mobile device is connected to the internet. 	<p>The outdoor unit low noise timer information could not be obtained because communication with the server (cloud) failed.</p> <p>Check the following contents depending on the status of indoor unit wireless LAN indicator lamp or WLAN Adapter LED 2 and operate again.</p> <ul style="list-style-type: none"> When not lighting <ul style="list-style-type: none"> Check that the Electrical panel (Switch breaker) to the air conditioner is turned on. Check that the power plug of the air conditioner main unit is plugged in. When lighting <p>Use a smartphone to check that the wireless router to which the air conditioner is connected is connected to the Internet. If the smartphone cannot connect to the Internet, reboot the wireless router. When rebooting the wireless router does not solve the problem, contact the manufacturer of the wireless router.</p> When blinking <p>Wait for a while until the indicator lamp lights and then operate again. If the indicator lamp is still blinking after waiting for a while, check that the wireless router is turned on.</p>
1520	<p>Loading of weekly timer failed. Check the following contents.</p> <ul style="list-style-type: none"> Ensure that your mobile device is connected to the internet. 	<p>The weekly timer setting information could not be obtained because communication with the server (cloud) failed.</p> <p>Check the following contents depending on the status of indoor unit wireless LAN indicator lamp or WLAN Adapter LED 2 and operate again.</p> <ul style="list-style-type: none"> When not lighting <ul style="list-style-type: none"> Check that the Electrical panel (Switch breaker) to the air conditioner is turned on. Check that the power plug of the air conditioner main unit is plugged in. When lighting <p>Use a smartphone to check that the wireless router to which the air conditioner is connected is connected to the Internet. If the smartphone cannot connect to the Internet, reboot the wireless router. When rebooting the wireless router does not solve the problem, contact the manufacturer of the wireless router.</p> When blinking <p>Wait for a while until the lamp lights and then operate again. If the lamp is still blinking after waiting for a while, check that the wireless router is turned on.</p>

Error code	Error message	Cause
		Solution
1720	<p>Loading of error history failed. Check the following contents.</p> <ul style="list-style-type: none"> Ensure that your mobile device is connected to the internet. 	<p>The error history information could not be obtained because communication with the server (cloud) failed.</p> <p>Check the following contents depending on the status of indoor unit wireless LAN indicator lamp or WLAN Adapter LED 2 and operate again.</p> <ul style="list-style-type: none"> When not lighting <ul style="list-style-type: none"> Check that the Electrical panel (Switch breaker) to the air conditioner is turned on. Or check that the power plug of the air conditioner main unit is plugged in. When lighting <p>Use a smartphone to check that the wireless router to which the air conditioner is connected is connected to the Internet. If the smartphone cannot connect to the Internet, reboot the wireless router. When rebooting the wireless router does not solve the problem, contact the manufacturer of the wireless router.</p> When blinking <p>Wait for a while until the indicator lamp lights and then operate again. If the indicator lamp is still blinking after waiting for a while, check that the wireless router is turned on.</p>
		<p>Air conditioner group setting has not been completed because communication with air conditioner failed.</p> <p>Check the following contents depending on the status of indoor unit wireless LAN indicator lamp or WLAN Adapter LED 2 and operate again.</p> <ul style="list-style-type: none"> When not lighting <ul style="list-style-type: none"> Check that the Electrical panel (Switch breaker) to the air conditioner is turned on. Check that the power plug of the air conditioner main unit is plugged in. When lighting <p>Use a smartphone to check that the wireless router to which the air conditioner is connected is connected to the Internet. If the smartphone cannot connect to the Internet, reboot the wireless router. When rebooting the wireless router does not solve the problem, contact the manufacturer of the wireless router.</p> When blinking <p>Wait for a while until the indicator lamp lights and then operate again. If the indicator lamp is still blinking after waiting for a while, check that the wireless router is turned on.</p>
3110	<p>Communication failure prevented the group movement processing from being conducted. After checking the following contents, please try again after a while.</p> <ul style="list-style-type: none"> Ensure that your mobile device is connected to the internet. 	<p>Air conditioner group setting has not been completed because communication with air conditioner failed.</p> <p>Check the following contents depending on the status of indoor unit wireless LAN indicator lamp or WLAN Adapter LED 2 and operate again.</p> <ul style="list-style-type: none"> When not lighting <ul style="list-style-type: none"> Check that the Electrical panel (Switch breaker) to the air conditioner is turned on. Check that the power plug of the air conditioner main unit is plugged in. When lighting <p>Use a smartphone to check that the wireless router to which the air conditioner is connected is connected to the Internet. If the smartphone cannot connect to the Internet, reboot the wireless router. When rebooting the wireless router does not solve the problem, contact the manufacturer of the wireless router.</p> When blinking <p>Wait for a while until the indicator lamp lights and then operate again. If the indicator lamp is still blinking after waiting for a while, check that the wireless router is turned on.</p>

Error code	Error message	Cause
		Solution
3111	<p>Communication failure prevented the group creation processing from being conducted. After checking the following contents, please try again after a while.</p> <ul style="list-style-type: none"> Ensure that your mobile device is connected to the internet. 	<p>Air conditioner group setting has not been completed because communication with air conditioner failed.</p> <p>Check the following contents depending on the status of indoor unit wireless LAN indicator lamp or WLAN Adapter LED 2 and operate again.</p> <ul style="list-style-type: none"> When not lighting <ul style="list-style-type: none"> Check that the Electrical panel (Switch breaker) to the air conditioner is turned on. Check that the power plug of the air conditioner main unit is plugged in. When lighting <p>Use a smartphone to check that the wireless router to which the air conditioner is connected is connected to the Internet. If the smartphone cannot connect to the Internet, reboot the wireless router. When rebooting the wireless router does not solve the problem, contact the manufacturer of the wireless router.</p> When blinking <p>Wait for a while until the indicator lamp lights and then operate again. If the indicator lamp is still blinking after waiting for a while, check that the wireless router is turned on.</p>
		<p>Air conditioner group setting has not been completed because communication with air conditioner failed.</p> <p>Check the following contents depending on the status of indoor unit wireless LAN indicator lamp or WLAN Adapter LED 2 and operate again.</p> <ul style="list-style-type: none"> When not lighting <ul style="list-style-type: none"> Check that the Electrical panel (Switch breaker) to the air conditioner is turned on. Check that the power plug of the air conditioner main unit is plugged in. When lighting <p>Use a smartphone to check that the wireless router to which the air conditioner is connected is connected to the Internet. If the smartphone cannot connect to the Internet, reboot the wireless router. When rebooting the wireless router does not solve the problem, contact the manufacturer of the wireless router.</p> When blinking <p>Wait for a while until the indicator lamp lights and then operate again. If the indicator lamp is still blinking after waiting for a while, check that the wireless router is turned on.</p>
3112	<p>Communication failure prevented the group name change processing from being conducted. After checking the following contents, please try again after a while.</p> <ul style="list-style-type: none"> Ensure that your mobile device is connected to the internet. 	<p>Air conditioner group setting has not been completed because communication with air conditioner failed.</p> <p>Check the following contents depending on the status of indoor unit wireless LAN indicator lamp or WLAN Adapter LED 2 and operate again.</p> <ul style="list-style-type: none"> When not lighting <ul style="list-style-type: none"> Check that the Electrical panel (Switch breaker) to the air conditioner is turned on. Check that the power plug of the air conditioner main unit is plugged in. When lighting <p>Use a smartphone to check that the wireless router to which the air conditioner is connected is connected to the Internet. If the smartphone cannot connect to the Internet, reboot the wireless router. When rebooting the wireless router does not solve the problem, contact the manufacturer of the wireless router.</p> When blinking <p>Wait for a while until the indicator lamp lights and then operate again. If the indicator lamp is still blinking after waiting for a while, check that the wireless router is turned on.</p>
		<p>Air conditioner group setting has not been completed because communication with air conditioner failed.</p> <p>Check the following contents depending on the status of indoor unit wireless LAN indicator lamp or WLAN Adapter LED 2 and operate again.</p> <ul style="list-style-type: none"> When not lighting <ul style="list-style-type: none"> Check that the Electrical panel (Switch breaker) to the air conditioner is turned on. Check that the power plug of the air conditioner main unit is plugged in. When lighting <p>Use a smartphone to check that the wireless router to which the air conditioner is connected is connected to the Internet. If the smartphone cannot connect to the Internet, reboot the wireless router. When rebooting the wireless router does not solve the problem, contact the manufacturer of the wireless router.</p> When blinking <p>Wait for a while until the indicator lamp lights and then operate again. If the indicator lamp is still blinking after waiting for a while, check that the wireless router is turned on.</p>

Error code	Error message	Cause
		Solution
3113	<p>Communication failure prevented the group deletion processing from being conducted. After checking the following contents, please try again after a while.</p> <ul style="list-style-type: none"> Ensure that your mobile device is connected to the internet. 	<p>Air conditioner group setting has not been completed because communication with air conditioner failed.</p> <p>Check the following contents depending on the status of indoor unit wireless LAN indicator lamp or WLAN Adapter LED 2 and operate again.</p> <ul style="list-style-type: none"> When not lighting <ul style="list-style-type: none"> Check that the Electrical panel (Switch breaker) to the air conditioner is turned on. Check that the power plug of the air conditioner main unit is plugged in. When lighting <p>Use a smartphone to check that the wireless router to which the air conditioner is connected is connected to the Internet. If the smartphone cannot connect to the Internet, reboot the wireless router. When rebooting the wireless router does not solve the problem, contact the manufacturer of the wireless router.</p> When blinking <p>Wait for a while until the indicator lamp lights and then operate again. If the indicator lamp is still blinking after waiting for a while, check that the wireless router is turned on.</p>
		<p>Air conditioner group setting has not been completed because communication with air conditioner failed.</p> <p>Check the following contents depending on the status of indoor unit wireless LAN indicator lamp or WLAN Adapter LED 2 and operate again.</p> <ul style="list-style-type: none"> When not lighting <ul style="list-style-type: none"> Check that the Electrical panel (Switch breaker) to the air conditioner is turned on. Check that the power plug of the air conditioner main unit is plugged in. When lighting <p>Use a smartphone to check that the wireless router to which the air conditioner is connected is connected to the Internet. If the smartphone cannot connect to the Internet, reboot the wireless router. When rebooting the wireless router does not solve the problem, contact the manufacturer of the wireless router.</p> When blinking <p>Wait for a while until the indicator lamp lights and then operate again. If the indicator lamp is still blinking after waiting for a while, check that the wireless router is turned on.</p>
3114	<p>The room temperature display indoor unit setting could not be made due to a communication failure. After checking the following contents, please try again after a while.</p> <ul style="list-style-type: none"> Ensure that your mobile device is connected to the internet. 	<p>Air conditioner group setting has not been completed because communication with air conditioner failed.</p> <p>Check the following contents depending on the status of indoor unit wireless LAN indicator lamp or WLAN Adapter LED 2 and operate again.</p> <ul style="list-style-type: none"> When not lighting <ul style="list-style-type: none"> Check that the Electrical panel (Switch breaker) to the air conditioner is turned on. Check that the power plug of the air conditioner main unit is plugged in. When lighting <p>Use a smartphone to check that the wireless router to which the air conditioner is connected is connected to the Internet. If the smartphone cannot connect to the Internet, reboot the wireless router. When rebooting the wireless router does not solve the problem, contact the manufacturer of the wireless router.</p> When blinking <p>Wait for a while until the indicator lamp lights and then operate again. If the indicator lamp is still blinking after waiting for a while, check that the wireless router is turned on.</p>
		<p>Air conditioner group setting has not been completed because communication with air conditioner failed.</p> <p>Check the following contents depending on the status of indoor unit wireless LAN indicator lamp or WLAN Adapter LED 2 and operate again.</p> <ul style="list-style-type: none"> When not lighting <ul style="list-style-type: none"> Check that the Electrical panel (Switch breaker) to the air conditioner is turned on. Check that the power plug of the air conditioner main unit is plugged in. When lighting <p>Use a smartphone to check that the wireless router to which the air conditioner is connected is connected to the Internet. If the smartphone cannot connect to the Internet, reboot the wireless router. When rebooting the wireless router does not solve the problem, contact the manufacturer of the wireless router.</p> When blinking <p>Wait for a while until the indicator lamp lights and then operate again. If the indicator lamp is still blinking after waiting for a while, check that the wireless router is turned on.</p>

Error code	Error message	Cause
		Solution
3115	Some device group move processing could not be conducted due to communication failure. After checking the following contents, please try again after a while. <ul style="list-style-type: none"> Ensure that your mobile device is connected to the internet. 	Air conditioner group setting has not been completed because communication with air conditioner failed.
		Check the following contents depending on the status of indoor unit wireless LAN indicator lamp or WLAN Adapter LED 2 and operate again. <ul style="list-style-type: none"> When not lighting <ul style="list-style-type: none"> Check that the Electrical panel (Switch breaker) to the air conditioner is turned on. Check that the power plug of the air conditioner main unit is plugged in. When lighting <p>Use a smartphone to check that the wireless router to which the air conditioner is connected is connected to the Internet. If the smartphone cannot connect to the Internet, reboot the wireless router. When rebooting the wireless router does not solve the problem, contact the manufacturer of the wireless router.</p> When blinking <p>Wait for a while until the indicator lamp lights and then operate again. If the indicator lamp is still blinking after waiting for a while, check that the wireless router is turned on.</p>
5320	Loading of air conditioner information failed. Check the following contents. <ul style="list-style-type: none"> Ensure that your mobile device is connected to the internet. 	Air conditioner information could not be obtained because communication with server (cloud) failed.
		<ol style="list-style-type: none"> Check that the wireless LAN setting of smartphone is set to ON. Check that the smartphone is connected to the Internet. Check that the wireless router is turned on.
5531 5540	New firmware update failed.	Firmware update failed.
		Check the following contents and operate again. <ol style="list-style-type: none"> Check that the wireless LAN setting of smartphone is set to ON. Check that the smartphone is connected to the Internet. Check that the wireless router is turned on. Refer to the operation manual of air conditioner and check the indicator lamp state of air conditioner indoor unit.
5601	Failed to get the air conditioner information.	Failed to obtain air conditioner information by Direct Control.
		Sign in again.
5602	Failed to add the air conditioner.	Failed to add air conditioner by Direct Control.
		Check the following contents and operate again. <ol style="list-style-type: none"> When 2D barcode label is used, scan 2D barcode label again. When 2D barcode label is not used, check that the entered SSID or PIN code is correct.
5630	Device disconnection failed. After checking the following contents, please try again after a while. <ul style="list-style-type: none"> Ensure that your mobile device is connected to the internet. 	Failed to disconnect the connection with air conditioner by Direct Control.
		Check the following contents and operate again. <ol style="list-style-type: none"> Check that the smartphone is connected with the air conditioner. Check that the Electrical panel (Switch breaker) to the air conditioner is turned on. Check that the power plug of the air conditioner main unit is plugged in.

Error code	Error message	Cause
		Solution
6201	Failed to update the screen. After checking the following contents, please try again after a while. <ul style="list-style-type: none"> Ensure that your mobile device is connected to the internet. 	Various settings could not be completed because communication with the server (cloud) failed.
		Check the following contents and operate again. <ol style="list-style-type: none"> Check that the wireless LAN setting of smartphone is set to ON. Check that the smartphone is connected to the Internet. Check that the wireless router is turned on.
7610	Communication failed. Check the following contents. <ul style="list-style-type: none"> Ensure that your mobile device is connected to the internet. 	Various settings could not be completed because communication with the server (cloud) failed.
		Check the following contents and operate again. <ol style="list-style-type: none"> Check that the wireless LAN setting of smartphone is set to ON. Check that the smartphone is connected to the Internet. Check that the wireless router is turned on.

2. Troubleshooting with error code

2-1. E: 11. Serial communication error (Serial reverse transfer error) (Outdoor unit)

Indicator	Indoor unit	Operation indicator	1 time flash
		Timer indicator	1 time flash
		Economy indicator	Continuous flash
		Error code	E: 11
Detective actuator	Outdoor unit	Main PCB	When the indoor unit cannot receive the serial signal from outdoor unit more than 2 minutes after power on, or the indoor unit cannot receive the serial signal more than 15 seconds during normal operation.
		Fan motor	
Forecast of cause		Connection failure	
		External cause	
		Main PCB failure	
		Outdoor unit fan motor failure	

Check point 1. Reset the power and operate

Does error indication show again?

→ If no, go to "Check point 1-2".



Check point 2. Check connection

Check any loose or removed connection line of indoor unit and outdoor unit.

Check connection condition is control unit. (If there is loose connector, open cable or mis-wiring.)

→ If there is an abnormal condition, correct it by referring to the installation manual or the "DESIGN & TECHNICAL MANUAL".



Check point 3. Check the voltage of power supply

Check the voltage of power supply

Check if AC 207 V (AC 230 V -10%) to AC 253 V (AC 230 V +10%) appears at outdoor unit terminal L—N.



Check point 4. Check serial signal (Reverse transfer signal)

Check serial signal (Reverse transfer signal)

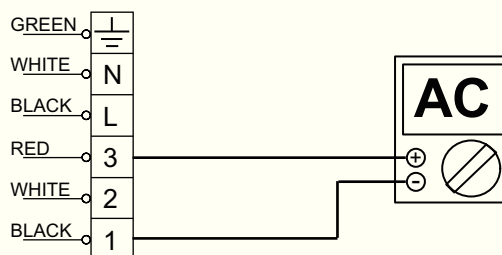

- Check if indicated value swings between AC 90 V and AC 270 V at the outdoor unit terminal 1—3.
- If it is abnormal, check the parts below.
 - Outdoor unit fan motor
- If outdoor fan motor is abnormal, replace outdoor unit fan motor and main PCB.
- If the checked parts are normal, replace the main PCB.



End

Check point 1-2. Check external cause such as noise

- Check the complete insulation of the grounding.
- Check if there is any equipment that causes harmonic wave near the power cable (Neon light bulb or any electronic equipment which causes harmonic wave).



End

2-2. E: 11. Serial communication error (Serial forward transfer error) (Indoor unit)

Indicator	Indoor unit	Operation indicator	1 time flash
		Timer indicator	1 time flash
		Economy indicator	Continuous flash
		Error code	E: 11
Detective actuator	Indoor unit	Main PCB	When the outdoor unit cannot receive the serial signal from indoor unit more than 10seconds.
		Fan motor	
Forecast of cause		Connection failure	
		External cause	
		Main PCB failure	
		Indoor unit fan motor failure	

Check point 1. Reset the power and operate

Does error indication show again?
→ If no, go to "Check point 1-2".



Check point 2. Check connection

Check any loose or removed connection line of indoor unit and outdoor unit.
Check connection condition is control unit. (If there is loose connector, open cable or mis-wiring.)
→ If there is an abnormal condition, correct it by referring to the installation manual or the *DESIGN & TECHNICAL MANUAL*.



Check point 3. Check the voltage of power supply

Check the voltage of power supply
Check if AC 207 V (AC 230 V -10%) to AC 253 V (AC 230 V +10%) appears at outdoor unit terminal L—N.



Check point 4. Check serial signal (reverse transfer signal)

Check serial signal (Forward transfer signal)

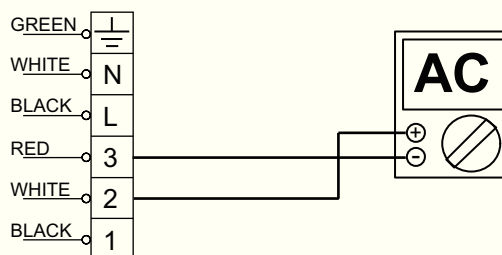

- Check if indicated value swings between AC 30 V and AC 130 V at outdoor unit terminal 2—3.
- If it is abnormal, replace main PCB.
- If it is abnormal, check indoor unit fan motor. (Indoor unit fan motor in "[Service parts information](#)" on page 03-74)
- If indoor unit fan motor is abnormal, replace indoor unit fan motor and main PCB.



End

Check point 1-2. Check external cause such as noise

- Check the complete insulation of the grounding.
- Check if there is any equipment that causes harmonic wave near the power cable (Neon light bulb or any electronic equipment which causes harmonic wave).



End

2-3. E: 12. Wired remote controller communication error (Indoor unit)

Indicator	Indoor unit	Operation indicator	1 time flash
		Timer indicator	2 time flash
		Economy indicator	Continuous flash
		Error code	E: 12
Detective actuator	Indoor unit	Main PCB	When the indoor unit cannot receive the signal from Wired remote controller more than 1 minute during normal operation.
	Wired remote control		
Forecast of cause			Connection failure
			Wired remote control failure
			Main PCB failure
			Communication kit

Check point 1. Check the connection of terminal

After turning off the power, check & correct the followings.

- Check the connection of terminal between remote controller and indoor unit, and check if there is a disconnection of the cable.



Check point 2. Check connection

Check voltage at CN300 (terminal 1—3) of Communication Kit. (Power supply to the remote controller)

Upon correcting the removed connector or mis-wiring, reset the power.



- If it is DC 12 V, remote controller is failure. (Main PCB is normal)
 - Replace Remote Control
- If it is DC 0 V, main PCB is failure. (Check remote controller once again)
 - Replace main PCB



End

2-4. E: 18. External communication error (Indoor unit)

Indicator	Indoor unit	Operation indicator	1 time flash
		Timer indicator	8 time flash
		Economy indicator	Continuous flash
		Error code	E: 18
Detective actuator	Indoor unit	External communication error	After receiving a signal from the external input and output PCB, the same signal has not been received for 15 seconds.
Forecast of cause			Connection failure
			WLAN Adapter failure
			Main PCB

Check point 1. Check the connection

- Check any loose or removed connection between the main PCB to the WLAN Adapter.
-> If there is an abnormal condition, correct it by refer to the installation manual or the "DESIGN & TECHNICAL MANUAL".
- Check the connection condition on the WLAN Adapter and the main PCB (If there is loose connector, open cable or mis-wiring.)



Check point 2. Replace the WLAN Adapter

If check point 1 do not improve the symptom, change WLAN Adapter.



Check point 3. Replace the main PCB

If check point 2 do not improve the symptom, replace the main PCB.



End

2-5. E: 22. Indoor unit capacity error (Indoor unit)

Indicator	Indoor unit	Operation indicator	2 time flash
		Timer indicator	2 time flash
		Economy indicator	Continuous flash
		Error code	E: 22
Detective actuator	Indoor unit main PCB	When the total capacity of the indoor units does not match outdoor unit capacity while 3 minutes after power on.	
Forecast of cause		Indoor unit selection is incorrect.	
		Main PCB failure	

Check point 1. Check the total capacity of indoor units

Check the total capacity of the indoor units.

→ If abnormal condition is found, correct it referring to the installation manual or DESIGN & TECHNICAL MANUAL.



Check point 2. Replace the main PCB

If check point 1 does not improve the symptom, replace the main PCB.



End

2-6. E: 23. Combination error (Outdoor unit)

Indicator	Indoor unit	Operation indicator	2 time flash
		Timer indicator	3 time flash
		Economy indicator	Continuous flash
		Error code	E: 23
Detective actuator	Indoor unit	The outdoor unit receives the serial signal of applied refrigerant information from indoor unit.	
Forecast of cause		Incorrect indoor unit is selected.	

Check point 1. Check the type of indoor unit

- Check the type of the connected indoor unit.
-> If there is an abnormal condition, correct it by refer to the installation manual or the "DESIGN & TECHNICAL MANAL".



Check point 2. Replace the main PCB

If check point 1 do not improve the symptom, replace the main PCB of the outdoor unit.



End

2-7. E: 26. Address setting error in wired remote controller (Indoor unit)

Indicator	Indoor unit	Operation indicator	2 time flash
		Timer indicator	6 time flash
		Economy indicator	Continuous flash
		Error code	E: 26
Detective actuator	Wired remote controller (2-wire)	<ul style="list-style-type: none"> When the address number set by auto setting and manual setting are mixed in one remote controller group 	
	Indoor unit controller PCB	<ul style="list-style-type: none"> When the duplicated address number exists in one remote controller group 	
Forecast of cause		Wrong wiring of remote controller group	
		Wrong remote controller address setting	
		Indoor unit main PCB failure	
		Remote controller failure	

Check point 1. Wire installation

- Check the wire connection in the remote controller group (For installation method, refer to installation manual)
-> If there is an abnormal condition, correct it by refer to the installation manual or the "DESIGN & TECHNICAL MANUAL".



Check point 2. Wrong remote controller group setting

- The given address number by auto setting (00) and the manual set number (except 00) are not existing in one remote controller group.
- The remote controller address setting by UI is not existing same address.
- The duplicate address number is not existing in one remote controller group.



Check point 3. Check indoor unit main PCB

- Check if main PCB is damaged.
- Change main PCB and check the error after setting remote controller address.



End

2-8. E: 29. Connected unit number error (Indoor unit)

Indicator	Indoor unit	Operation indicator	2 time flash
		Timer indicator	9 time flash
		Economy indicator	Continuous flash
		Error code	E: 29
Detective actuator	Wired remote controller (2-wire)	When the number of the connected indoor unit exceeds the limitation.	
	Indoor unit main PCB		
Forecast of cause		Wrong wiring of indoor unit or remote controller	
		Number of indoor unit or remote controller in remote controller group	
		Indoor unit main PCB failure	

Check point 1. Wire installation

- Wrong number of connected indoor unit
-> If there is an abnormal condition, correct it by refer to the installation manual or the "DESIGN & TECHNICAL MANUAL".



Check point 2. Check indoor unit main PCB

- Check if main PCB is damaged.
- Change main PCB and check the error after setting remote controller address.



End

2-9. E: 32. Indoor unit main PCB error (Indoor unit)

Indicator	Indoor unit	Operation indicator	3 time flash
		Timer indicator	2 time flash
		Economy indicator	Continuous flash
		Error code	E: 32
Detective actuator	Indoor unit	Main PCB	When power is on and there is some below case. 1. When model information of EEPROM is incorrect. 2. When the access to EEPROM failed.
Forecast of cause			External cause
			Defective connection of electrical components
			Main PCB failure

Check point 1. Reset power supply and operate

Does error indication show again?

→ If no, go to "Check point 1-2".



Check point 2. Check Indoor unit electrical components

- Check all connectors. (loose connector or incorrect wiring)
- Check any shortage or corrosion on PCB.



Check point 3. Replace the main PCB

Replace the main PCB.



End

Check point 1-2. Check external cause such as noise

- Check if the ground connection is proper.
- Check if there is any equipment that causes harmonic wave near the power cable (Neon light bulb or any electronic equipment which causes harmonic wave).



End

NOTE: EEPROM

EEPROM (Electrically Erasable and Programmable Read Only Memory) is a non-volatile memory which keeps memorized information even if the power is turned off. It can change the contents electronically. To change the contents, it uses higher voltage than normal, and it cannot change a partial contents. (Rewriting shall be done upon erasing the all contents.) There is a limit in a number of rewriting.

2-10. E: 33. Indoor unit motor electricity consumption detection error (Indoor unit)

Indicator	Indoor unit	Operation indicator	3 time flash
		Timer indicator	3 time flash
		Economy indicator	Continuous flash
		Error code	E: 33
Detective actuator	Indoor unit motor electricity consumption detection		When the voltage value or the current value of the motor go beyond the limits
Forecast of cause			Fan motor failure
			Main PCB failure

Check point 1. Check the rotation of fan

Rotate the fan by hand when the operation is off. (Check if fan is caught, drop off or locked motor)
→ If fan or bearing is abnormal, replace it.



Check point 2. Check ambient temperature around the motor

Check excessively high temperature around the motor. (If there is any surrounding equipment that causes heat.)
→ Upon the temperature coming down, restart operation.



Check point 3. Check indoor unit fan motor

Check indoor unit fan motor. (Refer to indoor unit fan motor in "[Service parts information](#)" on page 03-74.)
→ If indoor unit fan motor is abnormal, replace it.



Check point 4. Replace the main PCB

If check point 1-3 does not improve the symptom, replace the main PCB.



End

2-11. E: 35. MANUAL AUTO button error (Indoor unit)

Indicator	Indoor unit	Operation indicator	3 time flash
		Timer indicator	5 time flash
		Economy indicator	Continuous flash
		Error code	E: 35
Detective actuator	Indoor unit controller PCB	When the MANUAL AUTO button becomes on for consecutive 60 or more seconds.	
	Indicator PCB		
	Manual auto switch		
Forecast of cause		MANUAL AUTO button failure	
		Controller PCB and indicator PCB failure	

Check point 1. Check the MANUAL AUTO button

- Check if MANUAL AUTO button is kept pressed.
- Check ON/OFF switching operation by using a meter.



If MANUAL AUTO button is disabled (ON/OFF switching), replace it.



Check point 2. Replace the main PCB and indicator PCB

If Check Point 1 does not improve the symptom, replace the main PCB and indicator PCB.



End

2-12. E: 39. Indoor unit power supply error for fan motor (Indoor unit)

Indicator	Indoor unit	Operation indicator	3 time flash
		Timer indicator	9 time flash
		Economy indicator	Continuous flash
		Error code	E: 39
Detective actuator	Indoor unit main PCB	<ul style="list-style-type: none"> When a momentary power cut off When do not start fan motor 	
Forecast of cause		External cause	
		Connector connection failure	
		Main PCB failure	

Check point 1. Check external cause at indoor and outdoor (Voltage drop or Noise)

- Instant drop: Check if there is a large load electric apparatus in the same circuit.
- Momentary power failure: Check if there is a defective contact or leak current in the power supply circuit.
- Noise: Check if there is any equipment causing harmonic wave near electric line. (Neon bulb or electric equipment that may cause harmonic wave)
Check the complete insulation of grounding.



Check point 2. Check connection of Connector

- Check if connector is removed.
- Check erroneous connection.
- Check if cable is open.

→ Upon correcting the removed connector or mis-wiring, reset the power.



Check point 3. Replace the main PCB

If check point 1 to 2 do not improve the symptom, replace the main PCB.



End

2-13. E: 3A. Indoor unit communication circuit (wired remote controller) error

Indicator	Indoor unit	Operation indicator	3 time flash
		Timer indicator	10 time flash
		Economy indicator	Continuous flash
		Error code	E: 3A
Detective actuator	Wired remote controller (2-wire)	Detect the communication error of microcomputer and communication PCB.	
	Indoor unit controller PCB circuit		
Forecast of cause		Communication PCB defective	
		Indoor unit main PCB defective	

Check point 1. Check the connection of terminal

- After turning off the power supply, check and correct the followings
Indoor unit - Check the connection the communication PCB and the main PCB



Check Point 2 : Replace the communication PCB

If the Check point 1 is ok, replace the communication PCB



Check Point 3 : Replace the main PCB

If condition is doesn't change, replace the main PCB



End

2-14. E: 41. Room temperature sensor error (Indoor unit)

Indicator	Indoor unit	Operation indicator	4 time flash
		Timer indicator	1 time flash
		Economy indicator	Continuous flash
		Error code	E: 41
Detective actuator	Indoor unit main PCB	Room temperature thermistor is open or short is detected always.	
	Room temperature thermistor		
Forecast of cause		Connector failure	
		Thermistor failure	
		Main PCB failure	

Check point 1. Check connection of connector

- Check if connector is loose or removed.
- Check erroneous connection.
- Check if thermistor cable is open

-> Reset power when reinstalling due to removed connector or incorrect wiring.



Check point 2. Remove connector and check thermistor resistance value

- For the room thermistor resistance value, refer to "[Thermistor resistance values](#)" on page 03-82.
- If thermistor is either open or shorted, replace it and reset the power.

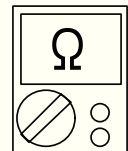

Check point 3. Check voltage of main PCB

Make sure circuit diagram of each indoor unit and check terminal voltage at thermistor (DC 5.0 V).

NOTE: For details of thermistor connector, refer to "[Wiring diagrams](#)" in Chapter 2. TECHNICAL DATA AND PARTS LIST on page 02-14.

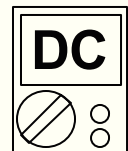

If the voltage does not appear, replace main PCB.



End

2-15. E: 42. Indoor unit heat exchanger sensor error (Indoor unit)

Indicator	Indoor unit	Operation indicator	4 time flash
		Timer indicator	2 time flash
		Economy indicator	Continuous flash
		Error code	E: 42
Detective actuator	Indoor unit main PCB	When heat exchanger temperature thermistor open or short circuit is detected.	
	Heat exchanger temperature thermistor		
Forecast of cause			Connector connection failure
			Thermistor failure
			Main PCB failure

Check point 1. Check connection of connector

- Check if connector is loose or removed.
- Check erroneous connection.
- Check if thermistor cable is open

-> Reset power when reinstalling due to removed connector or incorrect wiring.



Check point 2. Remove connector and check thermistor resistance value

- For the heat exchanger thermistor resistance value, refer to "[Thermistor resistance values](#)" on page 03-82.
- If thermistor is either open or shorted, replace it and reset the power.

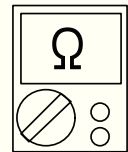

Check point 3. Check voltage of main PCB

Make sure circuit diagram of each indoor unit and check terminal voltage at thermistor (DC 5.0 V).

NOTE: For details of thermistor connector, refer to "[Wiring diagrams](#)" in Chapter 2. TECHNICAL DATA AND PARTS LIST on page 02-14.

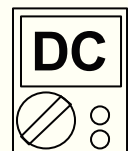

If the voltage does not appear, replace main PCB.



End

2-16. E: 44. Human sensor error

Indicator	Indoor unit	Operation indicator	4 time flash
		Timer indicator	4 time flash
		Economy indicator	Continuous flash
		Error code	E: 44
Detective actuator	Indoor unit main PCB	<ol style="list-style-type: none"> 1. Detect the open condition of the sensor. 2. When signal from sensor is "L" (0 V) for more than 20 min. 	
Forecast of cause		Connector connection failure	
		Sensor failure	
		Main PCB failure	

Check point 1. Check the connector connection and cable open

- Check if connector is loose or removed.
- Check erroneous connection.
- Check if sensor cable is open
→ Reset power when reinstalling due to removed connector or incorrect wiring.



Check point 2. Check the conduction or voltage

- **Conduction check (sensor connections error)**
Disconnect the sensor and check the 2-3 pin on sensor connector.
→ With conduction: Sensor failure
→ Without conduction: Main PCB failure
- **Voltage check (sensor signal error)**
Disconnect the sensor and check the voltage of 3 pin of the CN10 on the main PCB.
→ 5 V: Sensor failure
→ Other than 5 V: Main PCB failure



End

2-17. E: 51. Indoor unit fan motor error (Indoor unit)

Indicator	Indoor unit	Operation indicator	5 time flash
		Timer indicator	1 time flash
		Economy indicator	Continuous flash
		Error code	E: 51
Detective actuator	Indoor unit	Main PCB	When the actual rotation number of the indoor unit fan motor is below 1/3 of the target rotation number continuously for more than 56 seconds.
		Fan motor	
Forecast of cause		Fan rotation failure	
		Fan motor winding open	
		Motor protection by surrounding temperature rise	
		Control PCB failure	
		Indoor unit fan motor failure	

Check point 1. Check rotation of fan

Rotate the fan by hand when operation is off. (Check if fan is caught, dropped off or locked motor)
→ If fan or bearing is abnormal, replace it.



Check point 2. Check ambient temperature around motor

Check excessively high temperature around the motor. (If there is any surrounding equipment that causes heat)
→ Upon the temperature coming down, restart operation.



Check point 3. Check indoor unit fan motor

Check Indoor unit fan motor. (Refer to indoor unit fan motor in "[Service parts information](#)" on page 03-74.)
→ If Indoor unit fan motor is abnormal, replace Indoor unit fan motor.



Check point 4. Replace the main PCB

If Check Point 1 to 3 do not improve the symptom, replace the main PCB.



End

2-18. E: 5U. Indoor unit error

Indicator	Indoor unit	Operation indicator	5 time flash
		Timer indicator	15 time flash
		Economy indicator	Continuous flash
		Error code	E: 5U

Check point. Check following error code.

E: 11. Serial communication error (Serial reverse transfer error) (Outdoor unit)

E: 11. Serial communication error (Serial forward transfer error) (Indoor unit)

E: 18. External communication error (Indoor unit)

E: 22. Indoor unit capacity error (Indoor unit)

E: 23. Combination error (Outdoor unit)

E: 26. Address setting error in wired remote controller (Indoor unit)

E: 29. Connected unit number error (Indoor unit)

E: 32. Indoor unit main PCB error (Indoor unit)

E: 33. Indoor unit motor electricity consumption detection error (Indoor unit)

E: 35. MANUAL AUTO button error (Indoor unit)

E: 39. Indoor unit power supply error for fan motor (Indoor unit)

E: 3A. Indoor unit communication circuit (wired remote controller) error

E: 41. Room temperature sensor error (Indoor unit)

E: 42. Indoor unit heat exchanger sensor error (Indoor unit)

E: 44. Human sensor error

E: 51. Indoor unit fan motor error (Indoor unit)



End

2-19. E: 62. Outdoor unit main PCB error (Outdoor unit)

Indicator	Indoor unit	Operation indicator	6 time flash
		Timer indicator	2 time flash
		Economy indicator	Continuous flash
		Error code	E: 62
Detective actuator	Outdoor unit	Main PCB	Access to EEPROM failed due to some cause after outdoor unit started.
Forecast of cause			External cause (Noise, temporary open, voltage drop) Main PCB failure

Check point 1. Reset power supply and operate

Does error indication show again?

If no, go to "[Check point 1-2](#)".



Check point 2. Replace the main PCB

Replace the main PCB.



End

Check point 1-2. Check external cause

- Check if temporary voltage drop was not generated.
- Check if momentary open was not generated.
- Check if ground is connection correctly or there are no related cables near the power line.



End

2-20. E: 64. PFC circuit error (Outdoor unit)

Indicator	Indoor unit	Operation indicator	6 time flash
		Timer indicator	4 time flash
		Economy indicator	Continuous flash
		Error code	E: 64
Detective actuator	Outdoor unit	Main PCB	<ul style="list-style-type: none"> When inverter input DC voltage is higher than 415 V for over 3 seconds, the compressor stops. If the same operation is repeated 5 times, the compressor stops permanently.
Forecast of cause			External cause
			Connector connection failure
			Main PCB failure

Check point 1. Check external cause at indoor and outdoor (Voltage drop or Noise)

- Instant drop: Check if there is a large load electric apparatus in the same circuit.
- Momentary power failure: Check if there is a defective contact or leak current in the power supply circuit.
- Noise: Check if there is any equipment causing harmonic wave near electric line. (Neon bulb or electric equipment that may cause harmonic wave)
Check the complete insulation of grounding.



Check point 2. Check connection of Connector

- Check if connector is removed.
- Check erroneous connection.
- Check if cable is open.

→ Upon correcting the removed connector or mis-wiring, reset the power.



Check point 3. Replace the main PCB

If check point 1 to 2 do not improve the symptom, replace the main PCB.



End

2-21. E: 65. IPM error (Outdoor unit)

Indicator	Indoor unit	Operation indicator	6 time flash
		Timer indicator	5 time flash
		Economy indicator	Continuous flash
		Error code	E: 65
Detective actuator	Outdoor unit	Main PCB	<ol style="list-style-type: none"> 1. When more than normal operating current to IPM in main PCB flows, the compressor stops. 2. After the compressor restarts, if the same operation is repeated within 40 seconds, the compressor stops again. 3. If 1. and 2. repeats 5 times, the compressor stops permanently.
		Compressor	
		Fan motor	
Forecast of cause		Defective connection of electrical components Outdoor fan operation failure Outdoor heat exchanger clogged Compressor failure Main PCB failure	

Check point 1. Check connections of outdoor unit electrical components

- Check if the terminal connection is loose.
- Check if connector is removed.
- Check erroneous connection.
- Check if cable is open.

→ Upon correcting the removed connector or mis-wiring, reset the power.



Check point 2. Check outdoor fan and heat exchanger

- Is there anything obstructing the air distribution circuit?
- Is there any clogging of outdoor heat exchanger?
- Is the fan rotating by hand when operation is off?

→ If the fan motor is locked, replace it.



Check point 3. Check outdoor fan

Check outdoor fan motor. (Refer to "[E: 97. Outdoor unit fan motor error \(Outdoor unit\)](#)" on page 03-53.)

→ If the fan motor is failure, replace it.



Check point 4. Check compressor

Check compressor. (Refer to inverter compressor in "[Service parts information](#)".)



Check point 5. Replace main PCB

If Check point 1 to 4 do not improve the symptom, change main PCB.



End

2-22. E: 71. Discharge thermistor error (Outdoor unit)

Indicator	Indoor unit	Operation indicator	7 time flash
		Timer indicator	1 time flash
		Economy indicator	Continuous flash
		Error code	E: 71
Detective actuator	Outdoor unit main PCB	When discharge pipe temperature thermistor open or short circuit is detected at power on or while running the compressor	
	Discharge pipe temperature thermistor		
Forecast of cause		Connector failure	
		Thermistor failure	
		Main PCB failure	

Check point 1. Check connection of connector

- Check if connector is loose or removed.
- Check erroneous connection.
- Check if thermistor cable is open

→ Reset power when reinstalling due to removed connector or incorrect wiring.



Check point 2. Remove connector and check thermistor resistance value

- For the discharge temperature thermistor resistance value, refer to "[Thermistor resistance values](#)" on page 03-82.
- If thermistor is either open or shorted, replace it and reset the power.

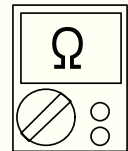

Check point 3. Check voltage of main PCB

Make sure circuit diagram of outdoor unit and check terminal voltage at thermistor (DC 5.0 V).

NOTE: For details of thermistor connector, refer to "[Wiring diagrams](#)" in Chapter 2. TECHNICAL DATA AND PARTS LIST on page 02-14.

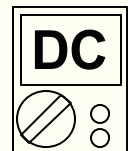

If the voltage does not appear, replace main PCB.



End

2-23. E: 73. Outdoor unit heat exchanger liquid outlet thermistor error (Outdoor unit)

Indicator	Indoor unit	Operation indicator	7 time flash
		Timer indicator	3 time flash
		Economy indicator	Continuous flash
		Error code	E: 73
Detective actuator	Outdoor unit main PCB	When heat exchanger temperature thermistor open or short circuit is detected at power on or while running the compressor	
	Heat exchanger temperature thermistor		
Forecast of cause			Connector failure
			Thermistor failure
			Main PCB failure

Check point 1. Check connection of connector

- Check if connector is loose or removed.
- Check erroneous connection.
- Check if thermistor cable is open

→ Reset power when reinstalling due to removed connector or incorrect wiring.



Check point 2. Remove connector and check thermistor resistance value

- For the outdoor unit heat exchanger thermistor resistance value, refer to "[Thermistor resistance values](#)" on page 03-82.
- If thermistor is either open or shorted, replace it and reset the power.



Check point 3. Check voltage of main PCB

Make sure circuit diagram of outdoor unit and check terminal voltage at thermistor (DC 5.0 V).

NOTE: For details of thermistor connector, refer to "[Wiring diagrams](#)" in Chapter 2. TECHNICAL DATA AND PARTS LIST on page 02-14.

If the voltage does not appear, replace main PCB.



End

2-24. E: 74. Outdoor temperature thermistor error (Outdoor unit)

Indicator	Indoor unit	Operation indicator	7 time flash
		Timer indicator	4 time flash
		Economy indicator	Continuous flash
		Error code	E: 74
Detective actuator	Outdoor unit main PCB	When outdoor temperature thermistor open or short circuit is detected at power on or while running the compressor	
	Outdoor temperature thermistor		
Forecast of cause		Connector failure	
		Thermistor failure	
		Main PCB failure	

Check point 1. Check connection of connector

- Check if connector is loose or removed.
- Check erroneous connection.
- Check if thermistor cable is open

-> Reset power when reinstalling due to removed connector or incorrect wiring.



Check point 2. Remove connector and check thermistor resistance value

- For the outdoor temperature thermistor resistance value, refer to "[Thermistor resistance values](#)" on page 03-82.
- If thermistor is either open or shorted, replace it and reset the power.



Check point 3. Check voltage of main PCB

Make sure circuit diagram of outdoor unit and check terminal voltage at thermistor (DC 5.0 V).

NOTE: For details of thermistor connector, refer to "[Wiring diagrams](#)" in Chapter 2. TECHNICAL DATA AND PARTS LIST on page 02-14.



If the voltage does not appear, replace main PCB.



End

2-25. E: 84. Current sensor error (Outdoor unit)

Indicator	Indoor unit	Operation indicator	8 time flash
		Timer indicator	4 time flash
		Economy indicator	Continuous flash
		Error code	E: 84
Detective actuator	Outdoor unit	Main PCB	When input current sensor has detected 0 A, while inverter compressor is operating at higher than 56 rps, after 1 minute upon starting the compressor. (Except during the defrost operation)
		Inverter PCB	
Forecast of cause		Defective connection of electrical components	
		External cause	
		Inverter PCB failure	
		Main PCB failure	

Check point 1. Reset power supply and operate

Does error indication show again?

If no, go to "[Check point 1-2](#)".



Check point 2. Check connections of outdoor unit electrical components

- Check if the terminal connection is loose.
- Check if connector is removed.
- Check erroneous connection.
- Check if cable is open.

Upon correcting the removed connector or miswiring, reset the power.



Check point 3. Replace the Inverter PCB

If Check point 1, 2 do not improve the symptom, replace the Inverter PCB.

If the model does not have an Inverter PCB, go to "[Check point 4](#)".



Check point 4. Replace the Main PCB

If Check point 3 do not improve the symptom, replace the Main PCB.



End

Check point 1-2. Check external cause at Indoor and Outdoor (Voltage drop or Noise)

- Instant drop: Check if there is a large load electric apparatus in the same circuit.
- Momentary power failure: Check if there is a defective contact or leak current in the power supply circuit.
- Noise: Check if there is any equipment causing harmonic wave near electric line. (Neon bulb or electric equipment that may cause harmonic wave)
Check the complete insulation of grounding.

**End**

2-26. E: 94. Over current error (Outdoor unit)

Indicator	Indoor unit	Operation indicator	9 time flash
		Timer indicator	4 time flash
		Economy indicator	Continuous flash
		Error code	E: 94
Detective actuator	Outdoor unit	Main PCB	Protection stop by over-current generation after inverter compressor start processing completed generated consecutively 10 times. NOTE: The number of generations is reset when the compressor starts up.
		Compressor	
Forecast of cause			Outdoor unit fan operation defective, foreign matter on heat-exchanger, excessive rise of ambient temperature
			Main PCB failure
			Inverter compressor failure (lock, winding short)

Check point 1. Check the outdoor unit fan operation, heat-exchanger, ambient temperature

- No obstructions in air passages?
- Heat exchange fins clogged
- Outdoor unit fan motor check
- Ambient temperature not raised by the effect of other heat sources?
- Discharged air not sucked in?



Check point 2. Replace main PCB

If Check point 1 do not improve the symptom, change main PCB.



Check point 3. Replace compressor

If Check point 2 do not improve the symptom, change compressor.



End

2-27. E: 95. Compressor motor control error (Outdoor unit)

Indicator	Indoor unit	Operation indicator	9 time flash
		Timer indicator	5 time flash
		Economy indicator	Continuous flash
		Error code	E: 95
Detective actuator	Outdoor unit	Main PCB	<ol style="list-style-type: none"> 1. When running the compressor, if the detected rotor location is out of phase with actual rotor location more than 90°, the compressor stops. 2. After the compressor restarts, if the same operation is repeated within 40 seconds, the compressor stops again. 3. If 1. and 2. repeats 5 times, the compressor stops permanently.
		Compressor	
Forecast of cause		Defective connection of electrical components	
		Main PCB failure	
		Compressor failure	

Check point 1. Check Noise from Compressor

Turn on Power and check operation noise.
→ If an abnormal noise show, replace compressor.



Check point 2. Check connection of around the compressor components

For compressor terminal, main PCB

- Check if connector is removed.
- Check erroneous connection.
- Check if cable is open. (Refer to inverter compressor in "[Service parts information](#)" on page 03-74.)

→ Upon correcting the removed connector or mis-wiring, reset the power.



Check point 3. Replace the main PCB

If Check point 1, 2 do not improve the symptom, replace the main PCB.



Check point 4. Replace compressor

If Check point 3 do not improve the symptom, change compressor.



End

2-28. E: 97. Outdoor unit fan motor error (Outdoor unit)

Indicator	Indoor unit	Operation indicator	9 time flash
		Timer indicator	7 time flash
		Economy indicator	Continuous flash
		Error code	E: 97
Detective actuator	Outdoor unit	Main PCB	<ol style="list-style-type: none"> When outdoor fan rotation speed is less than 100 rpm in 20 seconds after fan motor starts, fan motor stops. After fan motor restarts, if the same operation within 60 seconds is repeated 3 times in a row, compressor and fan motor stops. If 1. and 2. repeats 5 times in a row, compressor and fan motor stops permanently.
		Fan motor	
Forecast of cause		Fan rotation failure	
		Motor protection by surrounding temperature rise	
		Main PCB failure	
		Outdoor unit fan motor	

Check point 1. Check rotation of fan

Rotate the fan by hand when operation is off. (Check if fan is caught, dropped off or locked motor)
→ If fan or bearing is abnormal, replace it.



Check point 2. Check ambient temperature around motor

Check excessively high temperature around the motor. (If there is any surrounding equipment that causes heat)
→ Upon the temperature coming down, restart operation.



Check point 3. Check outdoor unit fan motor

Check outdoor unit fan motor. (Refer to outdoor unit fan motor in "[Service parts information](#)" on page 03-74.)
→ If outdoor unit fan motor is abnormal, replace outdoor unit fan motor and main PCB.



Check point 4. Check output voltage of main PCB

Check outdoor unit circuit diagram and the voltage. (Measure at main PCB side connector)

NOTE: For details of wiring diagram, refer to "[Wiring diagrams](#)" in Chapter 2. TECHNICAL DATA AND PARTS LIST on page 02-14.



Read wire	DC voltage
Red—Black	306 to 374 V
White—Black	15±1.5 V

-> If the voltage is not correct, replace Main PCB.



End

2-29. E: 99. 4-way valve error (Outdoor unit)

Indicator	Indoor unit	Operation indicator	9 time flash
		Timer indicator	9 time flash
		Economy indicator	Continuous flash
		Error code	E: 99
Detective actuator	Indoor unit	main PCB	When the indoor heat exchanger temperature is compared with the room temperature, and either following condition is detected continuously two times, the compressor stops. Indoor heat exchanger temp. - Room temp. > 10°C (Cooling or Dry operation) Indoor heat exchanger temp. - Room temp. < -10°C (Heating operation) If the same operation is repeated 5 times, the compressor stops permanently.
	Heat exchanger temperature thermistor		
	Room temperature thermistor		
	4-way valve		
Forecast of cause			Connector connection failure
			Thermistor failure
			Coil failure
			4-way valve failure
			Main PCB failure

Check point 1. Check connection of connector

- Check if connector is removed.
- Check erroneous connection.
- Check if thermistor cable is open.

→ Upon correcting the removed connector or mis-wiring, reset the power.



Check point 2. Check each thermistor

- Isn't it fallen off the holder?
- Is there a cable pinched?

Check characteristics of room thermistor and indoor unit heat exchanger thermistor.

For the thermistor resistance value, refer to "[Thermistor resistance values](#)" on page 03-82.

→ If defective, replace the thermistor.



Check point 3. Check the solenoid coil and 4-way valve

NOTE: Refer solenoid coil and 4-way valve in "[Service parts information](#)" on page 03-74.

- **Solenoid coil**
Remove P60 from PCB and check the resistance value of coil. Resistance value is 2.780 kΩ (at 20°C).
→ If it is open or abnormal resistance value, replace solenoid coil.
- **4-way valve**
Check each piping temperature, and the location of the valve by the temperature difference.
If the value location is not proper, replace 4-way valve.

**Check point 4. Replace main PCB**

If Check Point 1 to 3 do not improve the symptom, replace main PCB.



End

2-30. E: A1. Discharge temperature error (Outdoor unit)

Indicator	Indoor unit	Operation indicator	10 time flash
		Timer indicator	1 time flash
		Economy indicator	Continuous flash
		Error code	E: A1
Detective actuator	Outdoor unit main PCB	Protection stop by discharge temperature $\geq 110^{\circ}\text{C}$ during compressor operation generated 2 times within 24 hours.	
	Discharge temperature thermistor		
Forecast of cause	3-way valve not opened		
	EEV or capillary tube defective, strainer clogged		
	Outdoor unit operation failure, foreign matter on heat exchanger		
	Discharge temperature thermistor failure		
	Insufficient refrigerant		
	Main PCB failure		

Check point 1. Check if 3-way valve is open

If the 3-way valve is closed, open the 3-way valve and check operation.

NOTE: For cooling operation, check gas side of the 3-way valve.

For heating operation, check liquid side of the 3-way valve.



Check point 2. Check any of the electronic expansion valve (EEV), capillary tube, or strainer, or all

- Check if EEV open or there is a capillary tube defect.
Refer to outdoor unit Electronic Expansion Valve (EEV) or Capillary tube in "[Service parts information](#)" on page 03-74.
- Check the strainer clogging.



Check point 3. Check the outdoor unit fan and heat exchanger

- Check for foreign object at heat exchanger
- Check if fan can be rotated by hand.
- Check the motor. (Refer to outdoor unit fan motor in "[Service parts information](#)" on page 03-74.)



Check point 4. Check the discharge thermistor

The discharge temperature thermistor characteristics check. (Check by disconnecting thermistor from PCB.)

NOTE: For the characteristics of the thermistor, refer to "[Thermistor resistance values](#)" on page 03-82.



Check point 5. Check the refrigerant amount

Check the refrigerant leakage.



Check point 6. Replace the main PCB

If check point 1 to 5 do not improve the symptom, replace the main PCB.



End

3. Troubleshooting without error code

3-1. Indoor unit—No power

Forecast of cause	Power supply failure
	External cause
	Electrical components defective

Check point 1. Check installation condition

- Isn't the breaker down?
- Check loose or removed connection cable.

-> If abnormal condition is found, correct it by referring to the installation manual or the *DESIGN & TECHNICAL MANUAL*.



Check point 2. Check external cause at indoor and outdoor (voltage drop or noise)

- Instant drop: Check if there is a large load electric apparatus in the same circuit.
- Momentary power failure: Check if there is a defective contact or leak current in the power supply circuit.
- Noise: Check if there is any equipment causing harmonic wave near electric line. (Neon bulb or electric equipment that may cause harmonic wave)
Check the complete insulation of grounding.



Check point 3. Check electrical components

Check the voltage of power supply.

Check if AC 207 to 253 V appears at outdoor unit terminal L—N.

-> If no, go to "[Check point 1](#)" and "[Check point 2](#)".



- Check fuse in the Filter PCB.
If fuse is open, check if the wiring between terminal and filter PCB is loose, and replace the Filter PCB.
- Check varistor in the Filter PCB.
If varistor is defective, there is a possibility of an abnormal power supply.
Check the correct power supply and replace the Filter PCB.
Upon checking the normal power supply, replace the Filter PCB.



End

3-2. Outdoor unit—No power

Forecast of cause	Power supply failure
	External cause
	Electrical components defective

Check point 1. Check installation condition

- Is the circuit breaker on or off?
- Check loose or removed connection cable.

→ If abnormal condition is found, correct it by referring to the installation manual or the *DESIGN & TECHNICAL MANUAL*.



Check point 2. Check external cause at indoor and outdoor (voltage drop or noise)

- Instant drop: Check if there is a large load electric apparatus in the same circuit.
- Momentary power failure: Check if there is a defective contact or leak current in the power supply circuit.
- Noise: Check if there is any equipment causing harmonic wave near electric line. (Neon bulb or electric equipment that may cause harmonic wave)
Check the complete insulation of grounding.



Check point 3. Check electrical components

Check the voltage of power supply.

Check if AC 207 to 253 V appears at outdoor unit terminal L—N

→ If no, go to "[Check point 1](#)" and "[Check point 2](#)".

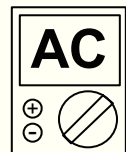

- Check fuse in main PCB.
If fuse is open, check if the wiring between terminal and main PCB is loose, and replace the Main PCB.
- Check varistor in the Main PCB.
If varistor is defective, there is a possibility of an abnormal power supply. Check the correct power supply and replace the Main PCB.
→ Upon checking the normal power supply, replace the Main PCB.



Check point 4. Replace the main PCB

If check point 1 to 3 do not improve the symptom, replace the main PCB.



End

3-3. No operation (Power is on)

Forecast of cause	Setting/ Connection failure
	External cause
	Electrical components defective

Check point 1. Check indoor and outdoor installation condition

- Indoor unit:
 - Check incorrect wiring between indoor unit and remote controller.
 - Check if there is an open cable connection.
- Are these indoor unit, outdoor unit, and remote controller suitable model names to connect?

-> If there is some abnormal condition, correct it by referring to the installation manual and "DESIGN & TECHNICAL MANUAL".



Turn off the power and check correct followings.

- Is there loose or removed communication line of indoor unit and outdoor unit?



Check point 2. Check external cause at indoor and outdoor (Voltage drop or Noise)

- Instant drop: Check if there is a large load electric apparatus in the same circuit.
- Momentary power failure: Check if there is a defective contact or leak current in the power supply circuit.
- Noise: Check if there is any equipment causing harmonic wave near electric line. (Neon bulb or electric equipment that may cause harmonic wave)
Check the complete insulation of grounding.



Check point 3. Check wired remote controller and controller PCB

Check voltage at CN13 (terminal 1—3) of main PCB.

(Power supply to remote controller)

- If it is DC 12 V, remote controller is failure. (The controller PCB is normal)
-> Replace remote controller.
- If it is DC 0 V, controller PCB is failure. (Check the remote controller once again)
-> Replace controller PCB.



Check point 4. Replace main PCB

If check point 1 to 3 do not improve the symptom, change main PCB.



End

3-4. No cooling/No heating

Forecast of cause	Indoor unit error
	Outdoor unit error
	Effect by surrounding environment
	Connection pipe/Connection wire failure
	Refrigeration cycle failure

Check point 1. Check Indoor unit

- Does Indoor unit fan run in the HIGH mode?
- Is air filter dirty?
- Is heat exchanger clogged?
- Check if energy save function is operated.



Check point 2. Check outdoor unit operation

- Check if outdoor unit is operating.
- Check any objects that obstruct the air flow route.
- Check if heat exchanger is clogged.
- Is the valve open?



Check point 3. Check site condition

- Is capacity of Indoor unit fitted to the room size?
- Any windows open or direct sunlight?



Check point 4. Check indoor/outdoor installation condition

- Check connection pipe (specified pipe length and pipe diameter?)
- Check any loose or removed communication line.

→ If there is an abnormal condition, correct it by referring to the installation manual or the "DESIGN & TECHNICAL MANUAL".



Check point 5. Check Refrigeration cycle

- Check if strainer is clogged (Refer to the figure below).
- Measure gas pressure, and if there is a leakage, correct it.
- Check if EEV open or there is a capillary tube defect.
Refer to outdoor unit Electronic Expansion Valve (EEV) or Capillary tube in "[Service parts information](#)" on page 03-74.
- Check compressor.
Refer to compressor in "[Service parts information](#)" on page 03-74.
Refer to inverter compressor in "[Service parts information](#)" on page 03-74.

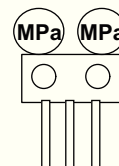

NOTE: When recharging the refrigerant, make sure to perform vacuuming, and recharge the specified amount.



End

NOTES:

- Strainer normally does not have temperature difference between inlet and outlet as shown below.

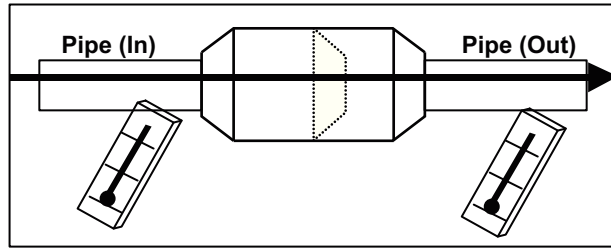

- If there is a difference like shown below, there is a possibility of inside clogged. In this case, replace the strainer.

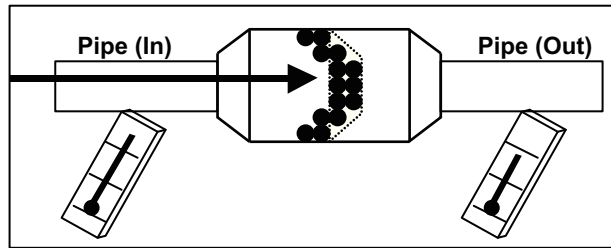

3-5. Abnormal noise

Forecast of cause	Abnormal installation (indoor unit/outdoor unit)
	Fan failure (indoor unit/outdoor unit)
	Compressor failure (outdoor)

Diagnosis method when abnormal noise is occurred

Abnormal noise is coming from Indoor unit.
(Check and correct followings)



- Is main unit installed in stable condition?
- Is the installation of air suction grille and front panel normal?



- Is fan broken or deformed?
- Is the screw of fan loose?
- Is there any object which obstruct the fan rotation?



End

Abnormal noise is coming from Outdoor unit.
(Check and correct followings)



- Is main unit installed in stable condition?
- Is fan guard installed normally?



- Is fan broken or deformed?
- Is the screw of fan loose?
- Is there any object which obstruct the fan rotation?



Check if vibration noise by loose bolt or contact noise of piping is happening.



Is compressor locked?

- Check Compressor
Refer to compressor and inverter compressor in "[Service parts information](#)" on page 03-74.



End

3-6. Water leaking

Forecast of cause	Erroneous installation
	Drain hose failure

Diagnosis method when water leak occurs

- Is main unit installed in stable condition?
- Is main unit broken or deformed at the time of transportation or maintenance?



- Is drain hose connection loose?
- Is there a trap in drain hose?
- Is drain hose clogged?



Is fan rotating?



End

Diagnosis method when water is spitting out

Is the filter clogged?



Check gas pressure and correct it if there was a gas leak.

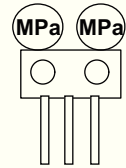

End

4. Troubleshooting with error code (For wireless LAN adapter)

4-1. E: 18. External communication error between indoor unit and wireless LAN adapter

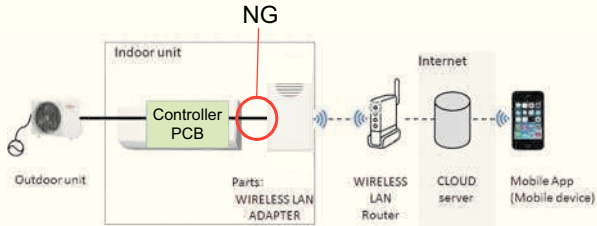
Indicator	Indoor unit	Operation indicator	1 time flash
		Timer indicator	8 time flash
		Economy indicator	Continuous flash
		Wireless LAN indicator	Flashing slowly
		Error code	E: 18
	Mobile app		E: 18.1
Detective actuator	Wireless LAN adapter PCB	After receiving a signal from the wireless LAN adapter, the same signal has not been received for 15 seconds.	
	Controller PCB		
Forecast of cause	Connection between indoor unit and wireless LAN adapter failure		
	Wireless LAN adapter PCB failure		
	Controller PCB failure		

Check point 1. Check the connection

- Check any loose or removed connection of between the wireless LAN adapter PCB and controller PCB.
-> If there is abnormal condition, correct it.
- Check the connection condition on the controller PCB.
-> If there is loose connector, open cable or mis-wiring, correct it.



Check point 2. Replace wireless LAN adapter.

If check point 1 do not improve the symptom, replace the wireless LAN adapter and cancel the registration of air conditioner on the Mobile app.
After replacing the adapter, perform the pairing on the Mobile app.

For the method of the Mobile app, refer to "[Mobile app setting method](#)" on page 03-72.



Check point 3. Replace controller PCB

If check point 1 to 2 do not improve the symptom, replace the controller PCB.



End

4-2. Network communication error between wireless LAN router and wireless LAN adapter

Indicator	Indoor unit	Operation indicator	No indication
		Timer indicator	No indication
		Economy indicator	No indication
		Wireless LAN indicator	Flashing slowly
		Error code	—
	Mobile app		No indication
Detective actuator	Wireless LAN router	When the not connection between wireless LAN adapter and wireless LAN router.	
	Wireless LAN adapter PCB		
Forecast of cause	Connection cable failure of wireless LAN router		
	Connection between wireless LAN adapter and wireless LAN router failure		
	Wireless LAN router failure		
	Wireless LAN adapter PCB failure		

Check point 1. Check the connection cable

Check the connection cable on the wireless LAN router.

-> If there is loose connector, open cable or mis-wiring, correct it.



Check point 2. Check the connection status.

Check the connection status to the Internet and wireless LAN router.

-> If the wireless LAN router is not connected to the Internet, check the transmission between wireless LAN products (ex. PC or game console, etc.) other than air conditioner and wireless LAN router.

If no, go to "[Check point 2-2](#)".



Check point 3. Turn on the power again of air conditioner.

If check point 1 to 2 do not improve the symptom, turn on the power of the air conditioner again and wait for 60 seconds.



Check point 4. Replace wireless LAN adapter.

If check point 3 do not improve the symptom, replace the wireless LAN adapter and cancel the registration of air conditioner on the Mobile app.
After replacing the adapter, perform the pairing on the Mobile app.

For the method of the Mobile app, refer to "[Mobile app setting method](#)" on page 03-72.



End

Check point 2-2. Check the transmission state

Check the wireless transmission state of the wireless LAN router (indicator lamp status).
-> If the wireless transmission from the wireless LAN router has not been outgoing, inquire to the wireless LAN router maker.



End

4-3. E: 18. Communication error

Indicator	Indoor unit	Operation indicator	1 time flash
		Timer indicator	8 time flash
		Economy indicator	Continuous flash
		Wireless LAN indicator	Flashing slowly
		Error code	E: 18
	Mobile app		E: 18.1
Detective actuator	Wireless LAN router	Indoor unit controller PCB	<p>When the external communication error between indoor unit and wireless LAN adapter and network communication error between wireless LAN router and wireless LAN adapter has occurred simultaneously.</p>
	Wireless LAN adapter PCB		
Forecast of cause			Connection cable failure of wireless LAN router
			Wireless LAN router failure
			Connection between indoor unit and wireless LAN adapter failure
			Connection between wireless LAN adapter and wireless LAN router failure
			Wireless LAN adapter PCB failure
			Controller PCB failure

Check point 1. Check the connection

- Check any loose or removed connection of between the wireless LAN adapter PCB and controller PCB.
-> If there is abnormal condition, correct it.
- Check the connection condition on the controller PCB.
-> If there is loose connector, open cable or mis-wiring, correct it.



Check point 2. Replace wireless LAN adapter.

If check point 1 do not improve the symptom, replace the wireless LAN adapter and cancel the registration of air conditioner on the Mobile app.
After replacing the adapter, perform the pairing on the Mobile app.

For the method of the Mobile app, refer to ["Mobile app setting method"](#) on page 03-72.



Check point 3. Replace controller PCB

If check point 1 to 2 do not improve the symptom, replace the controller PCB.



Check point 4. Check the connection cable

Check the connection cable on the wireless LAN router.
-> If there is loose connector, open cable or mis-wiring, correct it.

**Check point 5. Check the connection status.**

Check the connection status to the Internet and wireless LAN router.
-> If the wireless LAN router is not connected to the Internet, check the transmission between wireless LAN products (ex. PC or game console, etc.) other than air conditioner and wireless LAN router.

If no, go to "[Check point 5-2](#)".

**Check point 6. Turn on the power again of air conditioner.**

If check point 1 to 2 do not improve the symptom, turn on the power of the air conditioner again and wait for 60 seconds.

**Check point 7. Replace wireless LAN adapter.**

If check point 3 do not improve the symptom, replace the wireless LAN adapter and cancel the registration of air conditioner on the Mobile app.
After replacing the adapter, perform the pairing on the Mobile app.

For the method of the Mobile app, refer to "[Mobile app setting method](#)" on page 03-72.



End

Check point 5-2. Check the transmission state

Check the wireless transmission state of the wireless LAN router (indicator lamp status).
-> If the wireless transmission from the wireless LAN router has not been outgoing, inquire to the wireless LAN router maker.



End

4-4. E: 18. Wireless LAN adapter non-energized

Indicator	Indoor unit	Operation indicator	1 time flash
		Timer indicator	8 time flash
		Economy indicator	Continuous flash
		Wireless LAN indicator	No indication
		Error code	E: 18
	Mobile app		No indication
Detective actuator	Indoor unit controller PCB	When the voltage (DC 12 V) does not output from the controller PCB.	
	Wireless LAN adapter PCB		
Forecast of cause		Indoor unit controller PCB failure	
		Wireless LAN adapter PCB failure	
		Wiring connection failure	

Check point 1. Check the connection.

- Check any loose or removed connection of between the wireless LAN adapter PCB and controller PCB.
-> If there is abnormal condition, correct it.
- Check the connection condition on the controller PCB.
-> If there is loose connector, open cable or mis-wiring, correct it.



Check point 2. Check the wireless LAN adapter PCB and the controller PCB

Check voltage at CN13 (terminal 1—3) of main PCB.
(Power supply to remote controller)

- If it is DC 0 V, controller PCB is failure.
-> Replace controller PCB.
- If it is DC 12 V, wireless LAN adapter PCB is failure.
-> Replace the wireless LAN adapter and cancel the registration of air conditioner on the Mobile app.



After replacing the adapter, perform the pairing on the Mobile app.

For the method of the Mobile app, refer to "[Mobile app setting method](#)" on page 03-72.



End

4-5. Mobile app setting method

■ Air conditioner delete method

When the wireless LAN adapter is replaced, delete of all air conditioner is necessary on the mobile app.

1. Launch the mobile app.



2. Tap the  icon to display the Setting screen.

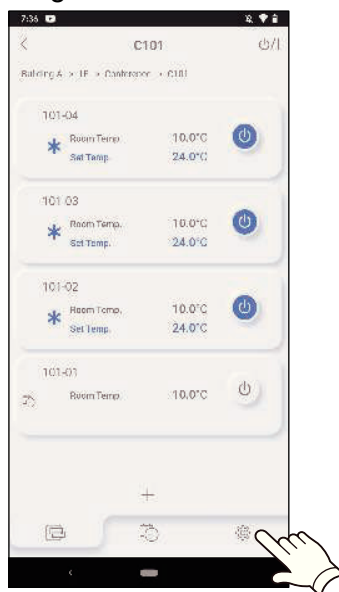

3. Tap the “Air conditioner editing”.

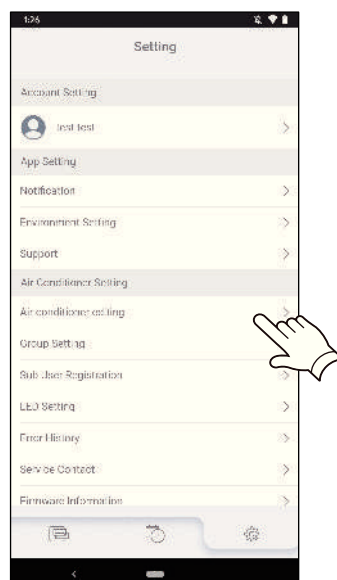

4. Tap the air conditioner to be deleted.

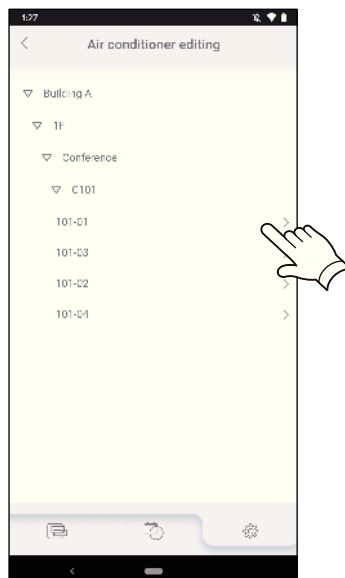

5. Tap the Delete button.

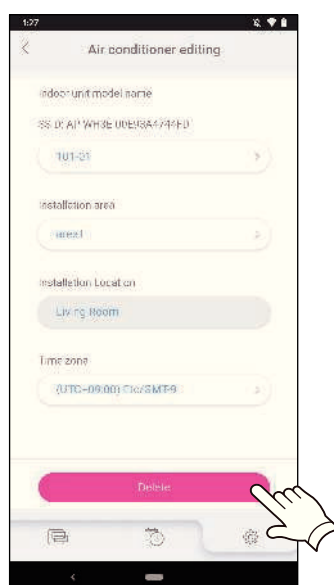

6. Tap the OK button.



7. Deletion of the air conditioner registered in the mobile app is completed.

5. Service parts information

5-1. Compressor

Diagnosis method of compressor (If outdoor unit LED displays error, refer to troubleshooting)

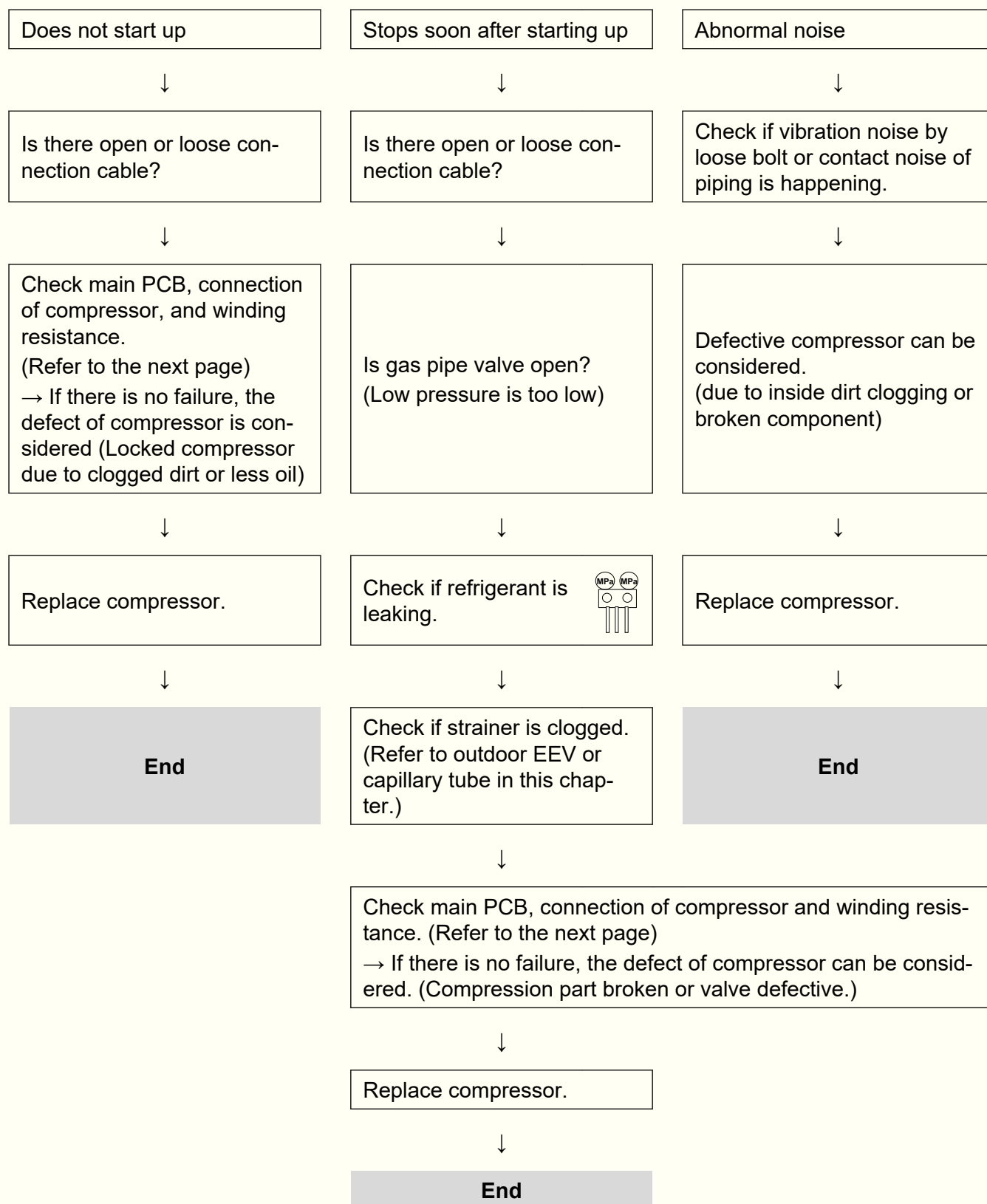

5-2. Inverter compressor

TROUBLESHOOTING

TROUBLESHOOTING

Check point 1. Check the terminal connection.

- Check the following terminal connections of the compressor. (Loosening or incorrect wiring.)

R (U): Red
S (V): White
C (W): Black

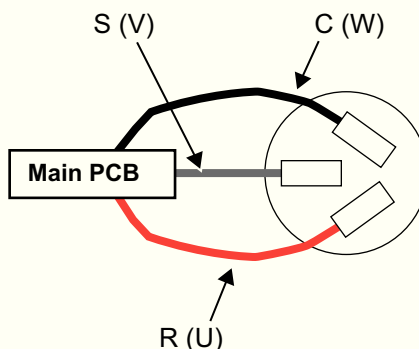

- Check the following terminal connections of the Main PCB. (Loosening or incorrect wiring.)

W400 (U): Red
W401 (V): White
W402 (W): Black

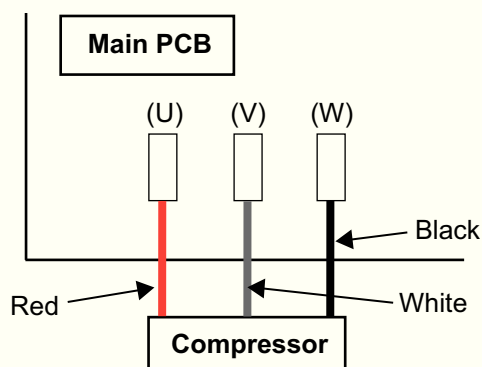

Check point 2. Check the winding resistance.

Check the winding resistance of each terminal.

Resistance value: $1.975 \Omega \pm 7\%$ at 25°C

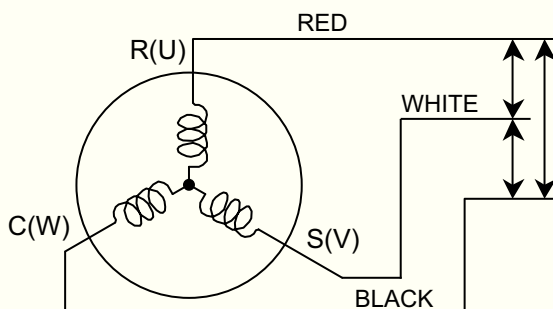
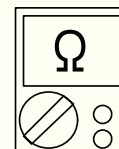

→ If the resistance value is 0Ω or infinite, replace the compressor.



Check point 3. Replace the Inverter PCB.

If check point 1 to 2 do not improve the symptom, replace the Inverter PCB.

5-3. Outdoor unit Electronic Expansion Valve (EEV)

Check point 1. Check connections

Check connection of connector. (Loose connector or open cable)

NOTE: For details of wiring diagram, refer to "Wiring diagrams" in Chapter 2. TECHNICAL DATA AND PARTS LIST on page 02-14.

Check point 2. Check coil of EEV

Remove connector, check each winding resistance of coil.

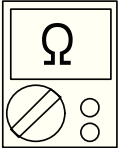
Read wire	Resistance value
1 (Red) - 2 (Blue)	$46 \Omega \pm 4 \Omega$ at 20°C 
1 (Red) - 3 (Orange)	
1 (Red) - 4 (Yellow)	
1 (Red) - 5 (White)	

→ If Resistance value is abnormal, replace EEV.

Check point 3. Check Voltage from main PCB

Remove connector and check voltage (DC 12 V)

→ If it does not appear, replace main PCB.



Check point 4. Check noise at start up

Turn on the power and check the operation noise.

→ If an abnormal noise does not show, replace main PCB.

Check point 5. Check Opening and Closing Operation of Valve

When valve is closed, it has a temp. difference between inlet and outlet

CLOSE
Example : Hot Gas

Pipe (In)
Hi TEMP.

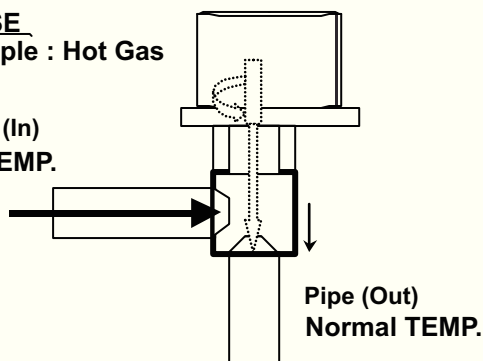

If it is open, it has no temp. difference between inlet and outlet

OPEN
Example : Hot Gas

Pipe (In)
Hi TEMP.

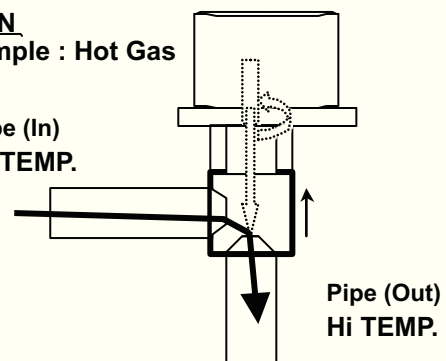

Check point 6. Check strainer

- Strainer normally does not have temperature difference between inlet and outlet as shown below.

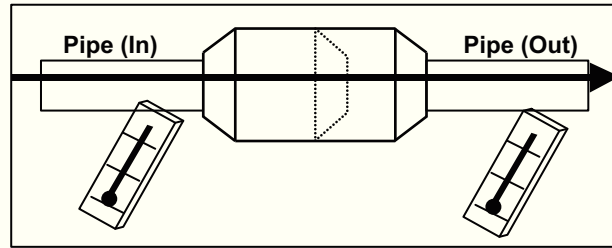

- If there is a difference like shown below, there is a possibility of inside clogged. In this case, replace the strainer.

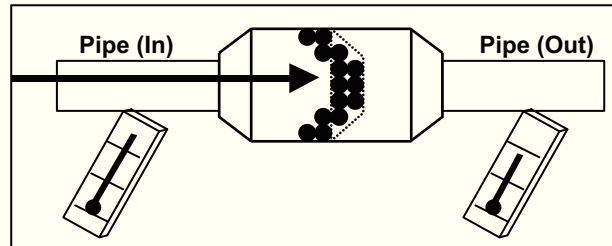

5-4. Indoor unit fan motor

Check point 1. Check rotation of fan

Rotate the fan by hand when operation is off.
 (Check if fan is caught, dropped off or locked motor)
 → If fan or bearing is abnormal, replace it.

Check point 2. Check resistance of indoor fan motor

Refer to below. Circuit-test “Vm” and “GND” terminal

NOTE: Vm: DC voltage, GND: Ground terminal

→ If they are short-circuited (below 300 kΩ), replace indoor fan motor and controller PCB.

Pin number (wire color)	Terminal function (symbol)
1 (Red)	DC voltage (Vm)
2	No function
3	No function
4 (Black)	Ground terminal (GND)
5 (White)	Control voltage (Vcc)
6 (Yellow)	Speed command (Vsp)
7 (Blue)	Feed back (FG)

5-5. Outdoor unit fan motor

Check point 1. Check rotation of fan

Rotate the fan by hand when operation is off.
 (Check if fan is caught, dropped off or locked motor)
 → If fan or bearing is abnormal, replace it.

Check point 2. Check resistance of outdoor fan motor

Refer to below. Circuit-test "Vm" and "GND" terminal

NOTE: Vm: DC voltage, GND: Ground terminal

→ If they are short-circuited (below 300 kΩ), replace outdoor fan motor and controller PCB.

Pin number (wire color)	Terminal function (symbol)
1 (Red)	DC voltage (Vm)
2	No function
3	No function
4 (Black)	Ground terminal (GND)
5 (White)	Control voltage (Vcc)
6 (Yellow)	Speed command (Vsp)
7 (Brown)	Feed back (FG)

5-6. Reactor assy

Check point 1. Appearance check

No fissures, breaks, damage, etc. at the body and winding section, terminals section?

Check point 2. Electric check

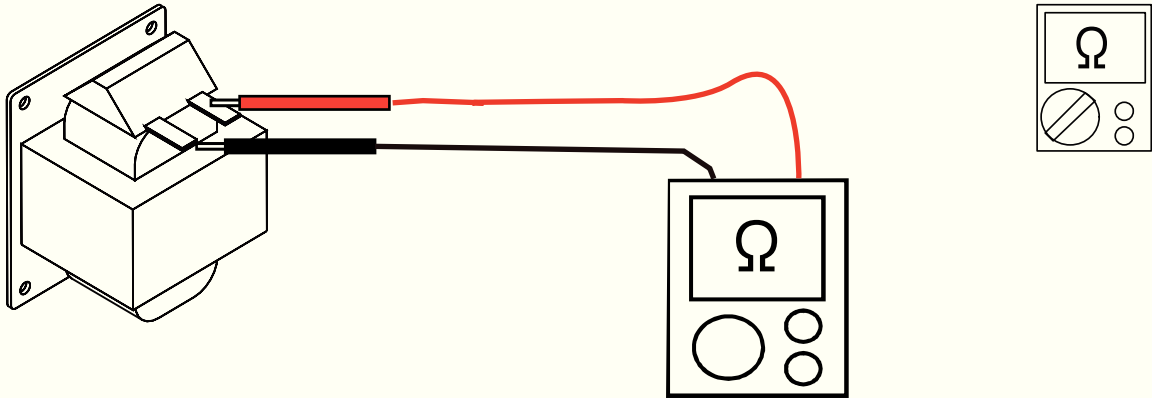

- Set the tester to the "Resistance" mode, and check for open/short between both ends of the reactor wire (or connector).
- Judge the result of 1. as follows:

Short	Normal
Open	Abnormal (open)

NOTE: Reference value of DC resistance of reactor used:

- 415.9 mΩ (at 25°C) (07, 09, and 12 models)
- 323.23 mΩ (at 25°C) (14 model)

5-7. 4-way valve coil (solenoid coil)/4-way valve

Check point 1. Check connection

- Check the connection of connector P60.

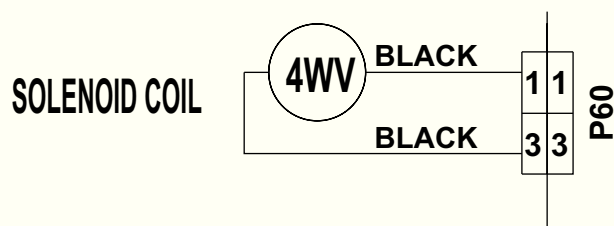

Check Point 2 : Check solenoid coil

Remove P60 from PCB and check the resistance value of coil.

Resistance value $\approx 2.780 \text{ k}\Omega$



→ If it is Open or abnormal resistance value, replace solenoid coil.



Check Point 3: Check the 4-way valve operation

Check each piping temperature, and confirm the location of the valve by the temperature difference

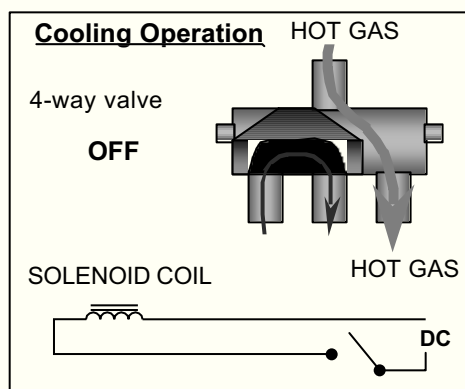
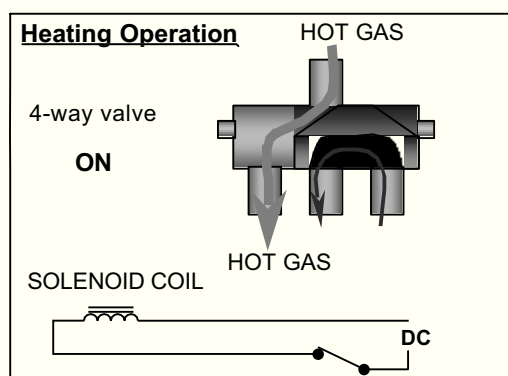

→ If the valve location is not proper, replace the 4-way valve.



Check Point 4: Replace Main PCB

If none of Checks 1 to 3 apply, replace the Main PCB.

6. Thermistor resistance values

6-1. Indoor unit

■ Room temperature thermistor

Temperature (°C)	Resistance (kΩ)	Voltage (V)
-10.0	58.25	0.73
-5.0	44.03	0.93
0.0	33.62	1.15
5.0	25.93	1.39
10.0	20.18	1.66
15.0	15.84	1.94
20.0	12.54	2.22
25.0	10.00	2.50
30.0	8.04	2.77
35.0	6.51	3.03
40.0	5.30	3.27
45.0	4.35	3.49

■ Heat exchanger temperature thermistor

Temperature (°C)	Resistance (kΩ)	Voltage (V)
-30.0	1,131.91	0.21
-25.0	804.52	0.29
-20.0	579.59	0.40
-15.0	422.89	0.53
-10.0	312.27	0.69
-5.0	233.21	0.88
0.0	176.03	1.10
5.0	134.23	1.36
10.0	103.34	1.63
15.0	80.28	1.92
20.0	62.91	2.21
25.0	49.70	2.51
30.0	39.57	2.79
35.0	31.74	3.06
40.0	25.64	3.30
45.0	20.85	3.53
50.0	17.06	3.73
55.0	14.05	3.90
60.0	11.64	4.05
65.0	9.69	4.19

6-2. Outdoor unit

■ Discharge temperature thermistor

● Models: AOEH07KGCG and AOEH09KGCG

Temperature (°C)	Resistance (kΩ)	Voltage (V)
-30.0	1,013.11	0.06
-25.0	729.09	0.09
-20.0	531.56	0.12
-15.0	392.31	0.16
-10.0	292.91	0.21
-5.0	221.09	0.28
0.0	168.60	0.36
5.0	129.84	0.46
10.0	100.91	0.57
15.0	79.12	0.71
20.0	62.55	0.86
25.0	49.84	1.03
30.0	40.01	1.23
35.0	32.35	1.43
40.0	26.34	1.65
45.0	21.58	1.88
50.0	17.79	2.11
55.0	14.75	2.34
60.0	12.30	2.57
65.0	10.32	2.79
70.0	8.69	3.00
75.0	7.36	3.19
80.0	6.27	3.37
85.0	5.36	3.54
90.0	4.60	3.69
95.0	3.96	3.83
100.0	3.43	3.96
105.0	2.98	4.07
110.0	2.60	4.17
115.0	2.27	4.26
120.0	2.00	4.33

● Models: AOEH12KGCG and AOEH14KGCG

Temperature (°C)	Resistance (kΩ)	Voltage (V)
-30.0	1,000.13	0.06
-25.0	720.28	0.09
-20.0	525.51	0.12
-15.0	388.12	0.16
-10.0	289.97	0.22
-5.0	219.01	0.28
0.0	167.12	0.36
5.0	128.77	0.46
10.0	100.14	0.58
15.0	78.56	0.71
20.0	62.14	0.87
25.0	49.54	1.04
30.0	39.79	1.23
35.0	32.19	1.44
40.0	26.22	1.66
45.0	21.49	1.89
50.0	17.73	2.12
55.0	14.71	2.35
60.0	12.27	2.57
65.0	10.29	2.79
70.0	8.68	3.00
75.0	7.35	3.19
80.0	6.26	3.38
85.0	5.35	3.54
90.0	4.60	3.69
95.0	3.96	3.83
100.0	3.43	3.96
105.0	2.98	4.07
110.0	2.60	4.17
115.0	2.28	4.26
120.0	2.00	4.33

■ Heat exchanger temperature thermistor

Temperature (°C)	Resistance (kΩ)	Voltage (V)
-30.0	95.58	0.24
-25.0	68.90	0.32
-20.0	50.31	0.43
-15.0	37.19	0.57
-10.0	27.81	0.73
-5.0	21.02	0.92
0.0	16.05	1.14
5.0	12.38	1.39
10.0	9.63	1.65
15.0	7.56	1.93
20.0	5.98	2.21
25.0	4.77	2.49
30.0	3.84	2.77
35.0	3.11	3.02
40.0	2.53	3.26
45.0	2.08	3.48
50.0	1.71	3.68
55.0	1.42	3.85
60.0	1.19	4.00
65.0	1.00	4.13
70.0	0.84	4.25
75.0	0.71	4.35
80.0	0.61	4.43

■ Outdoor temperature thermistor

Temperature (°C)	Resistance (kΩ)	Voltage (V)
-30.0	224.33	0.73
-25.0	159.71	0.97
-20.0	115.24	1.25
-15.0	84.21	1.56
-10.0	62.28	1.90
-5.0	46.58	2.26
0.0	35.21	2.61
5.0	26.88	2.94
10.0	20.72	3.25
15.0	16.12	3.52
20.0	12.64	3.76
25.0	10.00	3.97
30.0	7.97	4.14
35.0	6.40	4.28
40.0	5.18	4.41
45.0	4.21	4.51
50.0	3.45	4.59
55.0	2.85	4.65

4. CONTROL AND FUNCTIONS

CONTENTS

4. CONTROL AND FUNCTIONS

1. Rotation number control of compressor.....	04-1
1-1. Cooling operation	04-1
1-2. Heating operation	04-3
1-3. Dry operation	04-4
1-4. Rotation number of compressor at normal start-up	04-4
1-5. Limitation of compressor rotation number by outdoor temperature.....	04-5
2. Auto changeover operation.....	04-7
3. Fan control.....	04-9
3-1. Indoor fan control.....	04-9
3-2. Outdoor fan control.....	04-13
4. Louver control	04-16
4-1. Horizontal louver control	04-16
4-2. Vertical louver adjustment	04-16
4-3. Swing operation.....	04-17
5. Timer operation control	04-18
5-1. Wireless remote control	04-18
5-2. Wired remote control	04-20
6. Defrost operation control	04-23
6-1. Defrost operation in heating operation stopped	04-24
7. Various control.....	04-25
7-1. Auto restart.....	04-25
7-2. MANUAL AUTO operation.....	04-25
7-3. Forced cooling operation	04-26
7-4. 10 °C HEAT operation	04-26
7-5. ECONOMY operation	04-26
7-6. POWERFUL operation	04-27
7-7. Fresh air control	04-27
7-8. Compressor preheating operation	04-27
7-9. External electrical heater control	04-28
7-10. Electronic expansion valve control	04-28
7-11. Prevention to restart for 3 minutes (3 minutes st)	04-28
7-12. 4-way valve control.....	04-29
7-13. Human sensor for energy saving	04-29
7-14. Outdoor unit low noise operation	04-30
7-15. Unit status monitoring and the detected value indication	04-30
8. Various protections.....	04-32
8-1. Discharge gas temperature over-rise prevention control	04-32
8-2. Anti-freezing control (cooling and dry mode)	04-32
8-3. Current release control	04-33
8-4. Cooling pressure over-rise protection	04-33

CONTENTS (continued)

8-5. Low outdoor temperature protection.....	04-33
8-6. High temperature and high pressure release control.....	04-34

1. Rotation number control of compressor

1-1. Cooling operation

A sensor (room temperature thermistor) built in the indoor unit body will usually perceive difference or variation between a set temperature and present room temperature, and controls the operation rotation number of the compressor.

- If the room temperature is 6.0°C higher than a set temperature, the operation rotation number of compressor will attain to maximum performance.
- If the room temperature is 1.0°C lower than a set temperature, the compressor will be stopped.
- When the room temperature is within the range of +6.0°C to -1.0°C of the setting temperature, the rotation number of compressor is controlled within the range shown in the table below. However, the maximum rotation number is limited in the range shown in the figure below based on the indoor fan mode and the outdoor temperature.

- **Rotation number range of compressor**

Unit: rps

Model name	Minimum rotation number	Maximum rotation number
ASEH07KGTG	12	67
ASEH09KGTG	12	77
ASEH12KGTG ASEH14KGTG	12	83

• Limit of maximum speed based on outdoor temperature

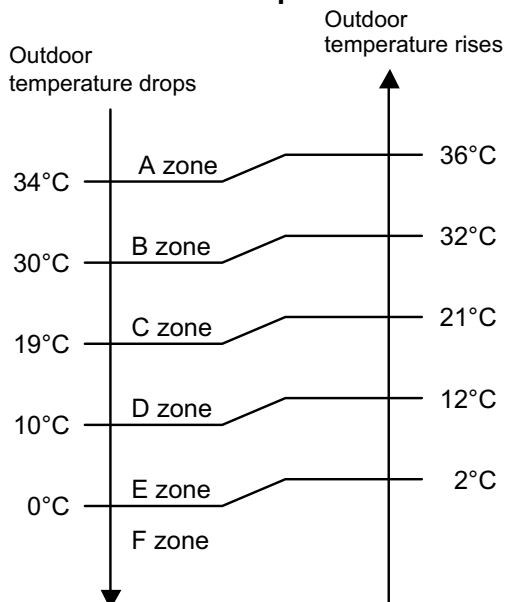

Unit: rps

Model name	Outdoor temperature zone	Indoor unit fan mode			
		HIGH	MED	LOW	QUIET
ASEH07KGTG	A zone	67	44	36	26
	B zone	67	44	36	26
	C zone	67	44	36	26
	D zone	47	38	36	26
	E zone	47	38	36	26
	F zone	47	38	36	26
ASEH09KGTG	A zone	77	47	36	26
	B zone	77	47	36	26
	C zone	77	47	36	26
	D zone	54	40	36	26
	E zone	54	40	36	26
	F zone	54	40	36	26
ASEH12KGTG	A zone	83	42	30	18
	B zone	83	42	30	18
	C zone	83	42	30	18
	D zone	58	40	28	16
	E zone	58	40	28	16
	F zone	58	40	28	16
ASEH14KGTG	A zone	83	42	30	18
	B zone	83	42	30	18
	C zone	83	42	30	18
	D zone	58	40	28	16
	E zone	58	40	28	16
	F zone	58	40	28	16

CONTROL AND FUNCTIONS

CONTROL AND FUNCTIONS

1-2. Heating operation

A sensor (room temperature thermistor) built in indoor unit body will usually perceive difference or variation between setting temperature and present room temperature, and controls operation rotation number of compressor.

- If the room temperature is 6.0°C lower than a set temperature, the operation rotation number of compressor will attain to maximum performance.
- If the room temperature is 1.0°C higher than a set temperature, the compressor will be stopped.
- When the room temperature is within the range of +1.0°C to -6.0°C of the setting temperature, the rotation number of compressor is controlled within the range shown below.

• Rotation number range of compressor

Unit: rps

Model name	Minimum rotation number	Maximum rotation number
ASEH07KGTG ASEH09KGTG ASEH12KGTG ASEH14KGTG	12	110

• Limit of maximum speed based on outdoor temperature

In heating operation, maximum rotation number is defined by outdoor temperature and fan mode.

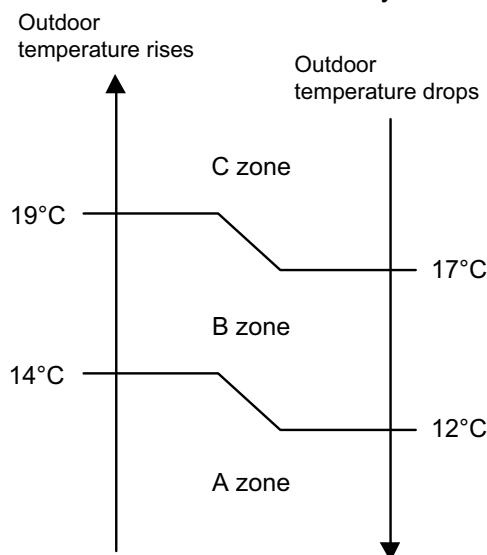

Unit: rps

Model name	Outdoor temperature zone	Indoor unit fan mode			
		HIGH	MED	LOW	QUIET
ASEH07KGTG	A zone	110	110	96	67
	B zone	96	96	89	62
	C zone	83	83	62	30
ASEH09KGTG	A zone	110	110	96	67
	B zone	110	103	89	62
	C zone	83	83	62	30
ASEH12KGTG	A zone	110	110	77	67
	B zone	110	110	72	62
	C zone	89	89	62	40
ASEH14KGTG	A zone	110	110	89	72
	B zone	110	110	83	67
	C zone	89	89	72	36

1-3. Dry operation

The rotation number of compressor shall change according to the temperature, set temperature, and room temperature variation which the room temperature sensor of the indoor unit has detected as shown in the table below.

Zone is defined by set temperature and room temperature.

- **Rotation number range of compressor**

Unit: rps

Model name	Outdoor temperature zone	Operating rotation number
ASEH07KGTG ASEH09KGTG	X zone	26
	J zone	16
	Y zone	0
ASEH12KGTG ASEH14KGTG	X zone	22
	J zone	16
	Y zone	0

- **Compressor control based on room temperature**

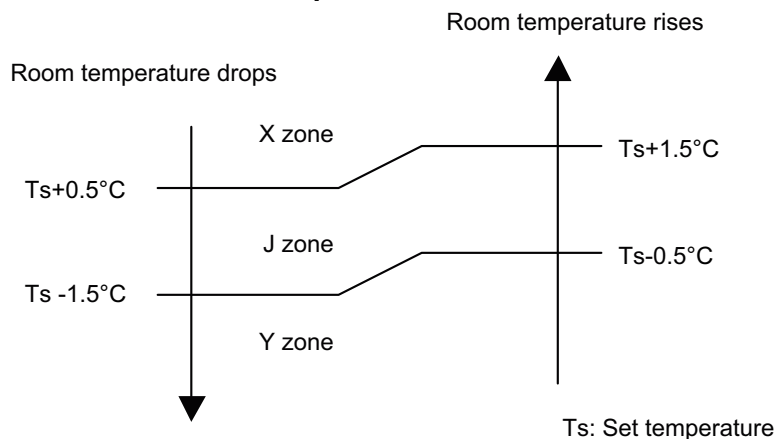

1-4. Rotation number of compressor at normal start-up

Rotation number of compressor soon after starting is controlled as below.

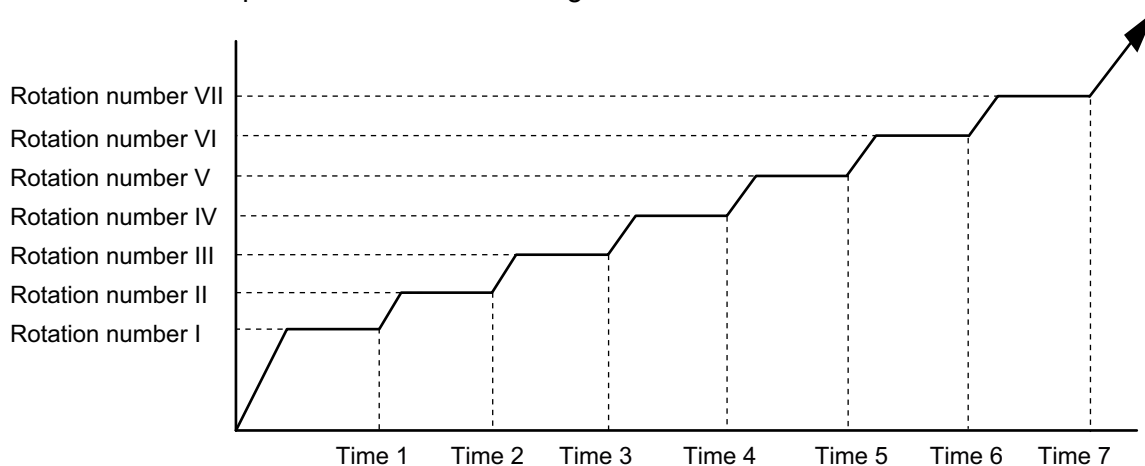

Rotation number (rps)	I	II	III	IV	V	VI	VII
	45	56	68	77	84	93	103
Time (sec)	1	2	3	4	5	6	7
	60	140	170	220	280	360	430

1-5. Limitation of compressor rotation number by outdoor temperature

The minimum rotation number of compressor is limited by outdoor temperature as below.

- **Cooling/Dry mode**

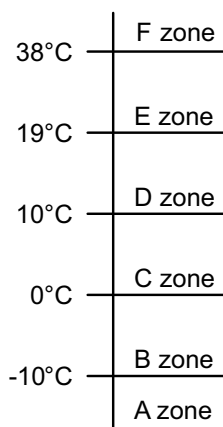

Unit: rps

Model name	Outdoor temperature zone	Limitation of compressor rotation number
AOEH07KGCG AOEH09KGCG	A zone	34
	B zone	34
	C zone	28
	D zone	1
	E zone	1
	F zone	20
AOEH12KGCG	A zone	36
	B zone	36
	C zone	28
	D zone	1
	E zone	1
	F zone	20
AOEH14KGCG	A zone	36
	B zone	36
	C zone	28
	D zone	20
	E zone	1
	F zone	20

- Heating mode

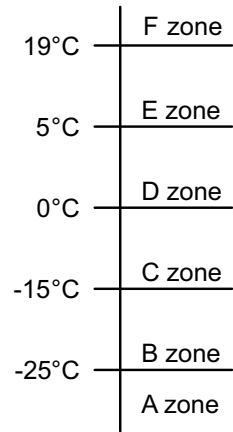

Unit: rps

Model name	Outdoor temperature zone	Limitation of compressor rotation number
AOEH07KGCG AOEH09KGCG	A zone	37
	B zone	37
	C zone	36
	D zone	15
	E zone	1
	F zone	1
AOEH12KGCG AOEH14KGCG	A zone	25
	B zone	25
	C zone	17
	D zone	10
	E zone	1
	F zone	1

2. Auto changeover operation

When the air conditioner is set to AUTO mode by remote controller, operation starts in the optimum mode from among heating, cooling, and monitoring modes. During operation, the optimum mode is automatically switched in accordance with temperature changes. The temperature can be set between 18°C and 30°C in 1.0°C steps.

- When operation starts, indoor fan and outdoor fan are operated for around 1 minute. Room temperature and outdoor temperature are sensed, and the operation mode is selected in accordance with the table below.

Room temperature	Operation mode
$Tr > Ts + 2^{\circ}\text{C}$	Cooling
$Ts + 2^{\circ}\text{C} \geq Tr \geq Ts - 2^{\circ}\text{C}$	Middle zone
$Tr < Ts - 2^{\circ}\text{C}$	Heating

Tr: Room temperature

Ts: Setting temperature

NOTE: When the operation mode is middle zone, indoor unit operation mode is selected as below.

- Same operation mode is selected as outdoor unit.
If outdoor unit is operating in cooling and heating mode, indoor unit will be operated by the same operation mode.
- Selected by outdoor temperature.
If outdoor unit is operating in other than cooling and heating mode, indoor unit will be operated according to the outdoor temperature as below.

Outdoor temp.	Operation mode
25°C or more	Cooling
Less than 25°C	Heating

- When the compressor was stopped for 6 consecutive minutes by temperature control function after the cooling or heating mode was selected as above, operation is switched to monitoring mode and the operation mode selection is done again.
- When the middle zone is selected on the predetermining of the operation mode, the operation mode before the changing to the monitoring mode is selected.

Operation flow chart

Ts: Setting temperature

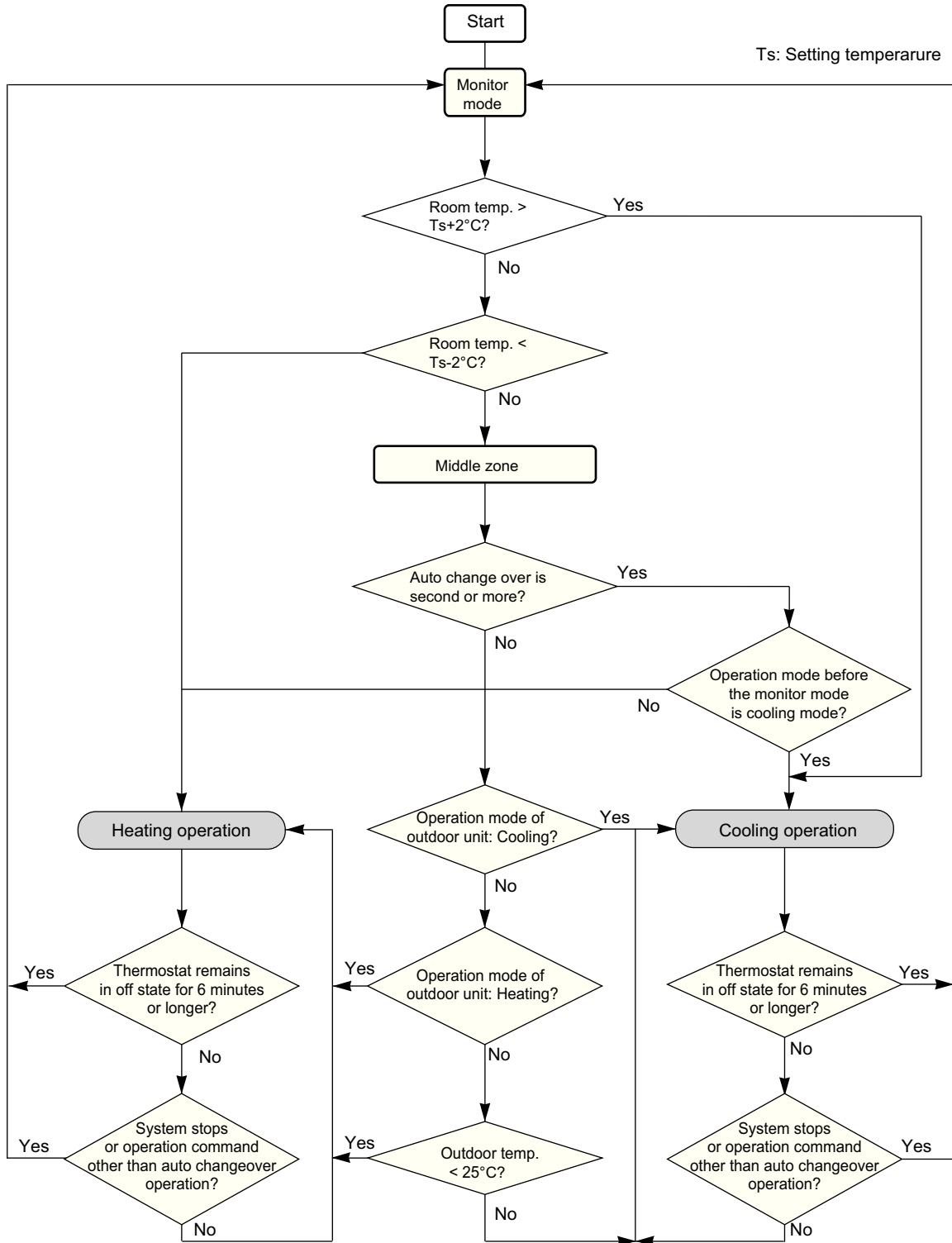

CONTROL AND FUNCTIONS

CONTROL AND FUNCTIONS

3. Fan control

Tr: Room temperature

Ts: Setting temperature

3-1. Indoor fan control

■ Fan speed

Indoor fan speed is defined as below.

Operation mode	Fan mode	Speed (rpm)			
		ASEH07KGTG	ASEH09KGTG	ASEH12KGTG	ASEH14KGTG
Heating	POWERFUL	1,200	1,230	1,290	1,330
	HIGH	990	1,020	1,220	1,260
	MED—HIGH	990	1,020	1,140	1,160
	MED	890	890	1,060	1,080
	MED—LOW	890	890	1,060	1,080
	LOW	790	790	900	900
	QUIET	580	580	630	670
	Cool air prevention	550	550	550	590
S-LOW	400	400	470	470	
Cooling/Fan	POWERFUL	1,110	1,170	1,200	1,290
	HIGH	950	1,030	1,130	1,220
	MED—HIGH	850	890	950	1,000
	MED	850	890	950	1,000
	MED—LOW	850	890	950	1,000
	LOW	750	750	790	810
	QUIET	550	550	550	590
	Soft quiet	470*1	470*1	490*1	510*1
S-LOW	400*2	400*2	470*2	470*2	
Dry		X zone: 550	X zone: 550	X zone: 550	X zone: 590
		J zone: 550	J zone: 550	J zone: 550	J zone: 590

*1: Fan mode only

*2: Cooling mode only

■ Fan operation

Airflow can be switched in 7 steps such as AUTO, QUIET, LOW, MED—LOW, MED, MED—HIGH, HIGH while indoor unit fan only runs.

When fan mode is set at AUTO, it operates on MED fan speed.

■ Cooling operation

Switch the airflow AUTO, and indoor fan motor will run according to room temperature, as below. On the other hand, if switched in HIGH—QUIET, indoor motor will run at a constant airflow of COOL operation modes QUIET, LOW, MED, HIGH as shown in “Fan speed” above.

Airflow change over (Cooling: Auto)

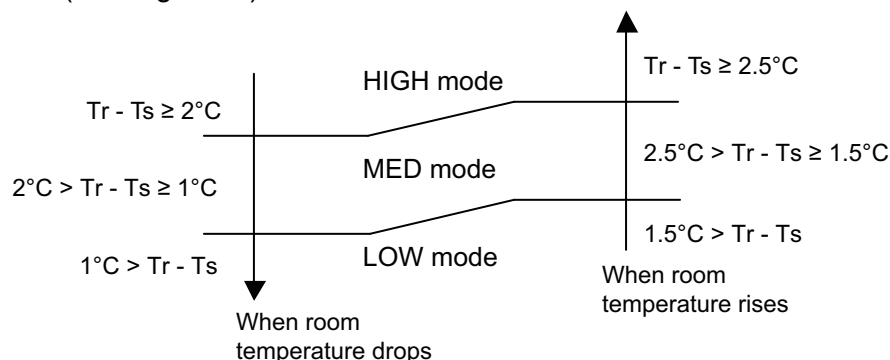

■ Dry operation

During dry operation, fan speed setting can not be changed as shown in “Fan speed” above.

■ Heating operation

Switch the airflow AUTO, and the indoor fan motor will run according to a room temperature, as below.

On the other hand, if switched in HIGH—QUIET, the indoor motor will run at a constant airflow of HEAT operation modes QUIET, LOW, MED, HIGH as shown in “Fan speed” above.

Airflow change over (Heating: Auto)

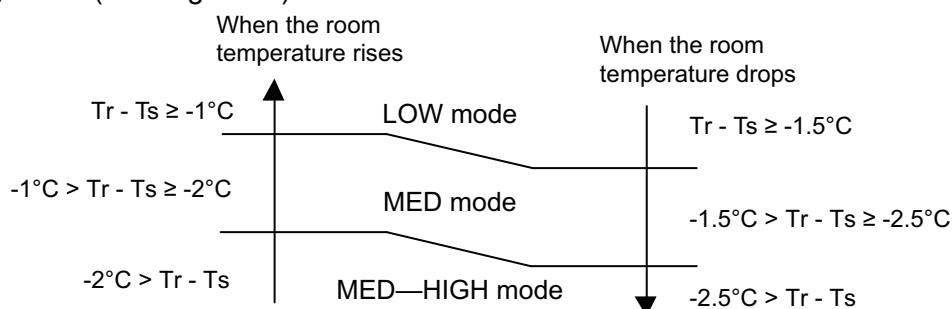

■ Cool air prevention control (heating mode)

The maximum value of the indoor fan speed is set as shown below, based on the detected temperature by the indoor heat exchanger sensor on heating mode.

- Normal operation

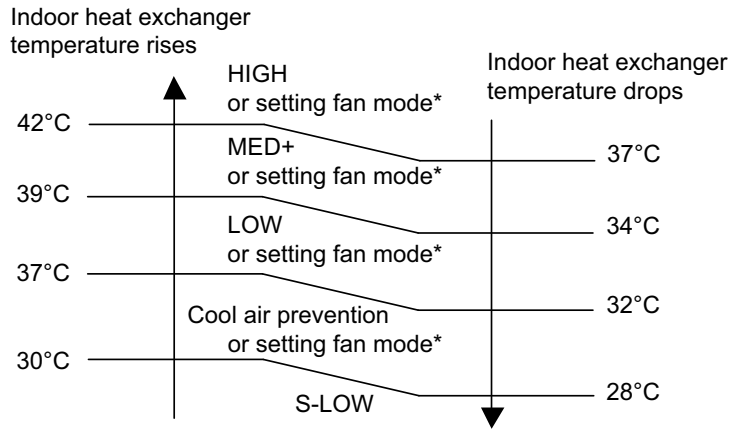

7 minutes later:

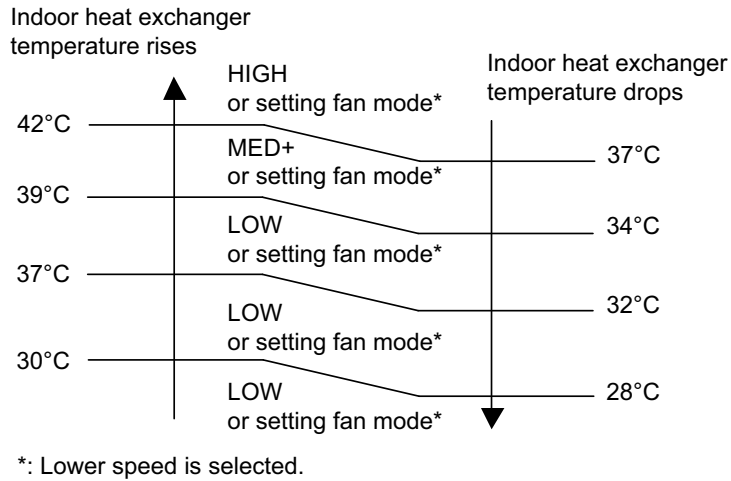

CONTROL AND FUNCTIONS

CONTROL AND FUNCTIONS

• **Powerful operation**

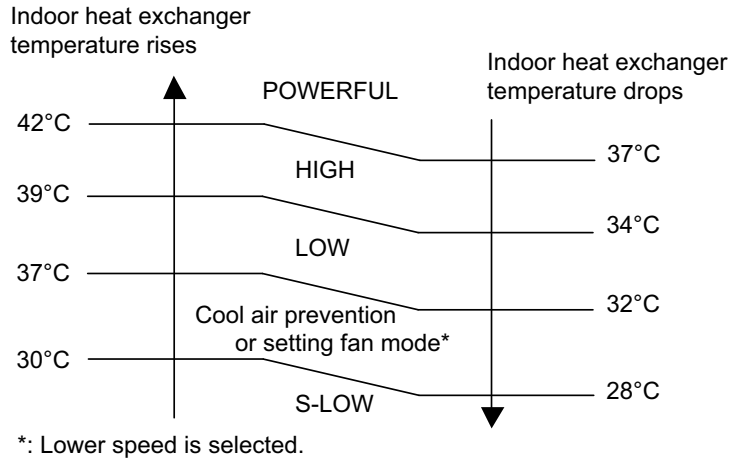

7 minutes later:

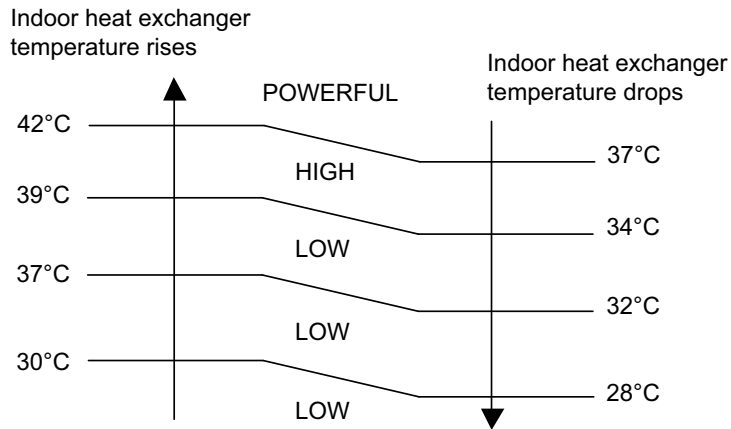

• **10 °C HEAT operation**

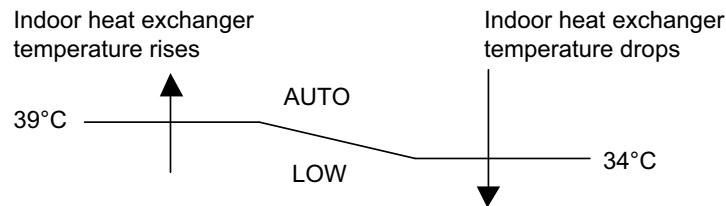

■ **Moisture return prevention control (cooling and dry mode)**

Switch the airflow AUTO at cooling mode, and the indoor fan motor will run as shown below.

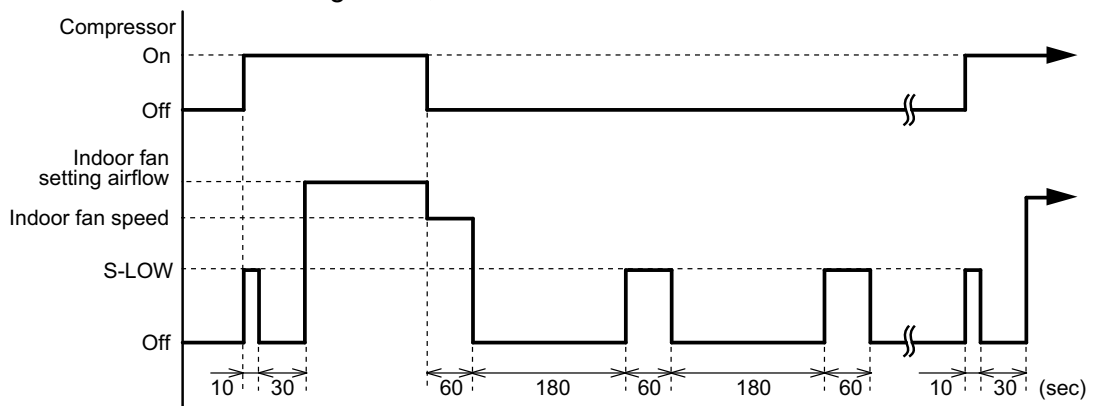

3-2. Outdoor fan control

■ Outdoor fan motor

This outdoor unit has a DC fan motor. (Control method is different between AC and DC motors.)

■ Fan speed

● Model: AOEH07KGCG

Fan speed is defined by outdoor temperature and rotation number of compressor.

• Outside air temperature zone selection

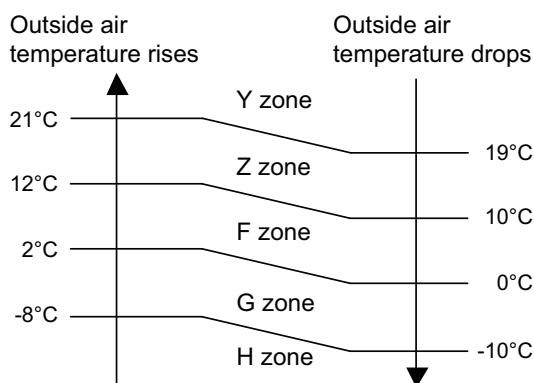

Unit: rpm

Fan step	Cooling	Heating	Dry	Cooling or dry at low outdoor temp.				
	Y zone		Y zone	Z zone	F zone	G zone	H zone	
S-HIGH2	—	980	—	—	—	—	—	—
S-HIGH1	990	980	—	—	—	—	—	—
HIGH	990	980	—	—	—	—	—	—
10	—	800	—	—	—	—	—	—
9	990	800	990	390	250	200	200	
8	800	800	800	390	250	200	200	
7	800	800	800	390	250	200	200	
6	800	740	800	390	250	200	200	
5	740	680	740	350	230	170	170	
4	700	620	700	330	210	170	170	
3	640	550	640	250	210	170	170	
2	550	500	550	200	210	170	170	
1	480	450	480	200	200	170	170	

NOTE: After defrost control on the heating mode, the fan speed is kept higher regardless of the rotation number of compressor.

Fan speed after defrost control: 980 rpm

● Model: AOEH09KGCG

Fan speed is defined by outdoor temperature and rotation number of compressor.

• Outside air temperature zone selection

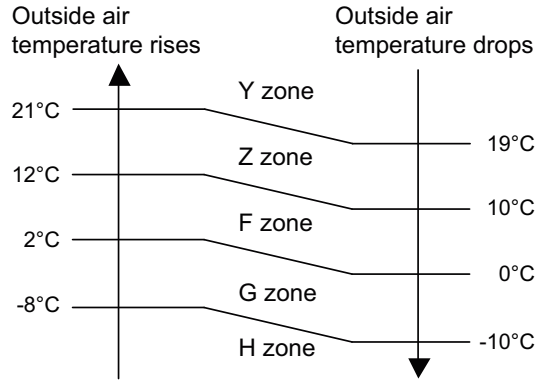

Unit: rpm

Fan step	Cooling	Heating	Dry	Cooling or dry at low outdoor temp.				
	Y zone		Y zone	Z zone	F zone	G zone	H zone	
S-HIGH2	—	980	—	—	—	—	—	—
S-HIGH1	990	980	—	—	—	—	—	—
HIGH	990	980	—	—	—	—	—	—
10	—	800	—	—	—	—	—	—
9	990	800	990	390	250	200	200	200
8	800	800	800	390	250	200	200	200
7	800	800	800	390	250	200	200	200
6	800	740	800	390	250	200	200	200
5	740	710	740	350	230	170	170	170
4	700	680	700	330	210	170	170	170
3	640	550	640	250	210	170	170	170
2	550	500	550	200	210	170	170	170
1	480	450	480	200	200	170	170	170

NOTE: After defrost control on the heating mode, the fan speed is kept higher regardless of the rotation number of compressor.

Fan speed after defrost control: 980 rpm

CONTROL AND FUNCTIONS

CONTROL AND FUNCTIONS

● Models: AOEH12KGCG and AOEH14KGCG

Fan speed is defined by outdoor temperature and rotation number of compressor.

• Outside air temperature zone selection

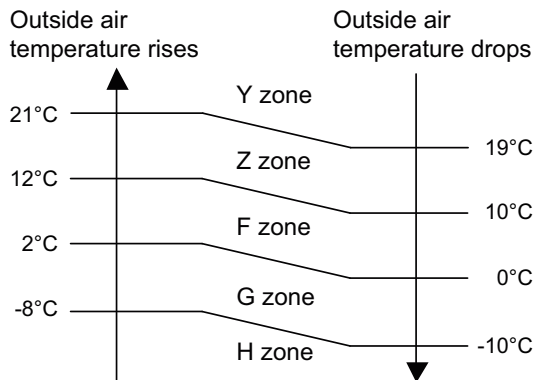

Unit: rpm

Fan step	Cooling	Heating	Dry	Cooling or dry at low outdoor temp.			
	Y zone		Y zone	Z zone	F zone	G zone	H zone
S-HIGH2	—	1,120	—	—	—	—	—
S-HIGH1	990	1,120	—	—	—	—	—
HIGH	990	1,120	—	—	—	—	—
10	—	870	—	—	—	—	—
9	990	870	990	990	990	990	990
8	920	870	780	630	300	280	280
7	920	870	780	630	300	280	280
6	920	710	780	630	300	280	280
5	920	660	760	610	270	250	250
4	810	660	630	450	240	220	220
3	670	500	490	310	220	200	200
2	570	500	390	200	220	200	200
1	520	500	360	200	200	200	200

NOTE: After defrost control on the heating mode, the fan speed is kept higher regardless of the rotation number of compressor.

Fan speed after defrost control: 1,120 rpm

4. Louver control

4-1. Horizontal louver control

Each time the button is pressed, the airflow direction range will change as below:

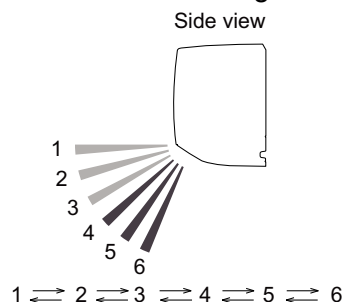

- Remote controller display is not changed.
- Up/down airflow direction is set automatically as shown, in accordance with the type of operation selected.

Cooling / Dry mode : Horizontal flow 1

Heating mode : Downward flow 6

- During AUTO operation, for the first a few minutes after beginning operation, airflow will be horizontal 1; the air direction cannot be adjusted during this period. The airflow direction setting will temporarily become 1 when the temperature of the airflow is low at the start of the Heating mode.
- After beginning of AUTO/HEAT mode operated and automatic defrosting operation, the airflow will be horizontal 1. However, the airflow direction cannot be adjusted at beginning AUTO operation mode.

4-2. Vertical louver adjustment

Move the vertical louvers to adjust airflow direction you prefer.

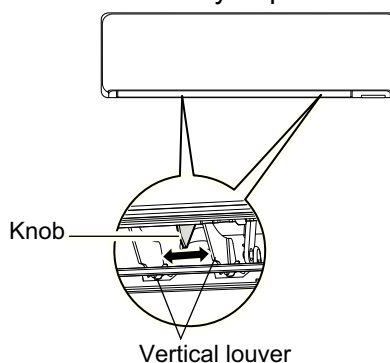

4-3. Swing operation

- To select up/down airflow swing operation
When the swing signal is received, the horizontal louver starts to swing.
 - Swinging range
 - Cooling mode/dry mode/fan mode (1 to 3): 1 ↔ 4
 - Heating mode/fan mode (4 to 6): 3 ↔ 6
 - When the indoor fan is S-LOW or stop mode, the swing operation is interrupted and it stops at either upper end or bottom end.

- To select left/right airflow swing operation
No function

5. Timer operation control

5-1. Wireless remote control

On/Off timer	Program timer	Sleep timer	Weekly timer
○	○	○	○

● On/Off timer

- Off timer: When the clock reaches the set timer, the air conditioner will be turned off.

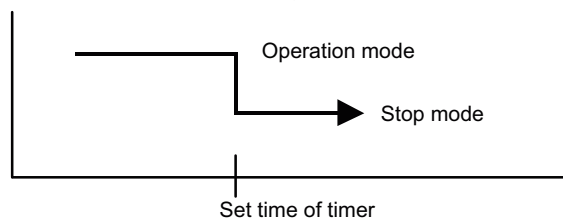

- On timer: When the clock reaches the set timer, the air conditioner will be turned on.

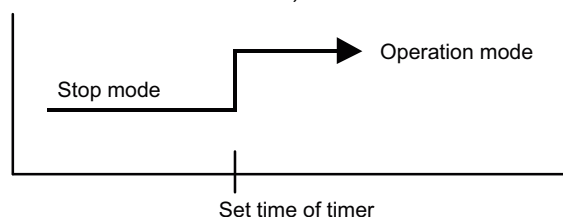

● Program timer

- The program timer allows the off timer and the on timer to be used in combination one time.

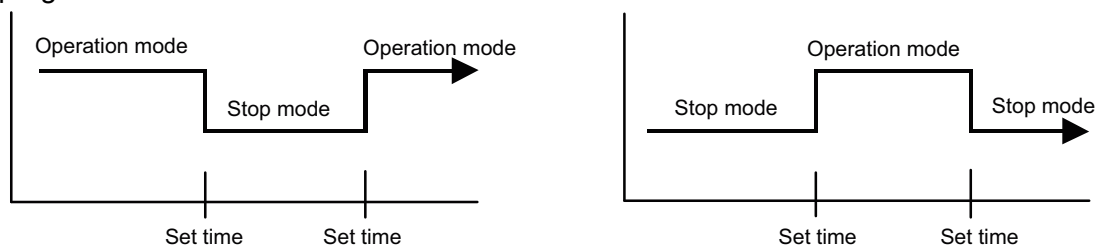

- Operation will start from the timer setting (either off timer and on timer) whichever is closest to the clock current timer setting. The order of operations is indicated by the allow in the remote controller screen.
- Sleep timer operation cannot be combined with on timer operation.

● Sleep timer

If the sleep timer is set, the room temperature is monitored and the operation is stopped automatically. If the operation mode or the set temperature is change after the sleep timer is set, the operation is continued according to the changed setting of the sleep timer from that time on.

- In the cooling operation mode

When the sleep timer is set, the setting temperature is increased 1°C. It increases the setting temperature another 1°C after 1 hour. After that, the setting temperature is not changed and the operation is stopped at the setting time.

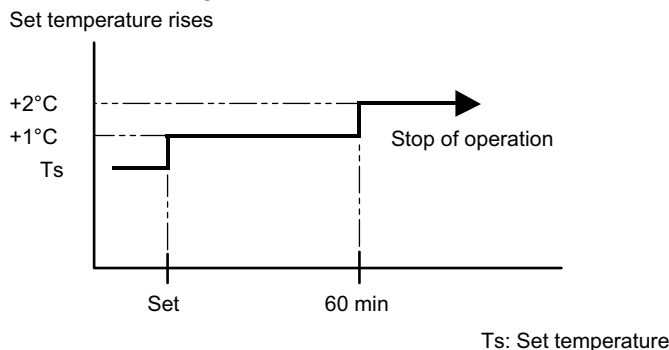

- In the heating operation mode

When the sleep timer is set, the setting temperature is decreased 1°C. It decreases the setting temperature another 1°C every 30 minutes. Upon lowering 4°C, the setting temperature is not changed and the operation is stopped at the setting time.

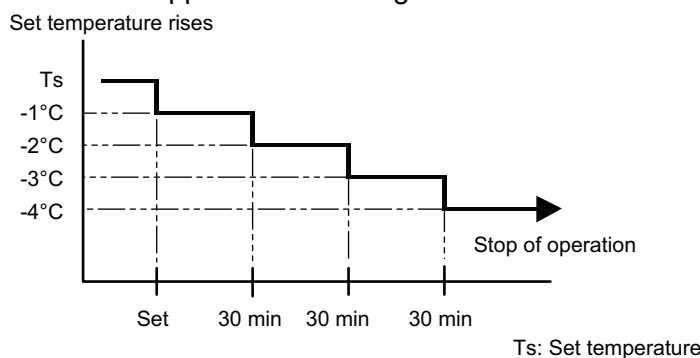

● Weekly timer

On and off timer can be combined, and up to 4 reservations per day and 28 reservations per week. Before setting the program, set the week and time of the air conditioner at first. If the week and time are not set, the weekly timer will not operate correctly at the setting time.

5-2. Wired remote control

On/Off timer	Program timer	Sleep timer	Weekly timer	Temperature Setback Timer
○	○	○	○	○

■ On/Off timer

- Off timer: When the clock reaches the set timer, the air conditioner will be turned off.

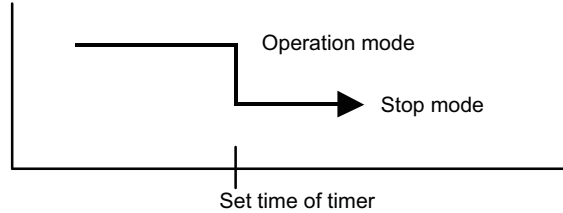

- On timer: When the clock reaches the set timer, the air conditioner will be turned on.

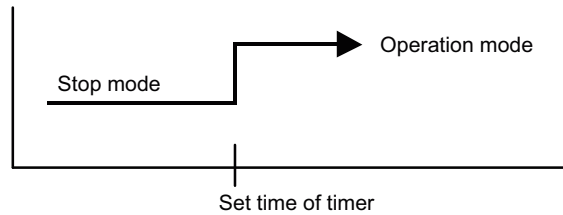

■ Program timer

- The program timer allows the off timer and the on timer to be used in combination one time.

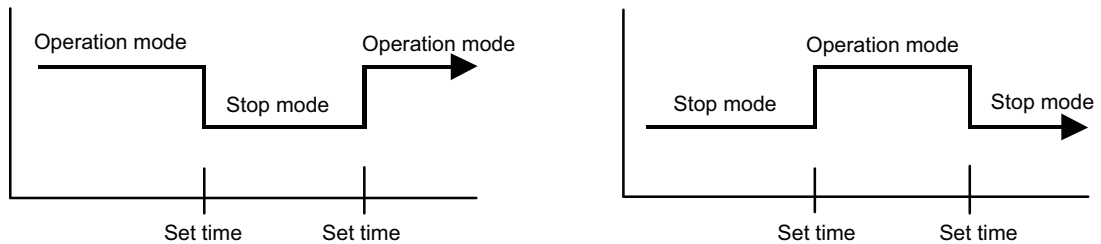

- Operation will start from the timer setting (either off timer and on timer) whichever is closest to the clock current timer setting. The order of operations is indicated by the allow in the remote controller screen.
- Sleep timer operation cannot be combined with on timer operation.

■ Sleep timer

If the sleep timer is set, the room temperature is monitored and the operation is stopped automatically. If the operation mode or the set temperature is change after the sleep timer is set, the operation is continued according to the changed setting of the sleep timer from that time on.

- In the cooling operation mode

When the sleep timer is set, the setting temperature is increased 1°C. It increases the setting temperature another 1°C after 1 hour. After that, the setting temperature is not changed and the operation is stopped at the setting time.

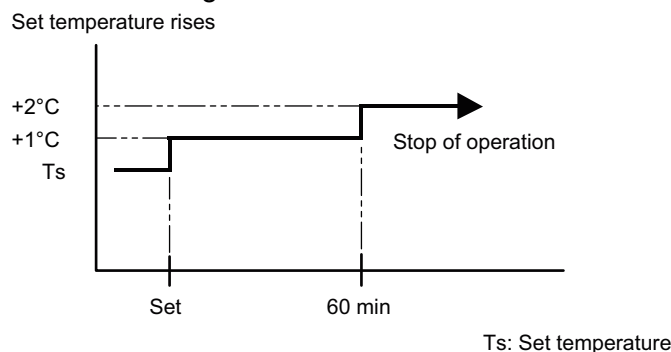

- In the heating operation mode

When the sleep timer is set, the setting temperature is decreased 1°C. It decreases the setting temperature another 1°C every 30 minutes. Upon lowering 4°C, the setting temperature is not changed and the operation is stopped at the setting time.

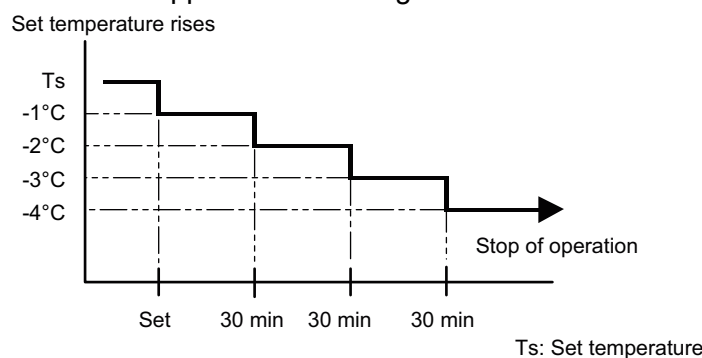

■ Weekly timer

On and off timer can be combined, and up to 4 reservations per day and 28 reservations per week. Before setting the program, set the week and time of the air conditioner at first. If the week and time are not set, the weekly timer will not operate correctly at the setting time.

■ Temperature Setback Timer

- The temperature setback timer only changes the set temperature for 7 days, it cannot be used to start or stop air conditioner operation.
- The temperature setback timer can be set to operate up to two times per day but only one temperature setting can be used.
- During COOLING/DRY mode, the air conditioner will operate at a minimum of 18°C even if the SET BACK temperature is set to 17°C or lower.

Case of Temperature Setback Timer on the Cooling operation. (Setting temperature :22°C, SET BACK temperature :26°C)

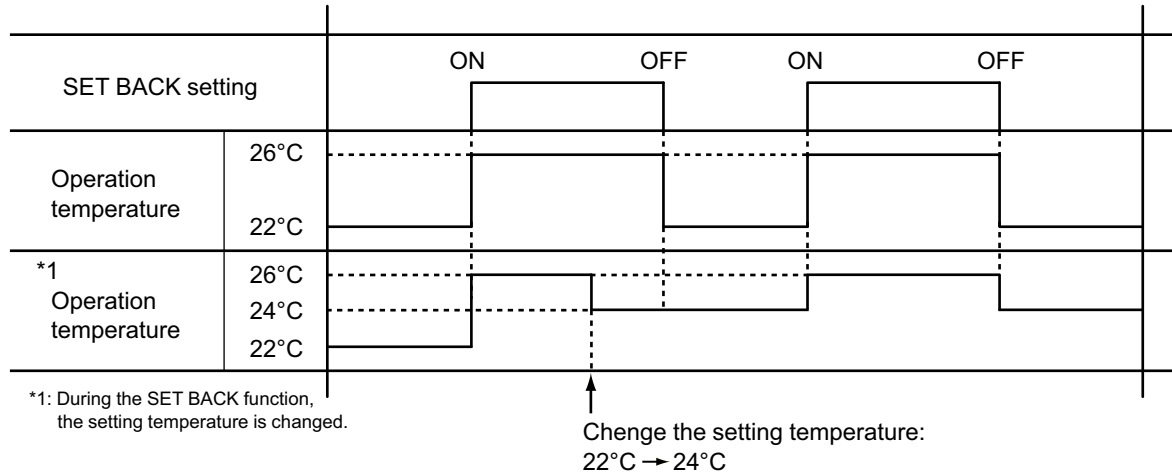

6. Defrost operation control

Tn: Outdoor unit heat exchanger temperature

Ta: Outdoor temperature

Tn10: Temperature at 10 minutes after compressor start

Tnb: Temperature before 5 minutes

• Triggering condition

The defrost operation starts when outdoor unit heat exchanger temperature sensor detects the temperature lower than the values shown below.

– 1st time defrosting after starting operation

Compressor integrating operation time	Less than 17 min.	17 to 57 min.	More than 57 min.
Condition	Does not operate	$T_n \leq -9^\circ\text{C}$ and $T_n - T_a \geq 5$ deg	$T_n \leq -5^\circ\text{C}$

– 2nd time and after

Compressor integrating operation time	Less than 40 min.	More than 40 min.	
Condition	Does not operate	$T_n - T_{n10} < -5$ deg ($T_n \leq -6^\circ\text{C}$) $T_n - T_{nb} < -2$ deg ($T_n \leq -6^\circ\text{C}$) $T_n \leq -17^\circ\text{C}$ ($T_a \geq -10^\circ\text{C}$) $T_n \leq T_a - 7^\circ\text{C}$ or $T_n \leq -20^\circ\text{C}$ ($T_a < -10^\circ\text{C}$)	

– Integrating defrost (Constant monitoring)

Compressor integrating operation time	More than 240 min. (For long continuous operation)	More than 215 min. (For long continuous operation)	Less than 10 min.* (For intermittent operation)
Condition	$T_n \leq -3^\circ\text{C}$	$T_n \leq -5^\circ\text{C}$	Count of the compressor off: 40 times

*: If the compressor continuous operation time is less than 10 minutes, the number of the compressor off is counted. If any defrost operated, the compressor off count is cleared.

• Release condition

The defrost operation is released when either one of the conditions below is satisfied.

Outdoor unit heat exchanger temperature (after 1 minute or later since compressor start)	16°C or more
Compressor operation time	15 minutes

6-1. Defrost operation in heating operation stopped

If the outdoor unit is frosted when stopping the heating operation, it stops after performing the automatic defrosting operation.

In this time, if the indoor unit operation lamp flashes slowly (6 sec on/2 sec off), the outdoor unit allow the heat exchanger to defrost, and then stop.

• Triggering condition

When all of the following conditions are satisfied in heating operation

- Compressor operation integrating time: 30 minutes or more
- Compressor continuous operation time: 10 minutes or more
- Outdoor unit heat exchanger temperature: -4°C or less

• Release condition

The defrost operation is released when either one of the conditions below is satisfied.

Outdoor unit heat exchanger temperature (after 1 minute or later since compressor start)	16°C or more
Compressor operation time	15 minutes

7. Various control

7-1. Auto restart

When the power was interrupted by a power failure etc. during operation, the operation contents at that time are memorized and when the power is recovered, operation is automatically started with the memorized operation contents.

Operation contents memorized when the power is interrupted
Operation mode
Setting temperature
Fan mode setting
Timer mode and set time (set by wireless remote controller)
Airflow direction setting
Swing
ECONOMY operation
10 °C HEAT operation
Outdoor low noise operation
Remote control setting
WLAN LED setting

7-2. MANUAL AUTO operation

When the wireless remote controller is lost or battery power dissipated, this function will work without the remote controller.

When MANUAL AUTO button is pressed more than 3 seconds and less than 10 seconds, MANUAL AUTO operation starts as shown in the table below. To stop operation, press the MANUAL AUTO button for 3 seconds.

Operation mode	Auto changeover
Fan mode	AUTO
Timer mode	Continuous (no timer setting available)
Setting temperature	24°C
Horizontal louver setting	Standard
SWING	Off
ECONOMY	Off
Human sensor	Off

7-3. Forced cooling operation

The outdoor unit may not operate depending on the room temperature.

When FORCED COOLING OPERATION button is pressed more than 10 seconds, forced cooling operation starts as shown in the table below.

Operation mode	Cooling
Fan mode	HIGH
Timer mode	Continuous (no timer setting available)
Setting temperature	24°C
Horizontal louver setting	Standard
Vertical louver setting	According to memory position
SWING	Off
ECONOMY	Off
Human sensor	Off

- During the forced cooling operation, it operates regardless of room temperature sensor.
- The operation indicator lamp and the timer indicator lamp blink simultaneously during the forced cooling operation.
They blink for 1 second ON and 1 second OFF on both the operation indicator lamp and the timer indicator lamp (same as test operation).

By performing one of the following action, test operation will be canceled:

- Pressing the remote controller START/STOP button
- Pressing FORCED COOLING OPERATION button for 3 seconds
- 60 minutes passed after starting forced cooling operation

NOTE: When HEAT operation is selected on the remote controller during forced cooling operation, heating test run will begin in about 3 minutes.

7-4. 10 °C HEAT operation

10 °C HEAT operation performs as below setting when pressing 10 °C HEAT button.

Operation mode	Heating
Setting temperature	10°C
Fan mode	AUTO
LED display	Economy
Defrost operation	Operate as normal

7-5. ECONOMY operation

The ECONOMY operation starts by pressing ECONOMY button on the remote controller.

The ECONOMY operation is almost the same operation as below settings.

Mode	Cooling/Dry	Heating
Target temperature	Setting temperature +1°C	Setting temperature -1°C

7-6. POWERFUL operation

The POWERFUL operation starts by pressing POWERFUL button on the remote controller. The indoor unit and outdoor unit operate at maximum power as shown in the table below.

Rotation number of compressor		Maximum
Fan mode		POWERFUL
Vertical airflow direction louver setting	Cooling	3
	Dry	
	Heating	6

Release condition:

- Cooling/Dry
Room temperature \leq Setting temperature -0.5°C or Operation time has passed 20 minutes.
- Heating
Room temperature \geq Setting temperature $+0.5^{\circ}\text{C}$ or Operation time has passed 20 minutes.

7-7. Fresh air control

The fan motor for Fresh Air is operated in synchronization with the indoor fan operation as below.

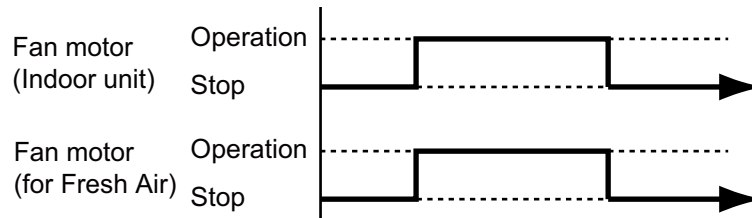

7-8. Compressor preheating operation

Compressor preheating operation prevents the damage caused by the refrigerant in the compressor from soaking into the oil. By preheating the compressor, warm airflow is quickly discharged when the operation is started.

- **Triggering condition**
 - 30 minutes after compressor stopped.
 - Outdoor unit heat exchanger temperature (T_n)

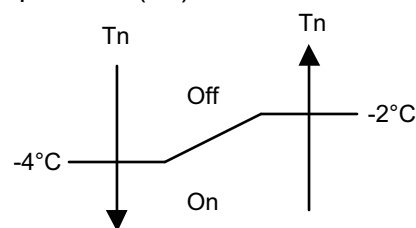

When the jumper wire (J600) is disconnected:

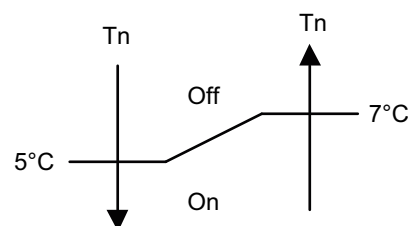

7-9. External electrical heater control

The external electrical heater is operated as below.

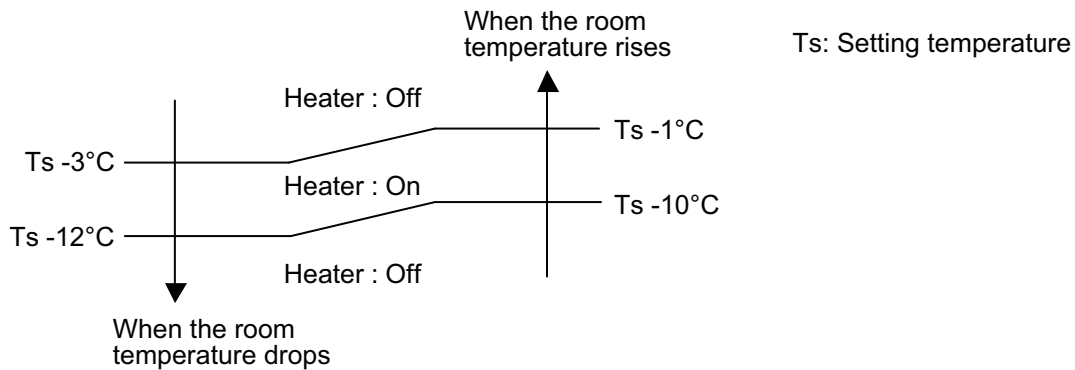

NOTES:

- When the compressor stop, external electric heater is off.
- It operates only in heating mode and when the indoor fan operates. (However, S-LOW is excluded.)

7-10. Electronic expansion valve control

The most proper opening of the electronic expansion valve is calculated and controlled under the present operating condition based on the table below.

Operation mode	Pulse range
Cooling/dry mode	Between 52 and 480 pulses
Heating mode	

NOTE: At the time of supplying the power to the outdoor unit, the initialization of the electronic expansion valve is operated (528 pulses are input to the closing direction).

7-11. Prevention to restart for 3 minutes (3 minutes st)

When the compressor fails to start for the number of times below, it does not enter operation status for 3 minutes.

Retry number	50
Retry set number	3

When the compressor fails to start in the retry set number above, the compressor is stopped.

7-12. 4-way valve control

- If heating mode is selected at the compressor start, 4-way valve is energized for heating.
- When the air conditioner is switched between cooling and heating mode, compressor is stopped, and the 4-way valve is switched when the 3 minutes passes and the compressor is started.

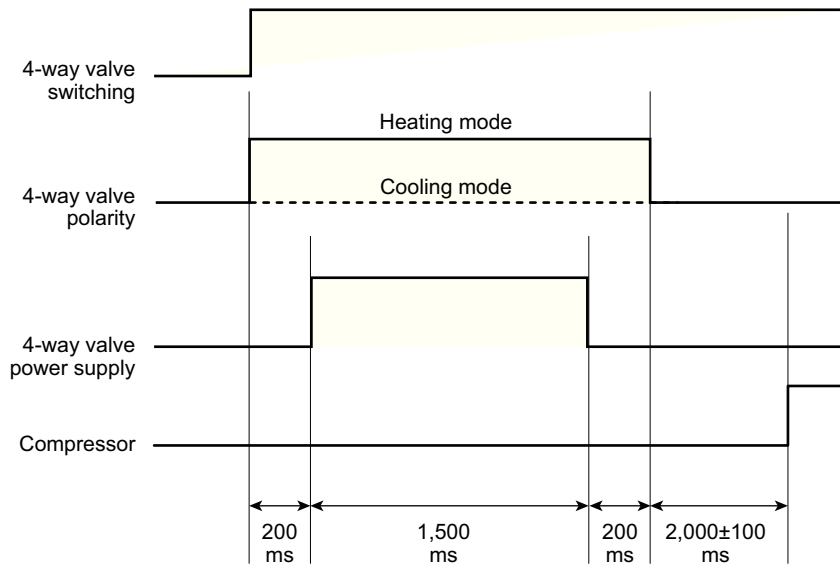

7-13. Human sensor for energy saving

If no one enters the room for approximately 20 minutes, the set temperature is automatically controlled. (When someone comes back into the room, the human sensor detect this, and automatically revert to the original settings.)

Operation mode	Operation details (If there is no one in the room for a while)
Cool/Dry	The setting temperature is increased by maximum 2°C. (Maximum setting temperature: 30°C)
Heat	The setting temperature is decreased by maximum 4°C. (Minimum setting temperature: 16°C)
Auto	Energy saving function is performed automatically for the selected mode (cool/heat/dry).

- Application range:

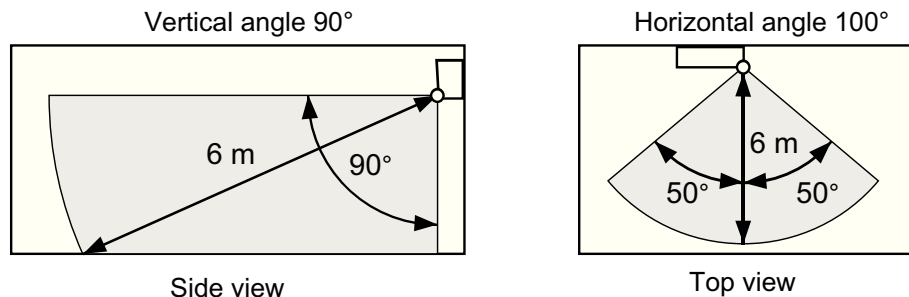

Energy saving function may not work when the room temperature is very different from the temperature defined in the temperature setting, such as when immediately after starting the operation.

- Details about detection with the human sensor:
The human sensor detects whether there are people in the room by looking for movement by people in the room.

7-14. Outdoor unit low noise operation

The outdoor unit low noise operation functions by OUTDOOR UNIT LOW NOISE button on the remote controller.

This operation stops the PFC control, and changes the current value.

Operation mode	Current	
	Trigger condition	Release condition
Cooling/Dry mode	1.9 A	1.4 A
Heating mode		

7-15. Unit status monitoring and the detected value indication

The wired remote controller can monitor the indoor and outdoor units' status and display the detected result as a relevant ID.

For details of the display method, refer to the Chapter of "Display Sensor Values" in the *Installation Manual* of Wired Remote Controller (Touch Panel).

The status can be monitored and displayed on the wired remote controller by assigning an arbitrary ID. For available ID list, refer to the table below.

NOTE: Operating time for each part cannot be reset when the part is replaced. Take notes of the operating time before replacing to count the operating time of the replaced part.

Available Sensor ID			
Sensor ID	Item	Unit	Remarks
00: Indoor unit			
00	000	Suction temp.	01: °C or °F
00	001	Room temp.	01: °C or °F When the wired remote controller thermistor is enabled, temperature of the wired remote controller thermistor is displayed.
00	002	Wired remote controller detected temp.	01: °C or °F
00	006	Heat exchanger middle temp.	01: °C or °F
00	020	Fan rotation number	03: rpm
00	080	Indoor unit total energized hours	11: h
00	081	Total filtering hours	11: h
00	082	Indoor unit fan total operation hours	11: h
00	095	Presence or absence detected by human sensor	00: — 0: Absence, 1: Presence —: Human sensor error or No human sensor
00	140	Operation or Stop (External input)	00: — 0: Off, 1: On —: When the function setting 46 is not set NOTE: Available only for external input port of the indoor unit
00	142	Forced stop (External input)	00: — 0: Off, 1: On —: When the function setting 46 is not set NOTE: Available only for external input port of the indoor unit
00	143	Operation or Stop 2 (External input)	00: — 0: Off, 1: On —: When the function setting 46 is not set NOTE: Available only for external input port of the indoor unit

Available Sensor ID				
Sensor ID		Item	Unit	Remarks
00	155	Operation or Stop On/Off (External output)	00: —	0: Off, 1: On NOTE: The value is output even if the function setting or rotary switch is not set.
00	156	Error On/Off (External output)	00: —	0: Off, 1: On NOTE: The value is output even if the function setting or rotary switch is not set.
00	157	Indoor unit fan interlocking On/Off (External output)	00: —	0: Off, 1: On NOTE: The value is output even if the function setting or rotary switch is not set.
00	158	Cooling thermostat On/Off (External output)	00: —	0: Off, 1: On NOTE: The value is output even if the function setting or rotary switch is not set.
00	159	Requested cooling strength On/Off (External output)	00: —	0: Off, 1: On NOTE: The value is output even if the function setting or rotary switch is not set.
00	160	External heater On/Off (External output)	00: —	0: Off, 1: On NOTE: The value is output even if the function setting or rotary switch is not set.
00	161	Heating operation status (External output)	00: —	0: Off, 1: On NOTE: The value is output even if the function setting or rotary switch is not set.
00	162	External output command by remote controller (External output)	00: —	0: Off, 1: On NOTE: The value is output even if the function setting or rotary switch is not set.
01: Outdoor unit				
01	000	Outdoor temp.	01: °C or °F	
01	001	Discharge temp.	01: °C or °F	
01	004	Heat exchanger outlet temp.	01: °C or °F	
01	007	Compressor temp.	01: °C or °F	
01	050	Fan 1 rotation number	03: rpm	
01	055	Compressor rotation number	04: rps	
01	060	Expansion valve (Upstream during heating)	05: pls	
01	080	4-way valve output status	07: Cooling/ Heating	0: Cooling, 1: Heating
01	100	Operating current	09: A	
01	110	Outdoor unit total power-on hours	11: h	
01	111	Compressor total heating operation hours	11: h	
01	112	Compressor total cooling operation hours	11: h	
01	113	Compressor total operation hours	11: h	
01	114	Outdoor unit fan 1 total operation hours	11: h	

8. Various protections

8-1. Discharge gas temperature over-rise prevention control

The discharge gas temperature sensor (discharge thermistor: outdoor unit side) detects the discharge gas temperature.

- When the discharge temperature becomes higher than the trigger condition, the rotation number of compressor is decreased as the table below, and it continues to decrease until the discharge temperature becomes lower than the trigger condition.
- When the discharge temperature becomes lower than the release condition, control of compressor rotation number is released.
- When the discharge temperature becomes higher than the compressor protection temperature, the compressor is stopped and the indoor unit indicator lamp starts blinking.

Trigger condition	104°C
Rotation number of compressor	-20 rps/120 seconds
Release condition	101°C
Compressor protection temperature	110°C

8-2. Anti-freezing control (cooling and dry mode)

The rotation number of compressor is decrease in cooling and dry mode when the indoor unit heat exchanger temperature sensor detects the temperature lower than the trigger condition.

When the indoor unit heat exchanger temperature reaches release condition, the anti-freezing control is stopped.

Trigger condition	4°C	
Release condition	Outdoor temp. $\geq 10^{\circ}\text{C}^{*1}$	7°C
	Outdoor temp. $\geq 12^{\circ}\text{C}^{*2}$	
	Outdoor temp. $< 10^{\circ}\text{C}^{*1}$	13°C
	Outdoor temp. $< 12^{\circ}\text{C}^{*2}$	

*1: During the outdoor temperature dropping

*2: During the outdoor temperature rising

8-3. Current release control

The rotation number of compressor is controlled so that the outdoor unit input current does not exceeds current limit value set according to the outdoor temperature.

The rotation number of compressor returns according to the operation mode, when the current becomes lower than the release value.

■ Models: AOEH07KGCG, AOEH09KGCG, and AOEH12KGCG

Operation mode	Outdoor temp. (Ta)	Trigger condition	Release condition
Cooling	$50^{\circ}\text{C} \leq \text{Ta}$	4.0 A	3.5 A
	$46^{\circ}\text{C} \leq \text{Ta} < 50^{\circ}\text{C}$	4.0 A	3.5 A
	$40^{\circ}\text{C} \leq \text{Ta} < 46^{\circ}\text{C}$	5.0 A	4.5 A
	$12^{\circ}\text{C} \leq \text{Ta} < 40^{\circ}\text{C}$	6.0 A	5.5 A
	$2^{\circ}\text{C} \leq \text{Ta} < 12^{\circ}\text{C}$	6.0 A	5.5 A
	$\text{Ta} < 2^{\circ}\text{C}$	6.0 A	5.5 A
Heating	$17^{\circ}\text{C} \leq \text{Ta}$	5.5 A	5.0 A
	$12^{\circ}\text{C} \leq \text{Ta} < 17^{\circ}\text{C}$	7.0 A	6.5 A
	$5^{\circ}\text{C} \leq \text{Ta} < 12^{\circ}\text{C}$	8.5 A	8.0 A
	$\text{Ta} < 5^{\circ}\text{C}$	8.5 A	8.0 A

■ Model: AOEH14KGCG

Operation mode	Outdoor temp. (Ta)	Trigger condition	Release condition
Cooling	$50^{\circ}\text{C} \leq \text{Ta}$	4.5 A	4.0 A
	$46^{\circ}\text{C} \leq \text{Ta} < 50^{\circ}\text{C}$	4.5 A	4.0 A
	$40^{\circ}\text{C} \leq \text{Ta} < 46^{\circ}\text{C}$	6.0 A	5.5 A
	$12^{\circ}\text{C} \leq \text{Ta} < 40^{\circ}\text{C}$	8.5 A	8.0 A
	$2^{\circ}\text{C} \leq \text{Ta} < 12^{\circ}\text{C}$	8.5 A	8.0 A
	$\text{Ta} < 2^{\circ}\text{C}$	8.5 A	8.0 A
Heating	$17^{\circ}\text{C} \leq \text{Ta}$	7.0 A	6.5 A
	$12^{\circ}\text{C} \leq \text{Ta} < 17^{\circ}\text{C}$	9.0 A	8.5 A
	$5^{\circ}\text{C} \leq \text{Ta} < 12^{\circ}\text{C}$	10.0 A	9.5 A
	$\text{Ta} < 5^{\circ}\text{C}$	10.0 A	9.5 A

8-4. Cooling pressure over-rise protection

When the outdoor unit heat exchanger temperature reaches trigger condition below, the compressor is stopped and trouble display is performed.

Trigger condition	65°C
-------------------	------

8-5. Low outdoor temperature protection

When the outdoor temperature sensor detects lower than the trigger condition below, the compressor is stopped.

Operation mode	Cooling/Dry
Trigger condition	-15°C
Release condition	-10°C

8-6. High temperature and high pressure release control

The compressor is controlled as follows.

- Heating mode

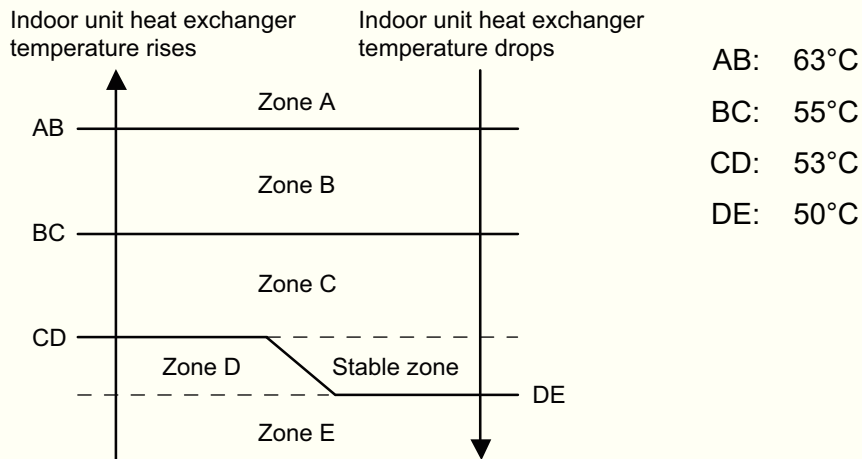

Zone	Operation	
Zone A	Compressor is stopped.	
Zone B	The rotation number of compressor is decreased.	-25 rps/120 sec.
Zone C		-3 rps/60 sec.
Zone D	The protection is released and the operation is returned to normal mode.	
Zone E		

5. FIELD WORKING

CONTENTS

5. FIELD WORKING

1. Function settings	05-1
1-1. Function settings by using remote controller	05-1
1-2. Custom code setting for wireless remote controller	05-7
2. External input and output	05-8
2-1. External input.....	05-9
2-2. External output	05-12
2-3. Setting of external input and output	05-14
2-4. Details of control input function.....	05-15
2-5. Details of control output function	05-19

1. Function settings

To adjust the functions of this product according to the installation environment, various types of function settings are available.

NOTE: Incorrect settings can cause a product malfunction.

1-1. Function settings by using remote controller

Some function settings can be changed on the remote controller. After confirming the setting procedure and the content of each function setting, select appropriate functions for your installation environment.

■ Setting procedure by using wireless remote controller

The function number and the associated setting value are displayed on the LCD of the remote controller. Follow the instructions written in the local setup procedure supplied with the remote controller, and select appropriate setting according to the installation environment.

Before connecting the power supply of the indoor unit, reconfirm following items:

- Cover for the electrical enclosure on the outdoor unit is in place.
- There is no wiring mistake.
- Piping air tightness test and vacuuming have been performed firmly.
- All the necessary wiring work for outdoor unit has been finished.

After reconfirming the items listed above, connect the power supply of the indoor unit.

NOTES:

- Settings will not be changed if invalid numbers or setting values are selected.
- When optional wired remote controller is used, refer to the installation manual enclosed with the remote controller.

Entering function setting mode:

While pressing the POWERFUL button and TEMP. (^) button simultaneously, press the RESET button to enter the function setting mode.

Selecting the function number and setting value:

1. Press the TEMP. (^) (v) buttons to select the function number. To switch between the left and right digits, press the 10 °C HEAT button.
2. Press the POWERFUL button to proceed to value setting. To return the function number selection, press the POWERFUL button again.
3. Press the TEMP. (^) (v) buttons to select the setting value. To switch between the left and right digits, press the 10 °C HEAT button.
4. Press the MODE button once. Confirm that you hear the beep.
5. Press the START/STOP button to fix the function setting. Confirm that you hear the beep.
6. Press the RESET button to end the function setting mode.
7. After completing the function setting, be sure to disconnect the power supply and then reconnect it.

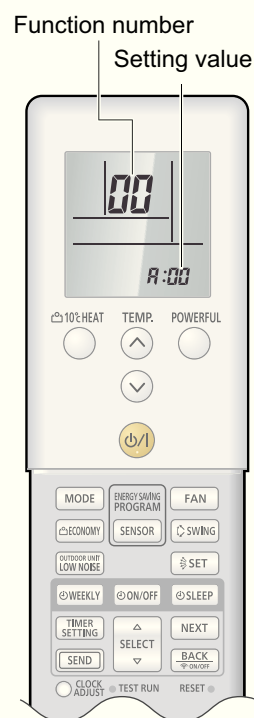

⚠ CAUTION

After disconnecting the power supply, wait 30 seconds or more before reconnecting it. The function setting will not become active unless the power supply is disconnected and then reconnected.

NOTES:

- The air conditioner custom code is set to \overline{F} prior to shipment.
- If you do not know the air conditioner custom code setting, try each of the custom codes ($\overline{F} \rightarrow \overline{b}$ $\rightarrow \overline{c} \rightarrow \overline{d}$) until you find the code that operates the air conditioner.

■ Contents of function setting

Each function setting listed in this section is adjustable in accordance with the installation environment.

NOTE: Setting will not be changed if invalid numbers or setting values are selected.

● Function setting list

	Function no.	Functions
1)	11	Filter sign
2)	30/31	Room temperature control for indoor unit sensor
3)	35/36	Room temperature control for wired remote controller sensor
4)	40	Auto restart
5)	42	Room temperature sensor switching
6)	44	Remote controller custom code
7)	46	External input control
8)	48	Room temperature sensor switching (Aux.)
9)	49	Indoor unit fan control for energy saving for cooling
10)	60	Switching functions for external output terminal

1) Filter sign

Select appropriate intervals for displaying the filter sign on the indoor unit according to the estimated amount of dust in the air of the room.

If the indication is not required, select "No indication" (03).

Function number	Setting value	Setting description	Factory setting
11	00	Standard (400 hours)	
	01	Long interval (1,000 hours)	
	02	Short interval (200 hours)	
	03	No indication	◆

2) Room temperature control for indoor unit sensor

Depending on the installed environment, correction of the room temperature sensor may be required. Select the appropriate control setting according to the installed environment.

The temperature of the room temperature sensor is corrected as follows:

Corrected temp. = Temp. of the room temp. sensor - Correction temp. value

Example of correction:

When the temperature of the room temp. sensor is 26°C and the setting value is "03" (-1.0°C), corrected temp. will be 27°C (26°C - [-1.0°C]).

The temperature correction values show the difference from the Standard setting "00" (manufacturer's recommended value).

Function number		Setting value	Setting description	Factory setting	
30 (For cooling)	31 (For heating)	00	Standard setting	◆	
		01	No correction 0.0°C		
		02	-0.5°C	More cooling Less heating	
		03	-1.0°C		
		04	-1.5°C		
		05	-2.0°C		
		06	-2.5°C		
		07	-3.0°C		
		08	-3.5°C		
		09	-4.0°C		
		10	+0.5°C	Less cooling More heating	
		11	+1.0°C		
		12	+1.5°C		
		13	+2.0°C		
		14	+2.5°C		
		15	+3.0°C		
		16	+3.5°C		
17	+4.0°C				

3) Room temperature control for wired remote controller sensor

Depending on the installed environment, correction of the wire remote temperature sensor may be required. Select the appropriate control setting according to the installed environment.

To change this setting, set Function 42 to Both "01".

Ensure that the Thermo Sensor icon is displayed on the remote controller screen.

Function number		Setting value	Setting description	Factory setting	
35 (For cooling)	36 (For heating)	00	Standard setting	◆	
		01	No correction 0.0°C		
		02	-0.5°C	More cooling Less heating	
		03	-1.0°C		
		04	-1.5°C		
		05	-2.0°C		
		06	-2.5°C		
		07	-3.0°C		
		08	-3.5°C		
		09	-4.0°C		
		10	+0.5°C	Less cooling More heating	
		11	+1.0°C		
		12	+1.5°C		
		13	+2.0°C		
		14	+2.5°C		
		15	+3.0°C		
		16	+3.5°C		
17	+4.0°C				

4) Auto restart

Enables or disables automatic restart after a power interruption.

Function number	Setting value	Setting description	Factory setting
40	00	Enable	◆
	01	Disable	

NOTE: Auto restart is an emergency function such as for power outage etc. Do not attempt to use this function in normal operation. Be sure to operate the unit by remote controller or external device.

5) Room temperature sensor switching

(Only for wired remote controller)

When using the wired remote controller temperature sensor, change the setting to "Both" (01).

Function number	Setting value	Setting description	Factory setting
42	00	Indoor unit	◆
	01	Both	

00: Sensor on the indoor unit is active.

01: Sensors on both indoor unit and wired remote controller are active.

NOTE: Remote controller sensor must be turned on by using the remote controller.

6) Remote controller custom code

(Only for wireless remote controller)

The indoor unit custom code can be changed. Select the appropriate custom code.

Function number	Setting value	Setting description	Factory setting
44	00	A	◆
	01	B	
	02	C	
	03	D	

7) External input control

“Operation/Stop” mode or “Forced stop” mode can be selected.

Function number	Setting value	Setting description	Factory setting
46	00	Operation/Stop mode 1 (Remote controller enabled)	◆
	01	(Setting prohibited)	
	02	Forced stop mode	
	03	Operation/Stop mode 2 (Remote controller disabled)	

8) Room temperature sensor switching (Aux.)

To use the temperature sensor on the wired remote controller only, change the setting to “Wired remote controller” (01).

This function will only work if the function setting 42 is set at “Both” (01).

When the setting value is set to “Both” (00), more suitable control of the room temperature is possible by setting function setting 30 and 31 too.

Function number	Setting value	Setting description	Factory setting
48	00	Both	◆
	01	Wired remote controller	

9) Indoor unit fan control for energy saving for cooling

Enables or disables the power-saving function by controlling the indoor unit fan rotation when the outdoor unit is stopped during cooling operation.

Function number	Setting value	Setting description	Factory setting
49	00	Disable	
	01	Enable	
	02	Remote controller	◆

00: When the outdoor unit is stopped, the indoor unit fan operates continuously following the setting on the remote controller.

01: When the outdoor unit is stopped, the indoor unit fan operates intermittently at a very low speed.

02: Enable or disable this function by remote controller setting.

NOTE: Set to “00” or “01” when connecting a remote controller that cannot set the Fan control for energy saving function or connecting a network converter. To confirm if the remote controller has this setting, refer to the operating manual of each remote controller.

10) Switching functions for external output terminal

Functions of the external output terminal can be switched. For details, refer to “External input and output”.

Function number	Setting value	Setting description	Factory setting
60	00	Operation status	◆
	01—08	(Setting prohibited)	
	09	Error status	
	10	Indoor unit fan operation status	
	11	(Setting prohibited)	

1-2. Custom code setting for wireless remote controller

To interconnect the air conditioner and the wireless remote controller, assignment of the custom code for the wireless remote controller is required.

NOTE: Air conditioner cannot receive a signal if the air conditioner has not been set for the custom code.

When 2 or more air conditioners are installed in a room, and the remote controller is operating an air conditioner other than the one you wish to set, change the custom code of the remote controller to operate only the air conditioner you wish to set. (4 selections possible.)

Confirm the setting of the remote controller custom code and the function setting. If these do not match, the remote controller cannot be used to operate for the air conditioner.

1. Press the START/STOP button until only the clock is displayed on the remote controller display.
2. Press the MODE button for at least 5 seconds to display the current custom code. (Initially set to \overline{A} .)
3. Press the TEMP. (\wedge) (\vee) buttons to change the custom code between $\overline{A} \rightarrow \overline{B} \rightarrow \overline{C} \rightarrow \overline{D}$. Match the code on the display to the air conditioner custom code. (Initially set to \overline{A} .)
4. Press the MODE button again to return to the clock display. The custom code will be changed.



NOTES:

- If no button is pressed within 30 seconds after the custom code is displayed, the system returns to the original clock indicator. In this case, start again from step 1.
- The air conditioner custom code is set to \overline{A} prior to shipment. To change the custom code, contact your retailer.
- If you do not know the assigned code for the air conditioner, try each of the custom code ($\overline{A} \rightarrow \overline{B} \rightarrow \overline{C} \rightarrow \overline{D}$) until you find the code which operates the air conditioner.

2. External input and output

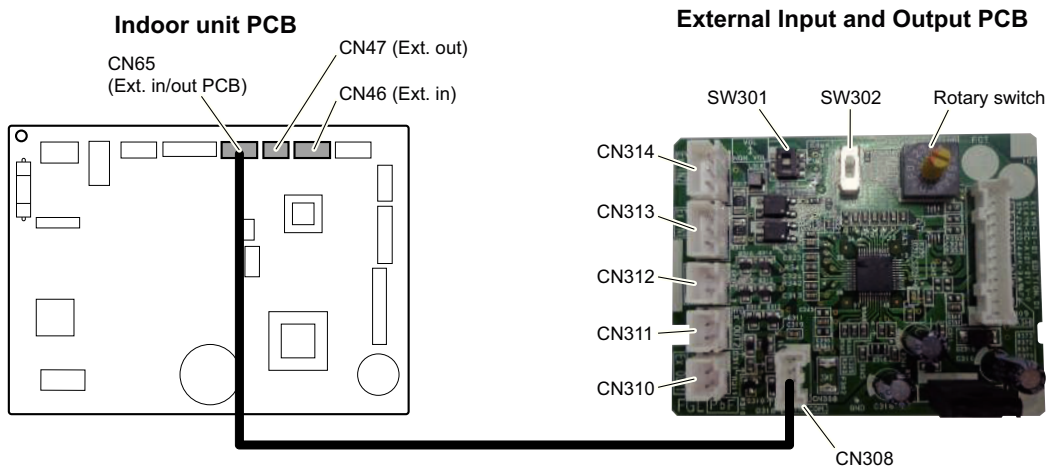

Connecting point		Input/Output	Function	Input select	Input signal
Indoor unit	CN46	Input	Operation/Stop	Dry contact	Edge
			Forced stop		
	CN47	Output	Operation/Stop	—	—
			Error status Indoor unit fan operation status		
External Input and Output PCB (UTY-XCSXZ2)	CN313 CN314	Input	Operation/Stop	Dry contact/Apply voltage	Edge/Pulse
			Forced stop		
	CN313		Forced thermostat off		Edge
	CN310 CN311 CN312	Output	Operation/Stop	—	—
Error status					
Indoor unit fan operation status					

NOTE: For details of the switching function, refer to "[Setting of external input and output](#)" on page 05-14.

FIELD WORKING

FIELD WORKING

2-1. External input

With using external input function, some functions on this product can be controlled from an external device.

- "Operation/Stop" mode or "Forced stop" mode can be selected with function setting of indoor unit.
- A twisted pair cable should be used. Maximum length of cable is 150 m.
- Use an external input and output cable with appropriate external dimension, depending on the number of cables to be installed.
- The wire connection should be separate from the power cable line.

■ Indoor unit

Indoor unit functions such as Operation/Stop can be done by using indoor unit connectors.

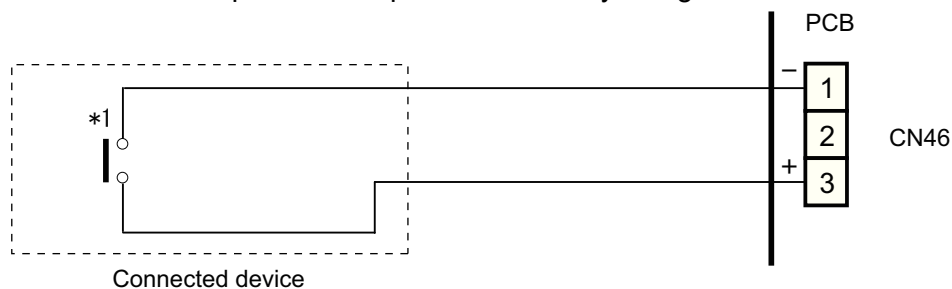

*1: The switch can be used on the following condition: DC 12 V to 24 V, 1 mA to 15 mA.

External Input and Output PCB

The indoor unit Operation/Stop can be set by using the input connector on the PCB.

• Input select

Use either one of these types of connectors according to the application. (Both types of connectors cannot be used simultaneously.)

– Dry contact

In case of internal power supply, set the slide switch of SW301 to "NON VOL" side.

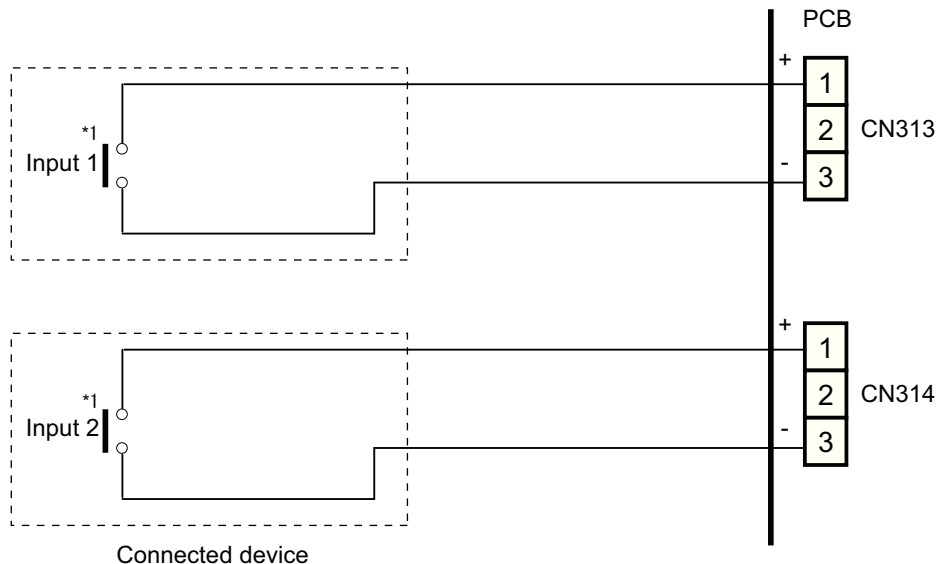

*1: The switches can be used on the following condition: DC 12 V to 24 V, 1 mA to 15 mA.

– Apply voltage

In case of external power supply, set the slide switch of SW301 to "VOL" side.

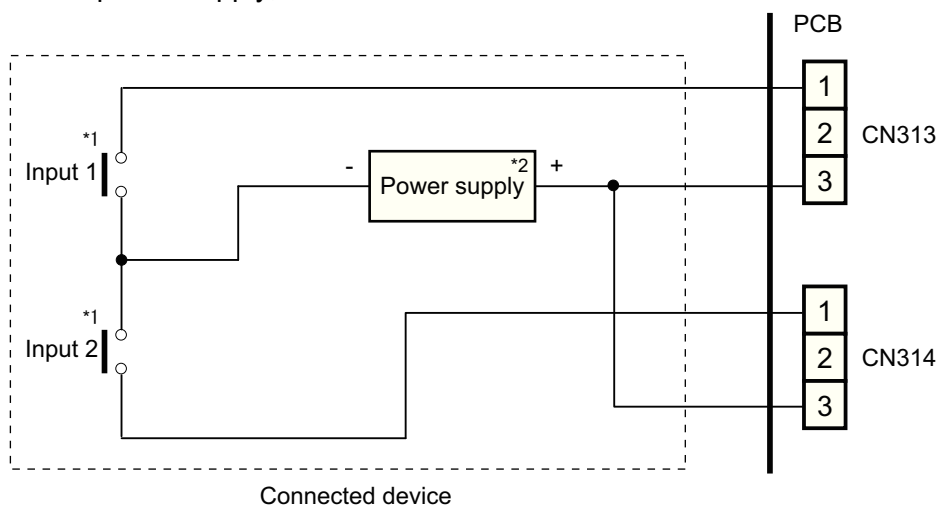

*1: The switches can be used on the following condition: DC 12 V to 24 V, 1 mA to 15 mA.

*2: Make the power supply DC 12 V to 24 V, 10 mA or more.

■ Input signal type

- **Indoor unit**

Input signal type is only "Edge".

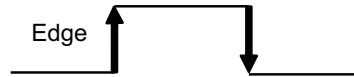

- **External Input and Output PCB**

The input signal type can be selected.

Signal type (edge or pulse) can be switched by the DIP switch 2 (SW302) on the External Input and Output PCB.

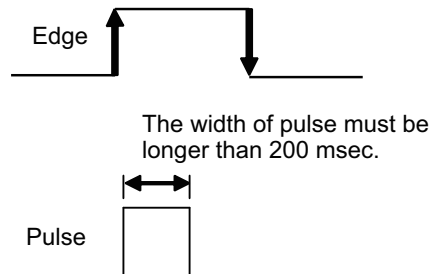

NOTE: The input signal supports the following switch type:

- Edge: Alternate type switch
- Pulse: Momentary type switch

2-2. External output

Use an external output cable with appropriate external dimension, depending on the number of cables to be installed.

Indoor unit

- A twisted pair cable should be used. Maximum length of cable is 25 m.
- Output voltage: High DC 12 V \pm 2 V, Low 0 V.
- Permissible current: 50 mA
- For details, refer to "[Setting of external input and output](#)" on page 05-14.
- **When indicator, etc. are connected directly**

Example: Function setting number 60 is set to "00"

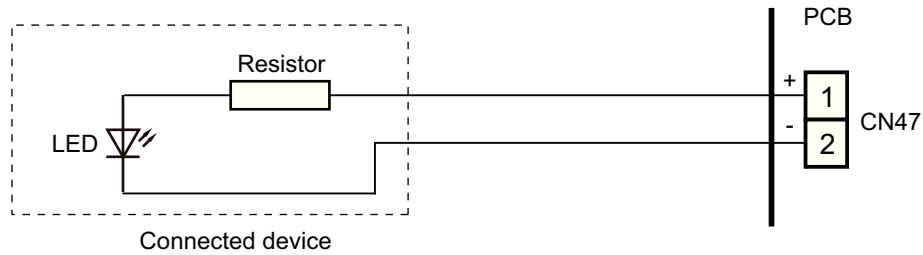

- **When connecting with a device equipped with a power supply**

Example: Function setting number 60 is set to "00"

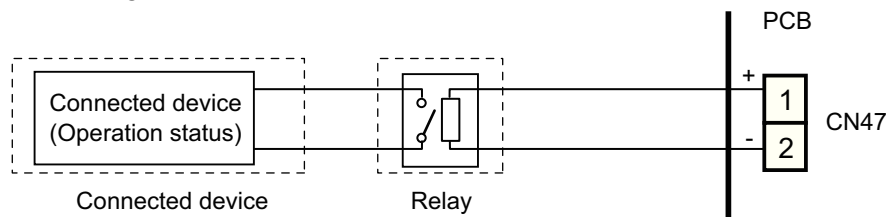

External Input and Output PCB

- A twisted pair cable should be used. Maximum length of cable is 25 m.
- Output voltage: High DC 12 V \pm 2 V, Low 0 V.
- Permissible current: 50 mA
- For details, refer to "[Setting of external input and output](#)" on page 05-14.
- **When indicator or other components are connected directly:**
Example: Rotary SW on External Input and Output PCB is set to "1".

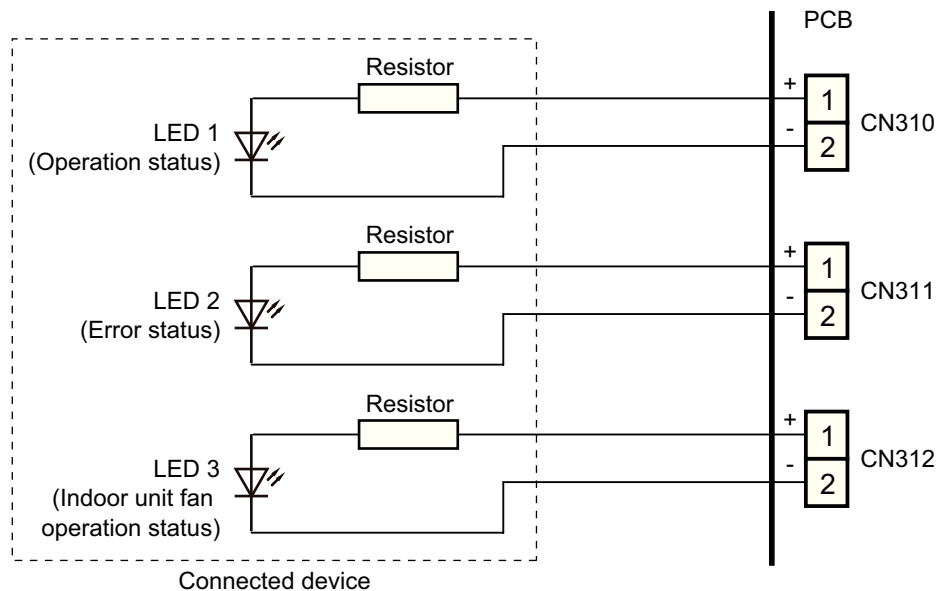

- **When connecting with a device equipped with a power supply:**
Example: Rotary SW on External Input and Output PCB is set to "1".

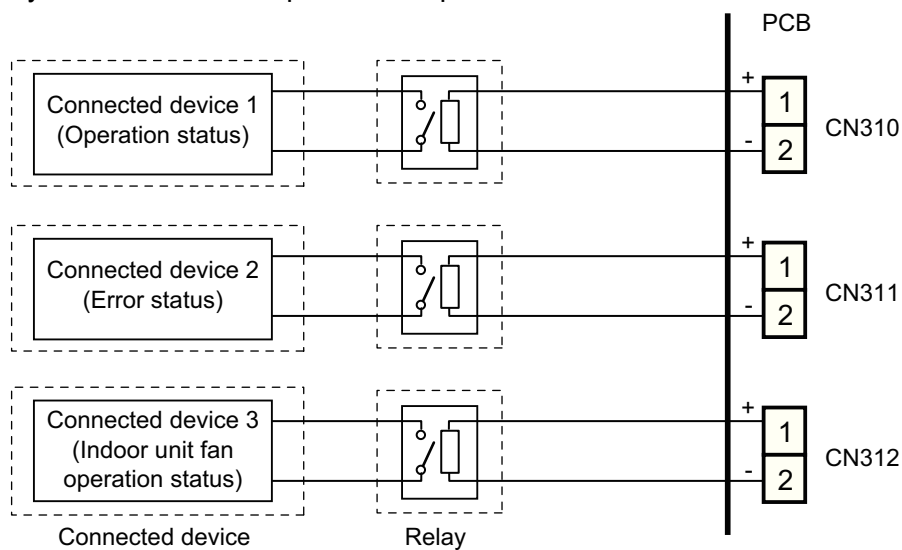

2-3. Setting of external input and output

- Indoor unit

Input		
Connection point	Function setting number 46	Function
CN46	00	Operation/Stop mode 1 (R.C. enabled)
	01	(Setting prohibited)
	02	Forced stop mode
	03	Operation/Stop mode 2 (R.C. disabled)

Output		
Connection point	Function setting number 60	Function
CN47	00	Operation/Stop
	01 to 08	(Setting prohibited)
	09	Error status
	10	Indoor unit fan operation status
	11	(Setting prohibited)

- External Input and Output PCB

Switch setting		Input		Output		
Rotary switch	SW302	CN313	CN314	CN310	CN311	CN312
1	Edge	Operation/Stop	Not available	Operation/Stop	Error status	Indoor unit fan operation status
	Pulse	Operation	Stop			
2	Edge*	Forced thermostat off	Not available	Error status	Indoor unit fan operation status	Not available
3 to 9, A		(Setting prohibited)				
B		Forced thermostat off	Not available	Operation/Stop	Indoor unit fan operation status	Not available
C		Forced thermostat off	Not available	Operation/Stop	Error status	Not available
D		Forced thermostat off	Not available	Operation/Stop	Indoor unit fan operation status	Error status

NOTES:

- When the rotary switch is selected to "1", the operation of the connector input of the indoor unit and the External Input and Output PCB input are the same. The operation content depends on the setting of function setting number 46.
- *: The external input other than "Operation/Stop" is available only when the SW302 is set to "Edge".

2-4. Details of control input function

■ Operation/Stop mode 1

- In the case of "Edge" input

Function setting	External Input and Output PCB		External input	Input signal	Command	
	Rotary switch	SW302				
46-00	—		Input of indoor unit	CN46	Off → On	Operation
	—		Input of indoor unit	CN46	On → Off	Stop
	1	Edge	External Input and Output PCB	CN313	Off → On	Operation
					On → Off	Stop

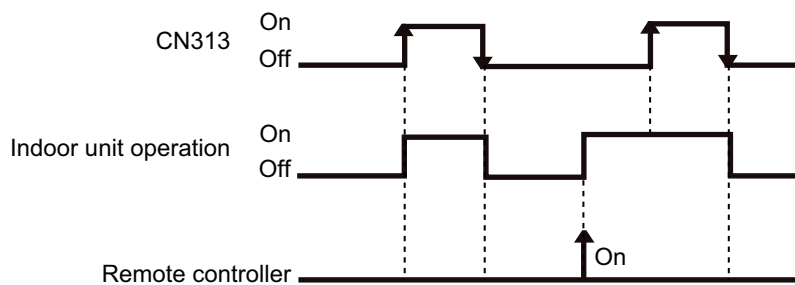

- In the case of "Pulse" input

Function setting	External Input and Output PCB		External input	Input signal	Command
	Rotary switch	SW302			
46-00	1	Pulse	External Input and Output PCB	CN313	Operation
			External Input and Output PCB	CN314	Stop

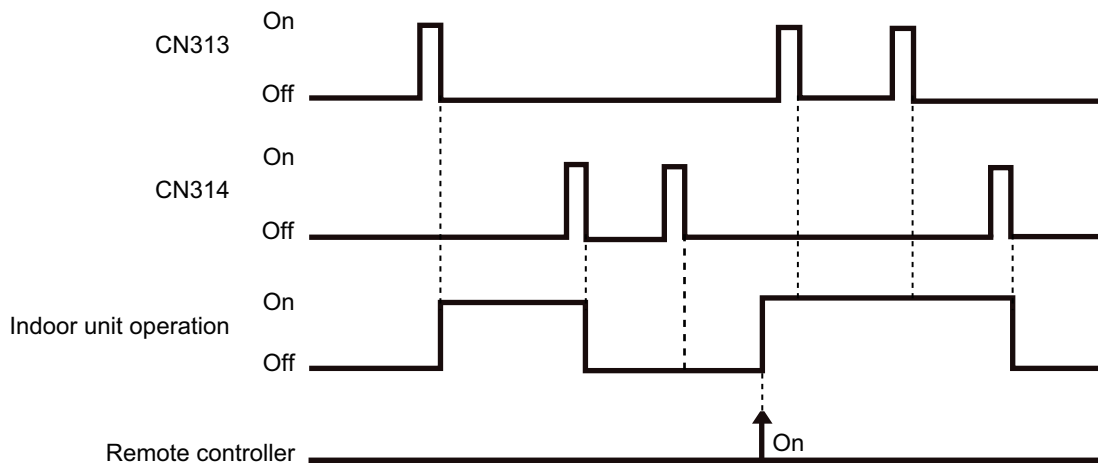

NOTES:

- The last command has priority.
- The indoor units within the same remote controller group operates in the same mode.

■ Forced stop

- In the case of "Edge" input

Function setting	External Input and Output PCB		External input		Input signal	Command
	Rotary switch	SW302				
46-02	—		Input of indoor unit	CN46	Off → On	Forced stop (R.C. disabled)
					On → Off	Normal (R.C. enabled)
	1	Edge	External Input and Output PCB	CN313	Off → On	Forced stop (R.C. disabled)
					On → Off	Normal (R.C. enabled)

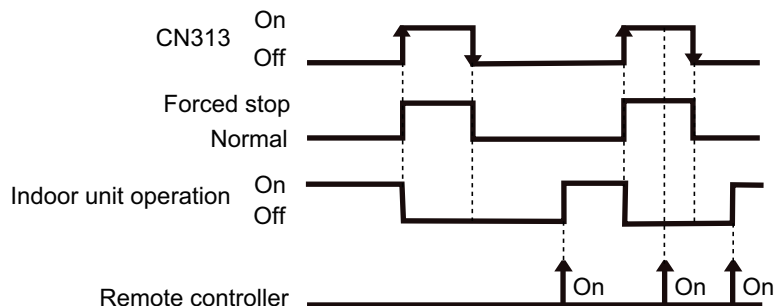

- In the case of "Pulse" input

Function setting	External Input and Output PCB		External input		Input signal	Command
	Rotary switch	SW302				
46-02	1	Pulse	External Input and Output PCB	CN313	Pulse	Forced stop (R.C. disabled)
				CN314		Normal (R.C. enabled)

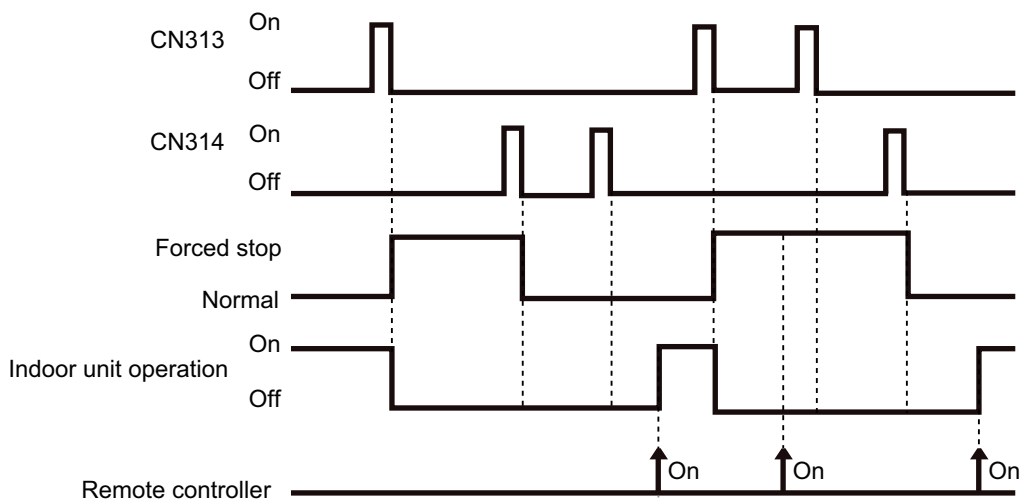

NOTES:

- When the forced stop is triggered, indoor unit stops and Operation/Stop operation by the remote controller is restricted.
- When forced stop function is used with forming a remote controller group, connect the same equipment to each indoor unit within the group.

■ Operation/Stop mode 2

- In the case of “Edge” input

Function setting	External Input and Output PCB		External input	Input signal	Command	
	Rotary switch	SW302				
46-03	—		Input of indoor unit	CN46	Off → On	Operation (R.C. enabled)
	—				On → Off	Stop (R.C. disabled)
	1	Edge	External Input and Output PCB	CN313	Off → On	Operation (R.C. enabled)
					On → Off	Stop (R.C. disabled)

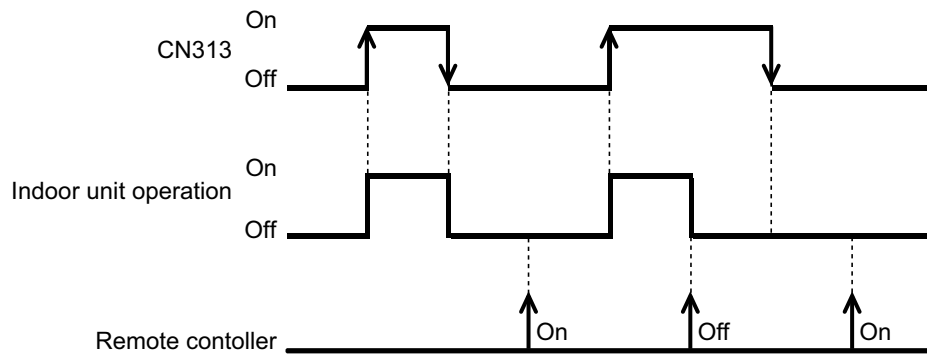

- In the case of “Pulse” input

Function setting	External Input and Output PCB		External input	Input signal	Command
	Rotary switch	SW302			
46-03	1	Pulse	External Input and Output PCB	CN313	Operation (R.C. enabled)
				CN314	Stop (R.C. disabled)

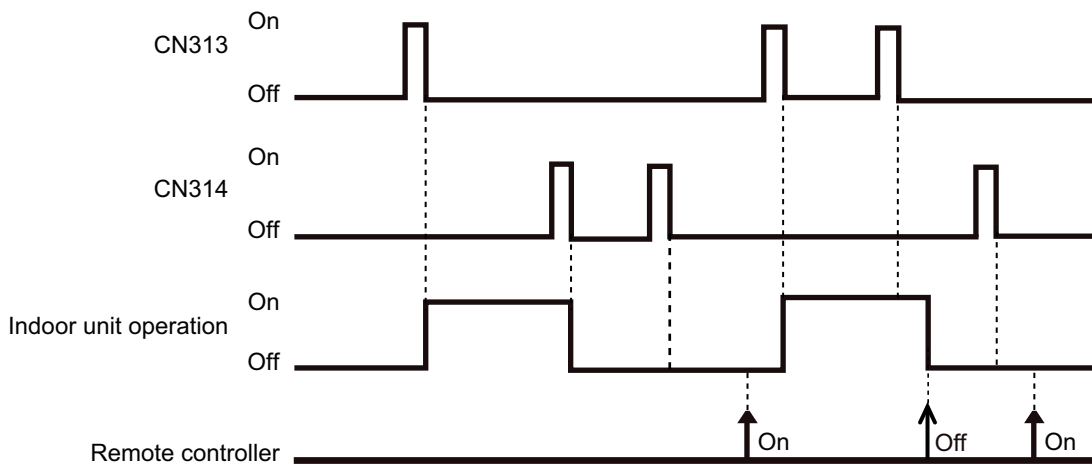

NOTE: When “Operation/Stop” mode 2 function is used with forming a remote controller group, connect the same equipment to each indoor unit within the group.

FIELD WORKING

FIELD WORKING

■ Forced thermostat off

External Input and Output PCB	External input		Input signal	Command
Rotary switch				
2, B, C, D	External Input and Output PCB	CN313	Off → On	Thermostat off
			On → Off	Normal operation

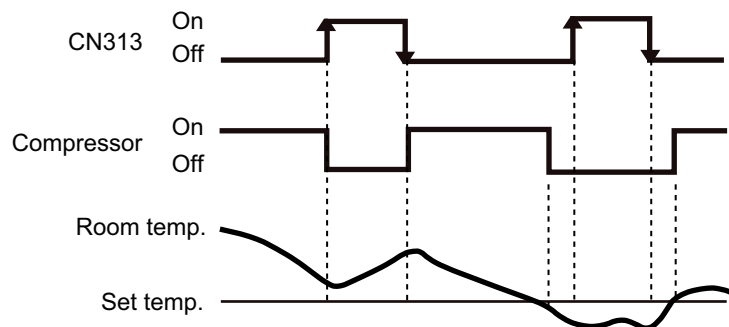

FIELD WORKING

FIELD WORKING

2-5. Details of control output function

■ Operation status

Function setting	External Input and Output PCB	External output		Output signal	Status
	Rotary switch				
60-00	1, 2	Output of indoor unit	CN47	Off → On	Operation
				On → Off	Stop
—	1, B, C, D	External Input and Output PCB	CN310	Off → On	Operation
				On → Off	Stop

The output is low when the unit is stopped.

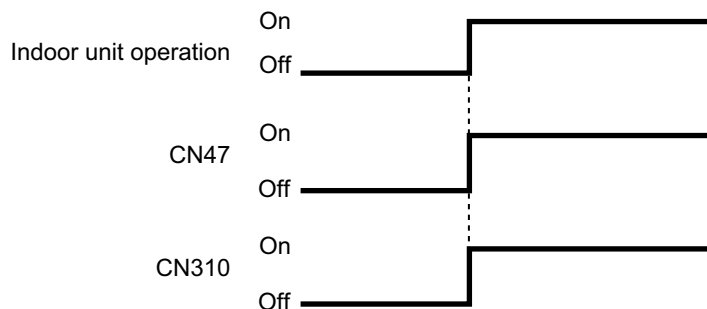

■ Error status

Function setting	External Input and Output PCB	External output		Output signal	Status
	Rotary switch				
60-09	—	Output of indoor unit	CN47	Off → On	Error
				On → Off	Normal
—	2	External Input and Output PCB	CN310	Off → On	Error
				On → Off	Normal
—	1, C	External Input and Output PCB	CN311	Off → On	Error
				On → Off	Normal
—	D	External Input and Output PCB	CN312	Off → On	Error
				On → Off	Normal

The output is on when an error is generated for the indoor unit.

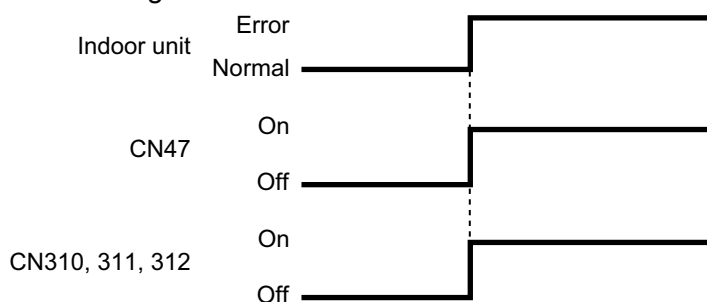

■ Indoor unit fan operation status

Function setting	External Input and Output PCB	External output		Output signal	Status
	Rotary switch				
60-10	C	Output of indoor unit	CN47	Off → On	Fan run
				On → Off	Fan stop
—	2, B, D	External Input and Output PCB	CN311	Off → On	Fan run
				On → Off	Fan stop
—	1	External Input and Output PCB	CN312	Off → On	Fan run
				On → Off	Fan stop

Output signal	Condition
On	The indoor unit fan is operating.
Off	The fan is stopped or during cold air prevention. During thermostat off when in dry mode operation.

