



## Light Commercial & Residential SPLIT

- S-004 Split Overview
- S-006 Indoor Units Lineup
- S-010 Features
- S-015 Features Explanation
- S-060 Wall-mounted Specifications
- S-063 ECO Series Lineup Specifications
- S-068 Feature Summary



### Refrigerant R32 models

**Wall-mounted type** - Built in W-LAN adapter model

- S-016 Designer Range
  - High Spec & Design
  - Cool Beauty Design
- S-020 Standard Range - High-Efficiency & Comfort
- S-022 ECO Range - Compact Size

### Wall-mounted type

- S-024 Standard Range
  - High-Efficiency & Large Rooms
- S-028 ECO Range
  - Compact Size
  - Comfort for Large Rooms
  - Cooling-enhanced type

### Cassette

- S-034 Compact 4-way Flow Range - Compact Size
- S-036 Circular Flow Range - Comfort for Large Rooms

### Duct

- S-038 Slim Duct - Slim Design
- S-040 Medium Static Pressure Duct
  - High-Efficiency & Comfort
  - Compact Size
  - Standard
- S-050 High Static Pressure Duct

### Floor, Ceiling

- S-056 Floor - Compact Size
- S-058 Ceiling



### Refrigerant R410A models

#### Duct

- S-052 High Static Pressure Duct
- S-054 Big Duct



# Split Overview

Fujitsu General provides its customers with 5 types and 149 models of air conditioning systems perfect for various customer applications and layouts. Added to this lineup recently are the environment-friendly R32 refrigerant models.



Wall-mounted type, Designer Series, Cool Beauty Design

## Existing pipes can be reused if they meet our guidelines

Please consult with our regional sales subsidiaries for details.

### Cautions when reusing the existing pipes

- The thickness of the pipes must be 0.8 mm or thicker in accordance with the pipe diameter.
- Use flares that have been reworked to be compatible with the new refrigerant, and are compliant with ISO 14903.
- Select suitable wiring in accordance with the installation manual of the new air conditioning unit.
- When pump-down is not possible or when the inner pipe walls are dirty, make sure to clean the pipes before connecting new ones.
- When using different diameters pipes from the standard sizes,
  - The performance may not reach the published specification value.
  - Dedicated flare nuts compliant with ISO 14903 should be procured locally.
  - Restrictions apply to pipe lengths, refrigerant volumes, and room sizes.



### Wall-mounted type

Simple and easy to install, all models, are expertly designed to control airflow and save energy. The design, with its flat and simple appeal, perfectly matches room interiors. Many of the models in the lineup adopt the new environmentally friendly R32 refrigerant.



### Duct

The main unit is hidden in the wall, making the room look neat and tidy. Mini Duct and Slim Duct models are also available for installation in narrow spaces between beams or above the ceiling. Large models, suitable for air conditioning vast spaces, allow multiple outlets to be installed in just one unit, and are perfect for atypical room layouts.



### Cassette

The Cassette type, which blends in perfectly with the interior design, blows air in all four directions to create an even air-conditioning for the entire space. We have a variety of series including Compact models with a uniquely designed panel to match grid ceilings, and Circular Flow models that send airflow in a 360° direction.



### Floor

The compact and slim design makes this model suitable for installation in commercial as well as residential buildings. This model is also recommended as a heating device because it delivers a warm airflow from both the top and bottom outlets.



### Ceiling

As with the wall-mounted unit, ceiling installation is very easy, and the unit's thin structure with a height of just 240 mm allows neat installation. The powerful airflow that can reach far away from the wide outlet is perfect for large meeting rooms, audiovisual rooms, and other rectangular spaces with a lot of depth.



# Indoor Units Lineup



FUJITSU GENERAL (Euro) GmbH participates in the ECP program for AC. Check ongoing validity of certificate: [www.eurovent-certification.com](http://www.eurovent-certification.com)

Type	Range	Refrigerant	Model	Class													
				7	9	12	14	18	22	24	30	36	45	54	60	72	90
Wall-mounted type Built in WLAN adapter model	Designer Range High Spec & Design	Cooling & Heating	<b>NEW</b>	ASEH07KGTG	ASEH09KGTG	ASEH12KGTG	ASEH14KGTG										
	Designer Range Cool Beauty Design	Cooling & Heating		ASEG07KETF ASEG07KETF-B	ASEG09KETF ASEG09KETF-B	ASEG12KETF ASEG12KETF-B	ASEG14KETF ASEG14KETF-B										
	Standard Range High-Efficiency & Comfort	Cooling & Heating	<b>NEW</b>	ASEH07KMCG	ASEH09KMCG	ASEH12KMCG	ASEH14KMCG										
	ECO Range Compact Size	Cooling & Heating	<b>NEW</b>	ASEH07KNCA	ASEH09KNCA	ASEH12KNCA											
Wall-mounted type	Standard Range High-Efficiency & Large Rooms	Cooling & Heating						ASEG18KMTE		ASEG24KMTE							
	Standard Range High-Efficiency & Large Rooms	Cooling & Heating									ASEH30KMTB	ASEH36KMTB					
	ECO Range Compact Size	Cooling & Heating		ASEG07KPCE	ASEG09KPCE	ASEG12KPCE											
	ECO Range Comfort for Large Rooms	Cooling & Heating						ASEG18KLCA		ASEG24KLCA							
	ECO Range Cooling-enhanced	Cooling & Heating	<b>NEW</b>	ASEH07KLTA	ASEH09KLTA	ASEH12KLTA											

# Indoor Units Lineup



FUJITSU GENERAL (Euro) GmbH participates in the ECP program for AC. Check ongoing validity of certificate: [www.eurovent-certification.com](http://www.eurovent-certification.com)

Type	Range	Refrigerant	Model	Class													
				7	9	12	14	18	22	24	30	36	45	54	60	72	90
Cassette	Compact 4-way Flow Range Compact Size	Cooling & Heating			AUXG09KVLA	AUXG12KVLA	AUXG14KVLA	AUXG18KVLA	AUXG22KVLA	AUXG24KVLA							
	Circular Flow Range Comfort for Large Rooms	Cooling & Heating	 18/22/24 30/36/45/54					AUXG18KRLB	AUXG22KRLB	AUXG24KRLB	AUXG30KRLB	AUXG36KRLB	AUXG45KRLB	AUXG54KRLB			
Duct	Slim Duct	Cooling & Heating	 09/12/14 18		ARXG09KLLAP	ARXG12KLLAP	ARXG14KLLAP	ARXG18KLLAP									
	Medium Static Pressure Duct High-Efficiency & Comfort	Cooling & Heating	 12/14/18 22/24 30/36/45/54			ARXH12KMTAP	ARXH14KMTAP	ARXH18KMTAP	ARXH22KMTAP	ARXH24KMTAP	ARXH30KMTAP	ARXH36KMTAP	ARXH45KMTAP	ARXH54KMTAP			
	Medium Static Pressure Duct Compact Size	Cooling & Heating	 12/14 18/22/24/30 36/45/54			ARXG12KHTAP	ARXG14KHTAP	ARXG18KHTAP	ARXG22KHTAP	ARXG24KHTAP	ARXG30KHTAP	ARXG36KHTAP	ARXG45KHTAP	ARXG54KHTAP			
	Medium Static Pressure Duct Standard	Cooling & Heating							ARXG22KMLB	ARXG24KMLA	ARXG30KMLA	ARXG36KMLA	ARXG45KMLA				
	High Static Pressure Duct	Cooling & Heating											ARXG45KHTB	ARXG54KHTB			
		Cooling & Heating													ARYG60LHTA		
	Big Duct	Cooling & Heating														ARYG72LHTA	ARYG90LHTA
Floor Compact & Comfort	Cooling & Heating				AGEG09KVCA	AGEG12KVCA	AGEG14KVCA										
Ceiling	Cooling & Heating	 18/22 24/30 36/45/54						ABEG18KRTA	ABEG22KRTA	ABEG24KRTA	ABEG30KRTA	ABEG36KRTA	ABEG45KRTA	ABEG54KRTA			



# Features

## High-Efficiency

### ALL DC All DC Inverter Technology



#### DC twin-rotary compressor

A high-efficiency 2-cylinder rotary compressor with a DC inverter optimizes the internal structure of the compressor to achieve higher energy efficiency compared to similar compressors.

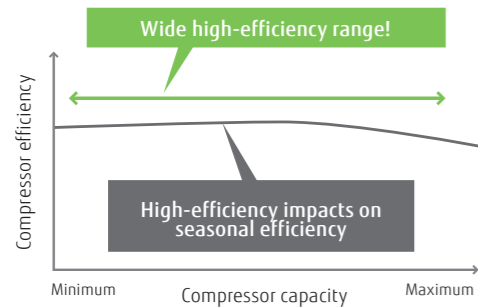

#### DC fan motor

The DC fan motor produces high power, a wide operating range, and high-efficiency.

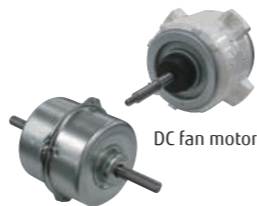

#### Sine-wave DC inverter control

High-efficiency operation is realized by using sine-wave DC inverter control.

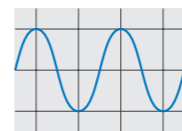

### Heat Exchanger for Wall-mounted type

#### High-density multipath heat exchanger

Thinner and denser heat exchangers and multipath efficiency technology have substantially improved heat exchange performance.

#### High-performance sub-cool heat exchanger

A counter-type bypass circuit has been incorporated to achieve a higher performance. (Large multi-split type, VRF)

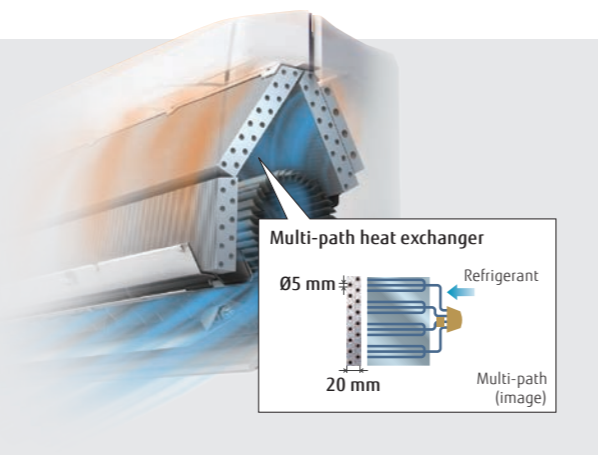

## High Energy Saving

### Human sensor control

The Human sensor monitors the movements of people in a room and operates the air conditioner at a lower capacity when people leave the room. When people come back to the room, it automatically returns to the previous operating mode.

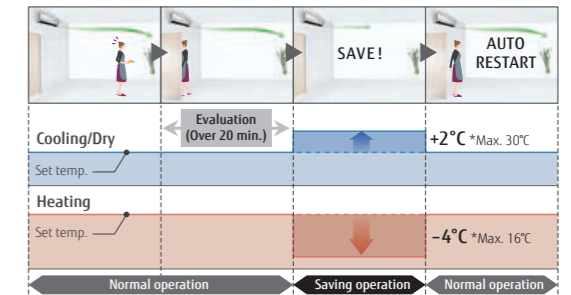

### Economy operation

Limits maximum operation, reducing the power consumption, and thereby suppressing the maximum load.

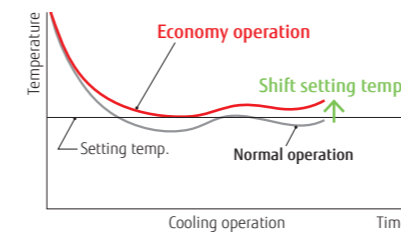

### Setting temperature range limitation

The minimum and maximum temperature range can be set giving further energy savings while considering the comfort of the occupants.

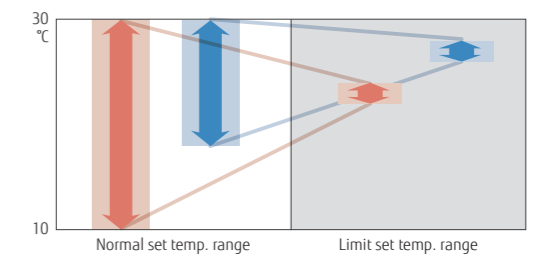

### Set temperature auto return

- The set temperature automatically returns to the previously set temperature.
- The time range in which the set temperature can be changed is from 10 to 120 minutes.

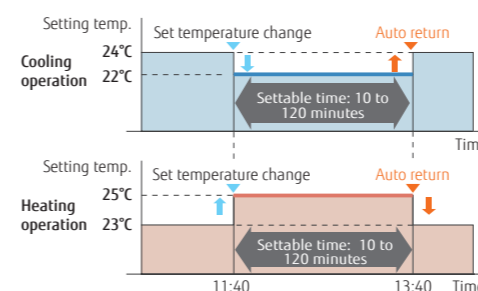

### Auto-off timer

- The indoor unit is automatically turned off when it reaches a preset operating time frame.
- The time frame of the Auto-off timer can be flexibly scheduled.
- Auto-off times can be set from 30 to 240 minutes.

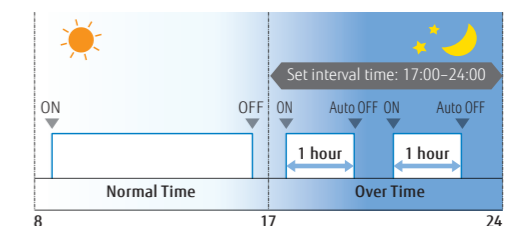

# More Comfort



**Power diffuser**  
 These three technologies enable precise wind direction control and improve ventilation efficiency; our airflow control offers a more comfortable environment.

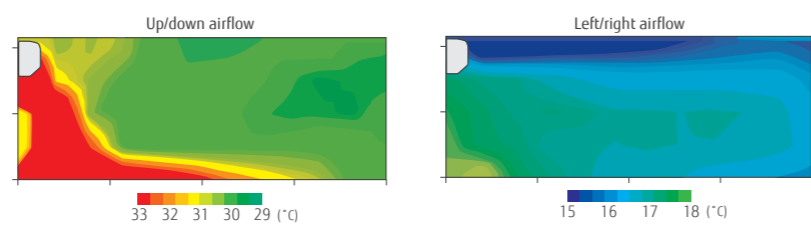

**Wireless LAN control**  
 Users can control their air conditioners from anywhere with their mobile devices while out or on the move.

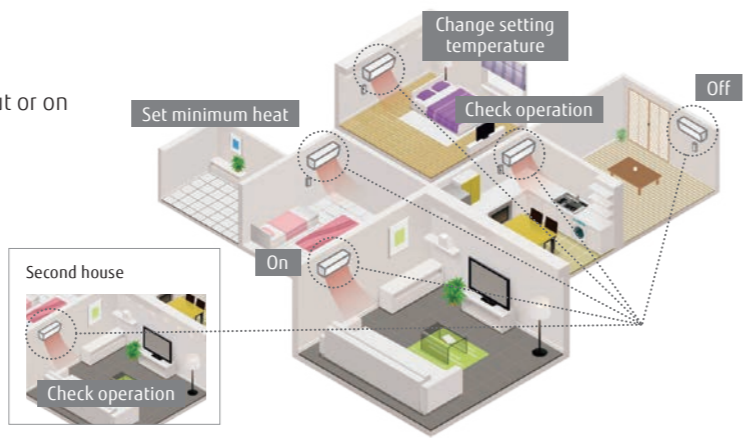

**Powerful operation**  
 Maximum airflow and maximum compressor speed are maintained for the period necessary to reach the set temperature quickly.

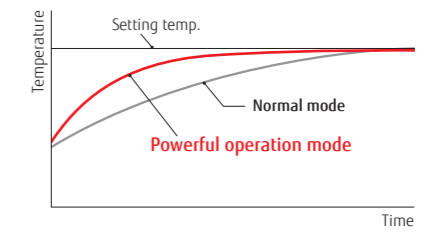

**10°C heat**  
 After a person has left the room, the system switches to minimum heating operation to maintain the room temperature. (Maintained at 10°C)

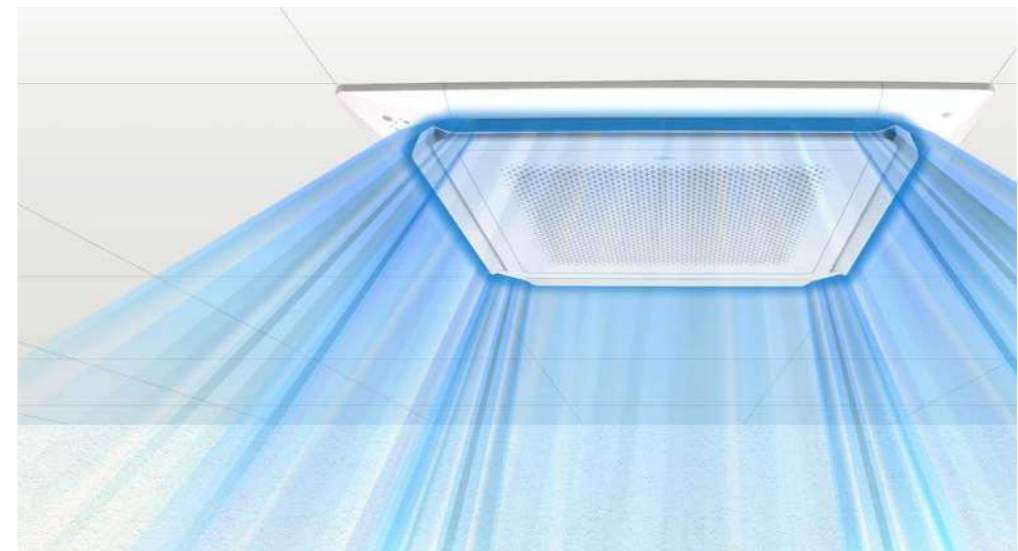
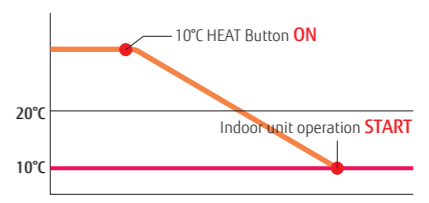

**Uniform air conditioning**  
 Circular airflow to achieve uniform air conditioning without temperature unevenness in workspaces





# Quiet and Comfort Control



## Low Noise Technology

### Outdoor unit fan

Outdoor unit fan design with a small separation vortex, minimized air volume by fan control, and top-class low noise

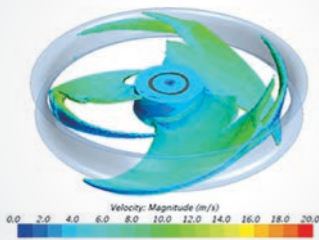

### Air stabilizer in Duct

Low-noise duct structure with a built-in air stabilizer

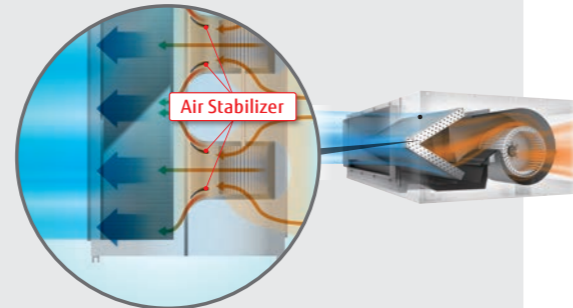

### Outdoor unit low noise operation

Users can choose low noise levels, depending on the installation environment. Operation time can be set by timer.

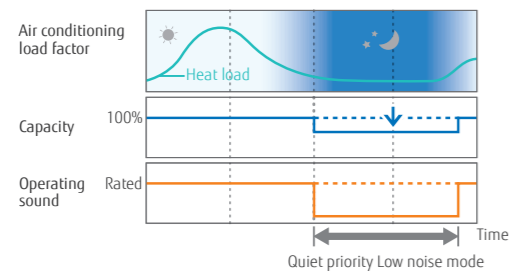

### Auto changeover

In an auto setting, the system automatically switches between cooling and heating modes according to the set temperature and room temperature.

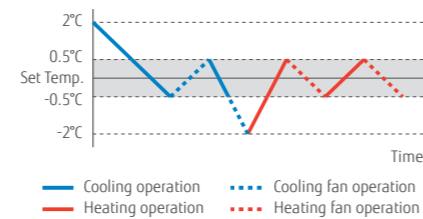

### Fresh air intake for Cassette, Duct, Ceiling

Fresh air is taken in by a fan connected to an external control unit.



# Feature Explanation

## Energy-Saving Features

- Save Human sensor**  
The Human sensor detects the movement of people in the room and determines whether to switch to energy saving operation.
- Human sensor control**  
The Human sensor (option) detects movement of people in the room and decides whether to save energy or stop the unit.
- Economy operation**  
The thermostat setting is adjusted automatically according to the room temperature to avoid unnecessary cooling or heating.
- Setting temperature range limitation**  
Sets the minimum and maximum limits on room temperature to establish the right balance between energy saving and a comfortable environment.
- Set temperature auto return**  
The setting temperature automatically returns to the previously set temperature.

## Features for Comfort

- Power diffuser**  
An additional louver that opens based on input from monitoring sensors to quickly enhance immediate comfort needs.
- Powerful operation**  
Operation at maximum air flow and compressor speed, that quickly makes the room comfortable.
- 10°C Heat**  
The room temperature can be set to go no lower than 10°C, thus ensuring that the room does not get too cold when not occupied.
- Outdoor unit low noise operation**  
The noise level of the outdoor unit can be selected.
- Auto changeover**  
The unit automatically switches between heating and cooling modes based on the temperature setting and the room temperature.
- UP/DOWN swing louver**  
The vertical louver automatically swings up and down.
- Double swing automatic**  
Complex swing action of the louver enables automatic swing in both the left/right and up/down directions.
- Automatic fan speed**  
A micro-computer automatically adjusts the airflow to follow the changes in room temperature.
- Auto restart**  
In the event of a temporary power failure, the air conditioner will automatically restart in the same operating mode as before, once the power supply is restored.
- Connectable fresh air duct**  
Outside air can be introduced by attaching a locally purchased duct to the fresh air knockout and an optional part.
- Fresh air intake**  
Fresh air can be taken in by a fan connected to an external control unit.
- Connectable distributing duct**  
Locally purchased branch ducts can be attached to the systems to distribute the airflow.
- Individual airflow direction control**  
Each louver of a 4-way Cassette type can be controlled individually to provide comfortable airflow.

## Convenience Features

- Auto-off timer**  
Automatically stops operation when a fixed time has elapsed from the start of operation.
- Sleep timer**  
A micro-computer gradually changes the room temperature automatically to promote a comfortable night's sleep.
- Program timer**  
This digital timer allows selection of one of four options: ON, OFF, ON + OFF, or OFF + ON.
- Weekly timer**  
Different ON-OFF times can be set for each day.
- Weekly & Temperature setback timer**  
Weekly & Temperature setback timer can set the temperature for 2-time spans and for each day of the week.
- Filter sign**  
Indicates the filter cleaning period by blinking.
- External error output**
- External ON/OFF input**
- Wireless LAN control**  
The optional WLAN adapter enables the air conditioner to be operated by smartphone or tablet PC from outside the home.
- Multi System Control**  
Operation using "Lead Lag Operation", "Back up operation", "Lag Operation" is possible. (Page C-011)
- Special Cooling**  
Special Cooling" is a function that supports the operation of "Multi System Control".

## Clean Features

- Ion deodorization filter**  
The filter deodorizes by powerfully decomposing absorbed odors using the oxidizing and reducing effects of ions generated by an ultra-fine-particle ceramic.
- Apple-catechin filter**  
The Apple-catechin filter uses static electricity to clean fine particles and dust from the air.
- Long-life filter**
- Washable panel**  
Since the front panel is easy to remove, maintenance is also easy.
- Silver Ion Filter**  
The Silver ion filter helps to keep indoor air free from viruses, bacteria and molds.

## Installation / Support

- Automatic airflow adjustment**  
Automatically detects required airflow in each application case and adjusts the volume.
- Drain pump as standard**
- Blue fin**
- Refrigerant cycle monitor**  
The values of each sensor and actuator can be displayed, and the status of the refrigeration cycle can be checked.





# Wall-mounted type

Built-in WLAN adapter model  
Designer Range  
High Spec & Design

KG Series



## High energy saving

Top class high efficiency is achieved by high efficient lambda-shaped heat exchanger, large cross flow fan and new refrigerant.

Rank **A+++\*** SEER **9.80\*** SCOP **5.20\***

\*07/09/12 models      \*07 model      \*07/09/12 models

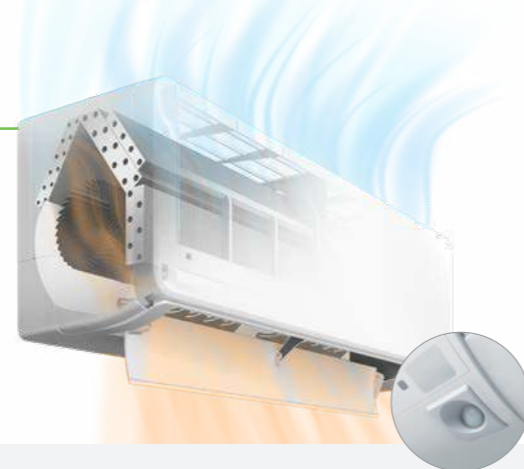

### Hybrid-heat exchanger

The large hybrid heat exchanger has greatly improved the heat exchange efficiency to achieve top-level SEER and SCOP.

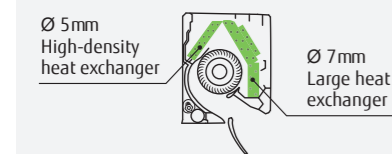

### Ø107 Large cross-flow fan

The large-diameter fan generates air volume efficiently even at reduced power.

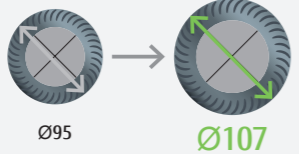

### Human sensor

The Human sensor monitors the movements of people in a room and operates the air conditioner at a lower capacity when people leave the room. When people come back to the room, it automatically returns to the previous operating mode.

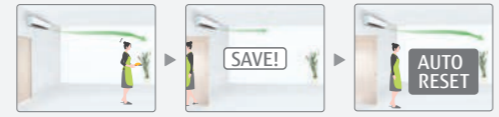

## Comfortable airflow & Quiet operation

The large louver and the new air-blowing structure create a comfortable air flow that spreads all the way down to the user's feet with quiet operation.



## Smart device control

A WLAN adapter is included as standard equipment. By installing the AIRSTAGE mobile app on your smart device, you can check and control the operating status of the air conditioner from anywhere indoors or outdoors.

\* See page C-020 for details on smart device control.



## Refrigerant cycle monitor (Option)

Wired Remote Controller (Touch Panel) will support to display some sensor values for maintenance and service support.

\*Wired remote controller (UTY-RNRY25 or UTY-RVRY) is required.

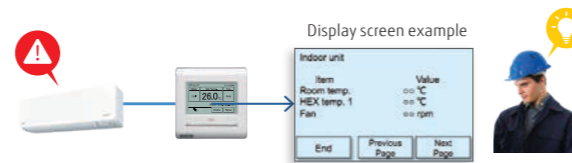

Model: ASEH07KGTG / ASEH09KGTG / ASEH12KGTG / ASEH14KGTG



## Specifications

Model name	Indoor unit		Outdoor unit		ASEH07KGTG	ASEH09KGTG	ASEH12KGTG	ASEH14KGTG
	AOEH07KGGC		AOEH09KGGC		AOEH12KGGC	AOEH14KGGC	AOEH14KGGC	AOEH14KGGC
Power Source	Single phase, ~230 V, 50 Hz							
Capacity	Cooling	Rated	kW	2.0	2.5	3.4	4.2	
		Min.-Max.		0.9-3.3	0.9-3.6	0.9-4.1	0.9-4.5	
	Heating	Rated	2.5	2.8	4.0	5.4		
Input Power	Cooling/Heating	Min.-Max.	kW	0.9-5.2	0.9-5.4	0.9-6.1	0.9-6.4	
		EER	W/W	5.00	4.55	3.91	3.44	
COP	Cooling/Heating	Rated	W/W	5.00	4.67	4.40	3.72	
		Pdesign	kW	2.0 / 2.3	2.5 / 2.4	3.4 / 2.5	4.2 / 4.0	
SEER	Cooling	Rated	W/W	9.80	9.40	8.80	8.00	
		SCOP	Heating (Average)	W/W	5.20	5.20	5.20	4.60
Energy Efficiency Class	Cooling/Heating	Cooling	A+++	A+++	A+++	A++		
		Heating (Average)	A+++	A+++	A+++	A++		
Max. Operating Current	Cooling/Heating	A	6.5 / 9.0	6.5 / 9.0	6.5 / 9.0	9.0 / 10.5		
Annual Energy Consumption	Cooling/Heating	kWh/a	71	93	135	184		
		Moisture Removal	l/h	618	646	673	1,217	
Sound Pressure Level	Indoor (Cooling/Heating)	H/M/L/Q	dB(A)	36 / 32 / 29 / 19	38 / 34 / 29 / 19	40 / 35 / 30 / 19	43 / 36 / 30 / 20	
		High	38 / 34 / 31 / 20	39 / 34 / 31 / 20	42 / 38 / 33 / 21	44 / 39 / 33 / 24		
Sound Power Level	Indoor (Cooling/Heating)	High	dB(A)	42 / 43	44 / 45	50 / 50	50 / 50	
		High	49 / 51	52 / 52	56 / 58	57 / 59		
Airflow Rate	Indoor/Outdoor (Cooling/Heating)	High	m <sup>3</sup> /h	56 / 56	58 / 58	65 / 66	65 / 66	
		High	570 / 1,390	640 / 1,480	680 / 1,800	750 / 1,800		
Net Dimensions	Indoor	mm	270 × 834 × 215	270 × 834 × 215	270 × 834 × 215	270 × 834 × 215		
		Outdoor	mm	542 × 799 × 290	542 × 799 × 290	542 × 799 × 290	542 × 799 × 290	
Weight	Indoor	kg	10	10	10	10		
		Outdoor	kg	30	30	31	32	
Connection Pipe Diameter (Liquid/Gas)	mm	6.35 / 9.52	6.35 / 9.52	6.35 / 9.52	6.35 / 9.52			
Drain Hose Diameter (I.D./O.D.)	mm	13.8 / 15 to 16.8	13.8 / 15 to 16.8	13.8 / 15 to 16.8	13.8 / 15 to 16.8			
Max. Pipe Length (Pre-Charge)	m	20 (15)	20 (15)	20 (15)	20 (15)			
Max. Height Difference	m	15	15	15	15			
Operating Range	Cooling/Heating	°CDB	-10 to 50	-10 to 50	-10 to 50	-10 to 50		
		°CDB	-15 to 24	-15 to 24	-15 to 24	-15 to 24		
Refrigerant	Type (Global Warming Potential)	Charge	kg (CO <sub>2</sub> eq-T)	R32 (675)	R32 (675)	R32 (675)	R32 (675)	
		Charge	kg (CO <sub>2</sub> eq-T)	0.75 (0.506)	0.75 (0.506)	0.85 (0.574)	0.85 (0.574)	

## Optional parts

\* For optional parts compatibility of Intesis devices, please refer to the optional parts compatibility list page C-050 to C-053 and C-066.

- Wired Remote Controller (Design type): UTY-RVRY
- Compact wired remote controller: UTY-RCRYZ1
- Wired remote controller (touch panel): UTY-RNRY25
- Wired remote controller: UTY-RLRY
- Simple remote controller (without operation mode): UTY-RHRY
- Simple remote controller: UTY-RSRY
- External switch controller: UTY-TERX
- Communication kit: UTY-TWRXZ2
- External connect kit: UTY-XWZX
- Simple remote controller: UTY-RSRY
- External switch controller: UTY-TERX
- Communication kit: UTY-TWRXZ2
- External connect kit: UTY-XWZX
- External connect kit: UTY-XWZX
- Network Converter for single split (DC power supply type): UTY-VTGX
- Network Converter for single split (AC power supply type): UTY-VTGXV
- Silver Ion filter: UTR-FA16-5
- External input and output PCB\*: UTY-XCSXZ2

\*1 It is required when 2 or more external input and output ports are used.

## Dimensions

(Unit: mm)

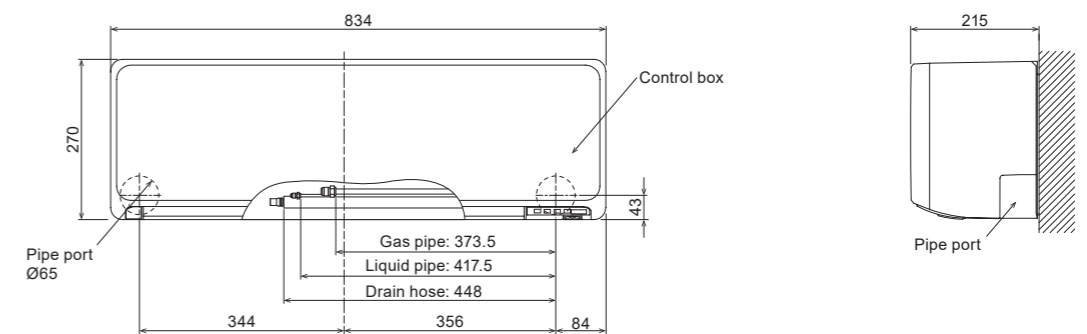

# Wall-mounted type

Built-in WLAN adapter model  
Designer Range  
Cool Beauty Design



KE Series



## Cool beauty design

We have designed this series exclusively for the European market. The exterior design harmonizes beautifully with any decor and adds comfortable elegance to the room. The light, elegant and three-dimensional expression achieved by the curved surface is beautiful from any angle.



### CMF: COLOR MATERIAL FINISH

The texture of the front panel expresses the craftsmanship of Europe, and changes its expression with the changing light of the day.

## High energy saving

Top class high efficiency is achieved by high efficient lambda-shaped heat exchanger, large cross flow fan and new refrigerant.

Rank Cooling\*1: **A++**  
Rank Heating\*2: **A+**

SEER **7.4** \*1  
SCOP **4.4** \*2

\*1: 07/09 models    \*2: 12 model

### Hybrid-heat exchanger

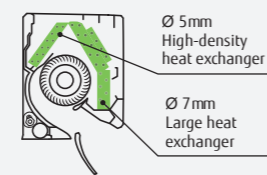

### Ø107 Large cross-flow fan



## Smart device control

A WLAN adapter is included as standard equipment. By installing the AIRSTAGE mobile app on your smart device, you can check and control the operating status of the air conditioner from anywhere indoors or outdoors.

\* See page C-020 for details on smart device control.



## Comfortable airflow & Quiet operation

The large louver and the new air-blowing structure create a comfortable air flow that spreads all the way down to the user's feet with quiet operation.



Model: ASEG07KETF / ASEG09KETF / ASEG12KETF / ASEG14KETF (Peal white X White)  
ASEG07KETF-B / ASEG09KETF-B / ASEG12KETF-B / ASEG14KETF-B (Silver X Dark gray)



Peal white X White



Silver X Dark gray



## Specifications

Model name	Indoor unit		Outdoor unit		ASEG07KETF ASEG07KETF-B	ASEG09KETF ASEG09KETF-B	ASEG12KETF ASEG12KETF-B	ASEG14KETF ASEG14KETF-B	
					AOEG07KETA	AOEG09KETA	AOEG12KETA	AOEG14KETA	
Power Source					Single phase, ~230 V, 50 Hz				
Capacity	Cooling	Rated	kW			2.0	2.5	3.4	4.2
		Min.-Max.				0.9 - 3.0	0.9 - 3.2	0.9 - 3.9	0.9 - 4.4
	Heating	Rated	kW			2.5	2.8	4.0	5.4
		Min.-Max.				0.9 - 3.4	0.9 - 4.0	0.9 - 5.3	0.9 - 6.0
Input Power	Cooling/Heating		kW			0.450/0.555	0.630/0.620	0.935/0.960	1.220/1.410
EER	Cooling		W/W			4.43	3.97	3.65	3.44
COP	Heating		W/W			4.52	4.52	4.17	3.83
Pdesign	Cooling/Heating (-10°C)		kW			2.0/2.3	2.5/2.4	3.4/2.5	4.2/4.0
SEER	Cooling		W/W			7.40	7.30	7.30	6.90
SCOP	Heating (Average)		W/W			4.10	4.10	4.40	4.10
Energy Efficiency Class	Cooling					A++	A++	A++	A++
	Heating (Average)					A+	A+	A+	A+
Max. Operating Current	Cooling/Heating		A			6.5/9.0	6.5/9.0	6.5/9.0	6.5/9.0
Annual Energy Consumption	Cooling		kWh/a			95	118	163	213
	Heating		kWh/a			785	819	795	1,367
Moisture Removal			l/h			1.0	1.3	1.8	2.1
Sound Pressure Level	Indoor (Cooling)	H/M/L/Q	dB(A)			38/33/29/20	40/34/29/20	40/35/30/20	43/36/30/20
	Indoor (Heating)	H/M/L/Q				41/35/31/22	42/36/31/22	42/38/33/22	44/39/33/24
Sound Power Level	Outdoor (Cooling/Heating)	High	dB(A)			46/46	46/46	50/50	50/50
	Indoor (Cooling/Heating)	High				54/56	55/57	55/58	57/59
	Outdoor (Cooling/Heating)	High				61/61	61/62	65/65	65/66
	Indoor/Outdoor (Cooling)	High				650/1,650	700/1,650	700/1,700	770/1,680
Airflow Rate	Indoor/Outdoor (Heating)	High	m³/h			720/1,450	750/1,450	770/1,470	800/1,580
						295 × 950 (wall side: 840) × 230			
Net Dimensions H x W x D	Indoor		mm			295 × 950 (wall side: 840) × 230			
	Outdoor		mm			541 × 663 × 290	541 × 663 × 290	541 × 663 × 290	542 × 799 × 290
Weight	Indoor		kg			11	11	11	11.5
	Outdoor		kg			23	23	25	31
Connection Pipe Diameter (Liquid/Gas)			mm			6.35/9.52	6.35/9.52	6.35/9.52	6.35/9.52
Drain Hose Diameter (I.D./O.D.)			mm			13.8/15.0 to 16.8	13.8/15.0 to 16.8	13.8/15.0 to 16.8	13.8/15.0 to 16.8
Max. Pipe Length (Pre-Charge)			m			20 (15)	20 (15)	20 (15)	20 (15)
Max. Height Difference						15	15	15	15
Operating Range	Cooling		°CDB			-10 to 46	-10 to 46	-10 to 46	-10 to 46
	Heating					-15 to 24	-15 to 24	-15 to 24	-15 to 24
Refrigerant	Type (Global Warming Potential)					R32 (675)	R32 (675)	R32 (675)	R32 (675)
	Charge		kg (CO2eq-T)			0.6 (0.405)	0.6 (0.405)	0.7 (0.473)	0.85 (0.574)

## Optional parts

\* For optional parts compatibility of Intesis devices, please refer to the optional parts compatibility list page C-050 to C-053 and C-066.

Wired Remote Controller (Design type):	UTY-RVRY	Simple remote controller:	UTY-RSRY	Network Converter for single split (DC power supply type):	UTY-VTGX
Compact wired remote controller:	UTY-RCRYZ1	Communication kit:	UTY-TWRXZ2	Network Converter for single split (AC power supply type):	UTY-VTGXV
Wired remote controller (touch panel):	UTY-RNRYZ5	External connect kit:	UTY-XWZX	Silver Ion filter:	UTR-FAT6-5
Wired remote controller:	UTY-RLRY		UTY-XWZXZ5	External input and output PCB*1:	UTY-XCSXZ2
Simple remote controller (without operation mode):	UTY-RHRY	External switch controller:	UTY-TERX		

\*1 It is required when 2 or more external input and output ports are used.

## Dimensions

(Unit: mm)

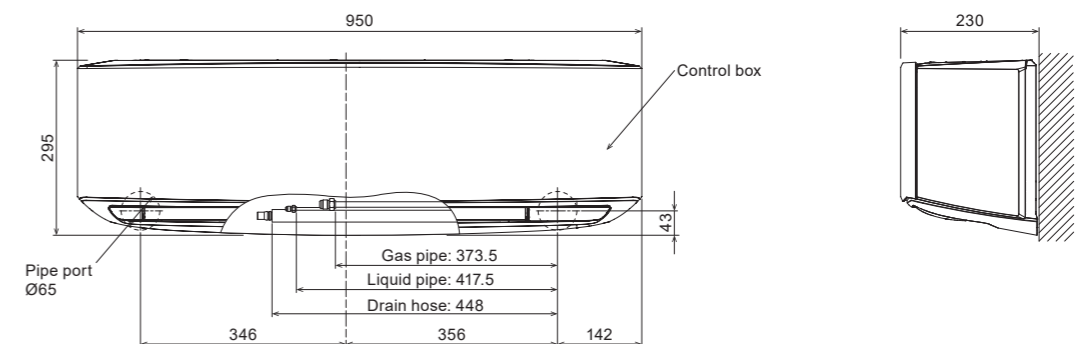



# Wall-mounted type

Built-in WLAN adapter model  
Standard Range  
High-Efficiency & Comfort

KM Series



## Slim & stylish square design

The slim and stylish square design of this indoor unit is realized by using a high-density, multipath heat exchanger and a high-efficiency wind blower.

### Hybrid-heat exchanger

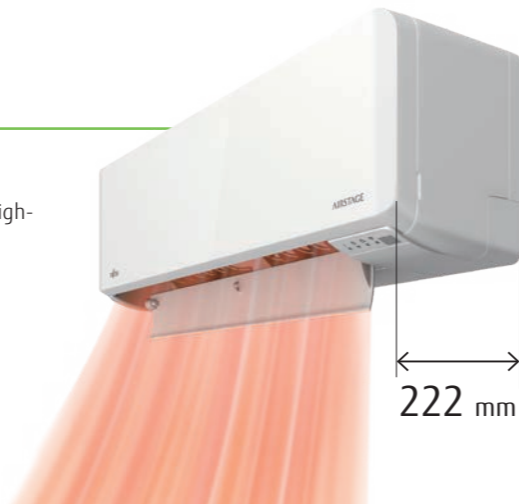
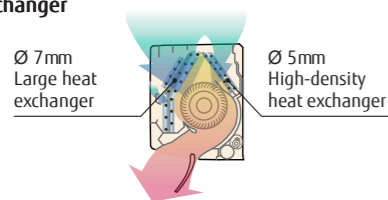

## High energy saving

High-efficiency has been achieved by the lambda-shaped heat exchanger, large cross-flow fan, and the new refrigerant.

Rank Cooling A++ Heating A++\*

SEER 8.40\* SCOP 4.60\*

\*07/09/12 models

## Comfortable airflow & Quiet operation

The large louver and the new air-blowing structure create a comfortable air flow that spreads all the way down to the user's feet with quiet operation.



## Smart device control

A WLAN adapter is included as standard equipment. By installing the AIRSTAGE mobile app on your smart device, you can check and control the operating status of the air conditioner from anywhere indoors or outdoors.

\* See page C-020 for details on smart device control.



## Refrigerant cycle monitor (Option)

Wired Remote Controller (Touch Panel) will support to display some sensor values for maintenance and service support.

\*Wired remote controller (UTY-RNRY25 or UTY-RVRY) is required.

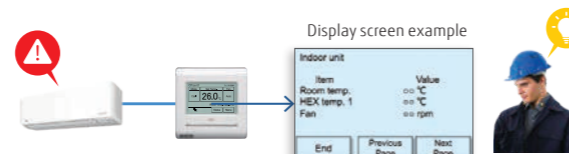

Model: ASEH07KMCG / ASEH09KMCG / ASEH12KMCG / ASEH14KMCG



## Specifications

Model name	Indoor unit		ASEH07KMCG	ASEH09KMCG	ASEH12KMCG	ASEH14KMCG
	Outdoor unit		AOEH07KMCG	AOEH09KMCG	AOEH12KMCG	AOEH14KMCG
Power Source	Single phase, ~230 V, 50 Hz					
Capacity	Cooling	Rated	2.0	2.5	3.4	4.2
		Min.-Max.	0.9-3.0	0.9-3.2	0.9-3.9	0.9-4.4
	Heating	Rated	2.5	2.8	4.0	5.4
Min.-Max.		0.9-3.4	0.9-4.0	0.9-5.3	0.9-6.0	
Input Power	Cooling/Heating	kW	0.450 / 0.555	0.650 / 0.620	0.960 / 1.020	1.220 / 1.410
EER	Cooling	W/W	4.43	3.85	3.54	3.44
	Heating	W/W	4.52	4.52	3.92	3.83
Pdesign	Cooling/Heating (-10°C)	kW	2.0 / 2.3	2.5 / 2.4	3.4 / 2.5	4.2 / 4.0
SEER	Cooling	W/W	8.40	8.40	7.70	7.10
	Heating (Average)	W/W	4.60	4.60	4.60	4.10
Energy Efficiency Class	Cooling		A++	A++	A++	A++
	Heating (Average)		A++	A++	A++	A+
Max. Operating Current	Cooling/Heating	A	6.5 / 9.0	6.5 / 9.0	6.5 / 9.0	6.5 / 9.0
Annual Energy Consumption	Cooling	kWh/a	83	104	155	207
	Heating	kWh/a	700	730	761	1,366
Moisture Removal		l/h	1.0	1.3	1.8	2.1
	Indoor (Cooling)	H/M/L/Q	38 / 33 / 29 / 20	40 / 34 / 29 / 20	40 / 35 / 30 / 20	43 / 36 / 30 / 20
Sound Pressure Level	Indoor (Heating)	H/M/L/Q	41 / 35 / 31 / 22	42 / 36 / 31 / 22	42 / 38 / 33 / 22	44 / 39 / 33 / 24
	Outdoor (Cooling/Heating)	High	46 / 46	46 / 46	50 / 50	50 / 50
Sound Power Level	Indoor (Cooling/Heating)	High	54 / 56	55 / 57	55 / 58	57 / 59
	Outdoor (Cooling/Heating)	High	61 / 61	61 / 62	65 / 65	65 / 66
Airflow Rate	Indoor/Outdoor (Cooling)	High	650 / 1,650	700 / 1,650	700 / 1,700	770 / 1,680
	Indoor/Outdoor (Heating)	High	720 / 1,450	750 / 1,450	780 / 1,470	820 / 1,580
Net Dimensions H x W x D	Indoor	mm	270 x 834 x 222	270 x 834 x 222	270 x 834 x 222	270 x 834 x 222
	Outdoor	mm	541 x 663 x 290	541 x 663 x 290	541 x 663 x 290	542 x 799 x 290
Weight	Indoor	kg	10	10	10	10
	Outdoor	kg	22	22	24	31
Connection Pipe Diameter (Liquid/Gas)		mm	6.35 / 9.52	6.35 / 9.52	6.35 / 9.52	6.35 / 9.52
Drain Hose Diameter (I.D./O.D.)		mm	13.8 / 15 to 16.8	13.8 / 15 to 16.8	13.8 / 15 to 16.8	13.8 / 15 to 16.8
Max. Pipe Length (Pre-Charge)		m	20 (15)	20 (15)	20 (15)	20 (15)
Max. Height Difference		m	15	15	15	15
		m	-10 to 50	-10 to 50	-10 to 50	-10 to 50
Operating Range	Cooling	°CDB	-10 to 50	-10 to 50	-10 to 50	-10 to 50
	Heating	°CDB	-15 to 24	-15 to 24	-15 to 24	-15 to 24
Refrigerant	Type (Global Warming Potential)		R32 (675)	R32 (675)	R32 (675)	R32 (675)
	Charge	kg (CO2eq-T)	0.60 (0.405)	0.60 (0.405)	0.70 (0.473)	0.85 (0.574)

## Optional parts

\* For optional parts compatibility of Intesis devices, please refer to the optional parts compatibility list page C-050 to C-053 and C-066.

Wired Remote Controller (Design type): UTY-RVRY	Simple remote controller: UTY-RSRY	Network Converter for single split (DC power supply type): UTY-VTGX
Compact wired remote controller: UTY-RCRYZ1	Communication kit: UTY-TWRXZ2	Network Converter for single split (AC power supply type): UTY-VTGXV
Wired remote controller (touch panel): UTY-RNRYZ5	External connect kit: UTY-XWZX	Silver Ion filter: UTR-FA16-5
Wired remote controller: UTY-RLRY	External switch controller: UTY-XWZX5	External input and output PCB*: UTY-XCSXZ2
Simple remote controller (without operation mode): UTY-RHRY		

\*1 It is required when 2 or more external input and output ports are used.

## Dimensions

(Unit: mm)

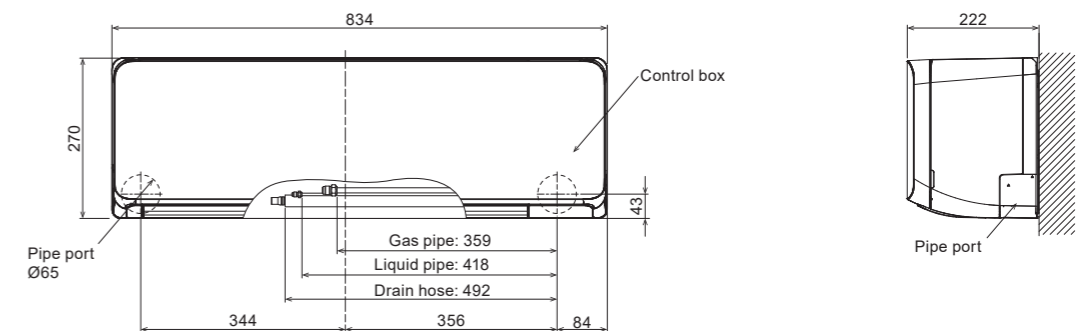



# Wall-mounted type

Built-in WLAN adapter model  
ECO Range  
Compact Size



## Elegant & smart square design

An elegant and smart type in the eco range. The delicate shading of the ridge line makes the unit an accessory for the room.



## High energy saving

The size of the heat exchanger has increased to improve performance, making it more powerful despite its compact size.

Rank Cooling A++ Heating A+

SEER 7.8\* SCOP 4.4

\* 07 model

## Comfortable airflow & Quiet operation

The large louver and the new air-blowing structure create a comfortable air flow that spreads all the way down to the user's feet with quiet operation.

Quiet & Comfort

20 dB(A)  
Cooling only

## Smart device control

A WLAN adapter is included as standard equipment. By installing the AIRSTAGE mobile app on your smart device, you can check and control the operating status of the air conditioner from anywhere indoors or outdoors.

\* See page C-020 for details on smart device control.

AIRSTAGE Mobile

"ON" before returning home.

## Highly efficient operation even at high outdoor temperatures

Even when installed in areas with high outdoor air temperatures (Max. 50°C\*), it is comfortable because it can cool the interior well.

\* suction temperature of the outdoor unit

Operation Range MAX 50°C (Cooling operation)

Model: ASEH07KNCA / ASEH09KNCA / ASEH12KNCA



WLAN adapter (Built-in)



Wireless RC

AR-RPF4E



## Specifications

Model name	Indoor unit		ASEH07KNCA	ASEH09KNCA	ASEH12KNCA
	Outdoor unit		AOEH07KNCA	AOEH09KNCA	AOEH12KNCA
Power Source	Single phase, ~230 V, 50 Hz				
Capacity	Cooling	Rated	2.0	2.5	3.4
		Min.-Max.	0.9-2.9	0.9-3.1	0.9-3.8
	Heating	Rated	2.5	2.8	3.8
Min.-Max.		0.9-3.4	0.9-4.0	0.9-4.8	
Input Power	Cooling/Heating	kW	0.50 / 0.58	0.74 / 0.70	1.05 / 1.02
EER	Cooling	W/W	4.00	3.38	3.24
COP	Heating	W/W	4.31	4.00	3.73
Pdesign	Cooling/Heating (-10°C)	kW	2.0 / 2.3	2.5 / 2.4	3.4 / 2.5
SEER	Cooling	W/W	7.8	7.4	7.0
SCOP	Heating (Average)	W/W	4.4	4.4	4.4
Energy Efficiency Class	Cooling		A++	A++	A++
	Heating (Average)		A+	A+	A+
Max. Operating Current	Cooling/Heating	A	6.5 / 9.0	6.5 / 9.0	6.5 / 9.0
Annual Energy Consumption	Cooling	kWh/a	90	118	170
	Heating	kWh/a	731	763	795
Moisture Removal		l/h	1.0	1.0	1.4
Sound Pressure Level	Indoor (Cooling)	H/M/L/Q	36 / 33 / 29 / 20	38 / 35 / 29 / 20	40 / 36 / 32 / 20
	Indoor (Heating)	H/M/L/Q	38 / 33 / 30 / 22	38 / 33 / 30 / 22	39 / 35 / 31 / 22
Sound Power Level	Outdoor (Cooling/Heating)	High	43 / 44	44 / 45	49 / 49
	Indoor (Cooling/Heating)	High	51 / 52	53 / 52	55 / 53
Airflow Rate	Indoor/Outdoor (Cooling)	High	530 / 1,430	580 / 1,430	600 / 1,460
	Indoor/Outdoor (Heating)	High	580 / 1,390	580 / 1,390	600 / 1,360
Net Dimensions H x W x D	Indoor	mm	270 x 784 x 222	270 x 784 x 222	270 x 784 x 222
	Outdoor	mm	541 x 663 x 290	541 x 663 x 290	541 x 663 x 290
Weight	Indoor	kg	9	9	9
	Outdoor	kg	22	22	24
Connection Pipe Diameter (Liquid/Gas)		mm	6.35 / 9.52	6.35 / 9.52	6.35 / 9.52
Drain Hose Diameter (I.D./O.D.)		mm	13.8 / 15 to 16.8	13.8 / 15 to 16.8	13.8 / 15 to 16.8
Max. Pipe Length (Pre-Charge)		m	20 (15)	20 (15)	20 (15)
Max. Height Difference		m	15	15	15
Operating Range	Cooling	°CDB	-10 to 50	-10 to 50	-10 to 50
	Heating	°CDB	-15 to 24	-15 to 24	-15 to 24
Refrigerant	Type (Global Warming Potential)		R32 (675)	R32 (675)	R32 (675)
	Charge	kg (CO2eq-T)	0.57 (0.385)	0.57 (0.385)	0.65 (0.439)

## Optional parts

\* For optional parts compatibility of Intesis devices, please refer to the optional parts compatibility list page C-050 to C-053 and C-066.

Silver Ion Filter: UTR-FA16-5

## Dimensions

(Unit: mm)

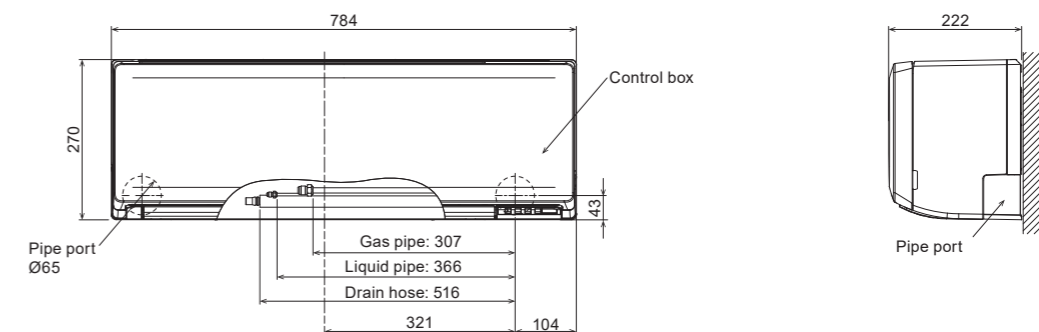

# Wall-mounted type

## Standard Range

High-Efficiency & Large Rooms



KM Series



### High energy saving

High-efficiency has been achieved by the lambda-shaped heat exchanger, large cross-flow fan, and the new refrigerant.

Rank **A++**  
 SEER **7.8**  
 SCOP **4.6**  
\*18 model

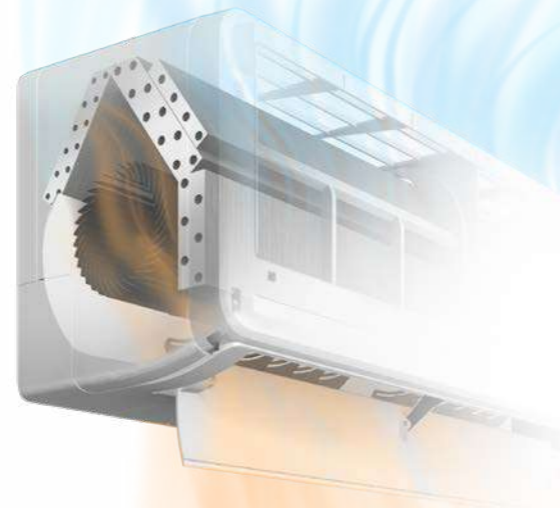

#### Hybrid-heat exchanger

The large hybrid heat exchanger has greatly improved the heat exchange efficiency to achieve top-level SEER and SCOP.

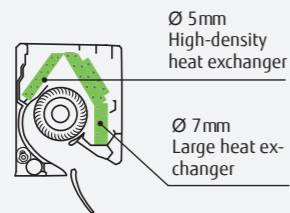

#### Ø107 Large cross-flow fan

The large-diameter fan generates air volume efficiently even at reduced power.

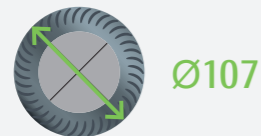

### Smart device control (Option)

With the optional WLAN adapter installed in the air conditioner, you can control it from anywhere with your smart device.

\* For more information about smart device control, please refer to the page C-020.



AIRSTAGE Mobile

You need to install the AIRSTAGE Mobile app on your smart device in order to control the air conditioner.



WLAN adapter (USB)



### Easy access to the flare pipe connection

Installation when left outlet piping is easier by removable under cover of the indoor unit chassis. Installation when center outlet piping is easier by design change of wall hook bracket.

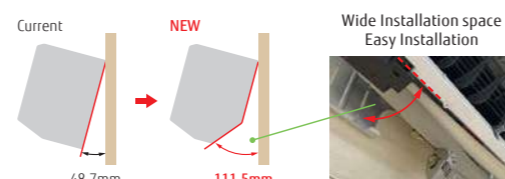

Model: ASEG18KMTE / ASEG24KMTE



For ASEG18KMTE



For ASEG24KMTE

### Specifications

Model name	Indoor unit		Outdoor unit		ASEG18KMTE	ASEG24KMTE	
	AOEG18KMTA		AOEG24KMTA				
Power Source	Single phase, ~230 V, 50 Hz						
Capacity	Cooling	Rated	kW	5.2		7.1	
		Min.-Max.		0.9-6.0		0.9-8.3	
	Heating	Rated	kW	6.3		8.0	
Min.-Max.		0.9-8.7		0.9-10.1			
Input Power	Cooling/Heating		kW	1.39/1.56		2.08/1.91	
EER	Cooling			3.74		3.41	
				4.04		4.19	
COP	Heating			5.2/4.8		7.1/7.1	
				7.77		7.30	
Pdesign	Cooling/Heating (-10°C)		kW	4.60		4.20	
SEER	Cooling		W/W	A++		A++	
SCOP	Heating (Average)		W/W	A++		A+	
Energy Efficiency Class	Cooling			9.5/13.5		13.5/16.0	
Max. Operating Current	Cooling/Heating			234		340	
				1,460		2,362	
Annual Energy Consumption	Cooling		kWh/a	1.7		2.7	
Moisture Removal	Heating			45/40/35/29		49/40/35/29	
				46/40/35/29		49/40/35/29	
Sound Pressure Level	Indoor (Cooling)	H/M/L/Q	dB(A)	50/50		54/52	
				60/61		65/65	
				65/65		67/66	
Sound Power Level	Indoor (Cooling/Heating)	High	m³/h	980/2,350		1,170/3,240	
				1,020/2,100		1,170/2,820	
Airflow Rate	Indoor/Outdoor (Cooling)	High	mm	280 × 980 × 240		280 × 980 × 240	
				632 × 799 × 290		716 × 820 × 315	
Net Dimensions H x W x D	Indoor			12.5		12.5	
				36		42	
Weight	Outdoor			6.35/12.70		6.35/12.70	
				13.8/15.8 to 16.7		13.8/15.8 to 16.7	
Connection Pipe Diameter (Liquid/Gas)			mm	25 (15)		30 (15)	
Drain Hose Diameter (I.D./O.D.)			m	-10 to 46		-10 to 46	
Max. Pipe Length (Pre-Charge)			°CDB	-15 to 24		-15 to 24	
Max. Height Difference	Cooling		kg (CO2eq-T)	R32 (675)		R32 (675)	
Operating Range	Heating			1.02 (0.689)		1.32 (0.891)	
Refrigerant	Type (Global Warming Potential)						
Charge							

### Optional parts

\* For optional parts compatibility of Intesis devices, please refer to the optional parts compatibility list page C-050 to C-053 and C-066.

Wired Remote Controller (Design type):	UTY-RVRY	External connect kit:	UTY-XWZX25	Network Converter for single split (DC power supply type):	UTY-VTGX
Compact wired remote controller:	UTY-RCRYZ1	Communication kit:	UTY-TWRXZ2	Network Converter for single split (AC power supply type):	UTY-VTGXV
Wired remote controller (touch panel):	UTY-RNRYZ5	External input and output PCB*1:	UTY-XCSXZ2	Silver Ion filter:	UTR-FA16-5
Wired remote controller:	UTY-RLRY	WLAN adapter:	UTY-TFSXF2	External switch controller:	UTY-TERX
Simple remote controller (without operation mode):	UTY-RHRY		UTY-TFSXH3		
Simple remote controller:	UTY-RSRY		FG-AC-WIF1Z1		

\*1 It is required when 2 or more external input and output ports are used.

### Dimensions

(Unit: mm)

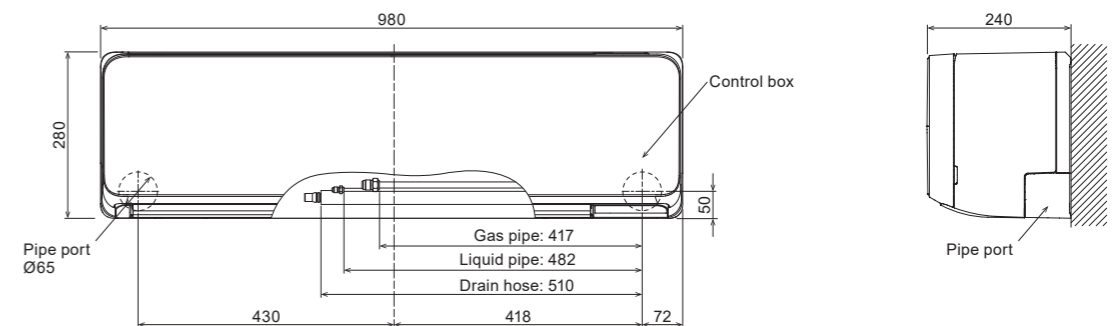



# Wall-mounted type

## Standard Range

High-Efficiency & Large Rooms



KM Series



### Special Cooling

When it is necessary to be constantly cooled such as rooms with a high heat load, it is possible to operate the cooling with keeping performance even when the outside temperature is low.

- \*Wired remote controller (UTY-RNRYZ5) is required.
- \*Please note that we will not provide compensation for any damages suffered to your appliances or data as a result of using this function.
- \*Please use it in low-humidity environments.
- Condensation and other problems may be caused when used in high-humidity environments.

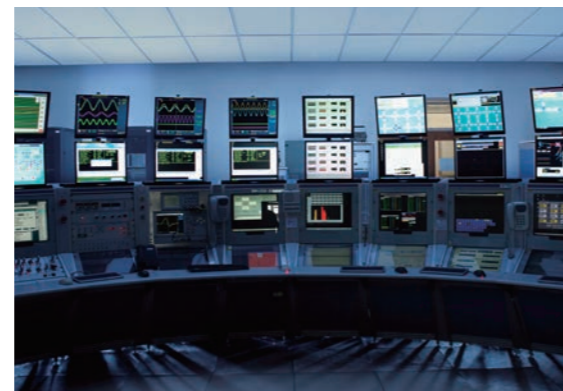

### Human sensor

The Human sensor monitors the movements of people in a room and operates the air conditioner at a lower capacity when people leave the room. When people come back to the room, it automatically returns to the previous operating mode.

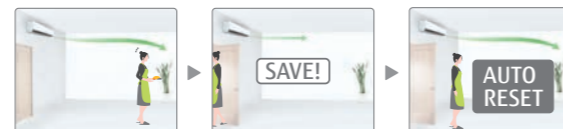

### Refrigerant cycle monitor (Option)

Wired Remote Controller (Touch Panel) will support to display some sensor values for maintenance and service support.

\*Wired remote controller (UTY-RNRYZ5 or UTY-RVRY) is required.

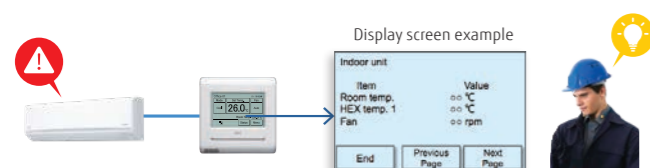

### Smart device control (Option)

With the optional WLAN adapter installed in the air conditioner, you can control it from anywhere with your smart device.

\* For more information about smart device control, please refer to the page C-020.



### Model: ASEH30KMTB / ASEH36KMTB



Wireless RC



### Specifications

Model name	Indoor unit		AOEH30KMTB		ASEH36KMTB	
	Outdoor unit		AOEH30KMTB		AOEH36KMTB	
Power Source			Single phase, ~230V, 50Hz			
Capacity	Cooling	Rated	8.0		9.4	
		Min.-Max.	2.9-9.0		2.9-10.0	
	Heating	Rated	8.8		10.1	
Min.-Max.		2.2-11.8		2.7-12.6		
Input Power	Cooling/Heating		kW		2.33/2.20	
EER	Cooling		W/W		3.43	
COP	Heating		W/W		4.00	
Pdesign	Cooling/Heating (-10°C)		kW		8.0/6.5	
SEER	Cooling		W/W		6.68	
SCOP	Heating (Average)		W/W		4.50	
Energy Efficiency Class	Cooling		A++		A++	
	Heating (Average)		A+		A+	
Max. Operating Current	Cooling/Heating		A		21.0/21.0	
Annual Energy Consumption	Cooling		kWh/a		419	
	Heating		kWh/a		1,994	
Moisture Removal	Cooling		l/h		2.6	
	Heating		l/h		50/44/40/33	
Sound Pressure Level	Indoor (Cooling)	H/M/L/Q	dB(A)		50/44/39/33	
	Indoor (Heating)	H/M/L/Q	dB(A)		49/44/39/33	
Sound Power Level	Outdoor (Cooling/Heating)	High	dB(A)		53/55	
	Indoor (Cooling/Heating)	High	dB(A)		65/65	
Airflow Rate	Indoor/Outdoor (Cooling)	High	m³/h		1,330/3,750	
	Indoor/Outdoor (Heating)	High	m³/h		1,330/3,750	
Net Dimensions	Indoor	mm	340 × 1,150 × 280		340 × 1,150 × 280	
	Outdoor	mm	788 × 940 × 320		788 × 940 × 320	
Weight	Indoor	kg	18.5		18.5	
	Outdoor	kg	52.0		52.0	
Connection Pipe Diameter (Liquid/Gas)	mm		9.52/15.88		9.52/15.88	
Drain Hose Diameter (I.D./O.D.)	mm		13.8/15.8 to 16.7		13.8/15.8 to 16.7	
Max. Pipe Length (Pre-Charge)	m		50(30)		50(30)	
Max. Height Difference	m		30		30	
Operating Range	Cooling	°CDB	-15to46		-15to46	
	Heating	°CDB	-15to24		-15to24	
Refrigerant	Type (Global Warming Potential)	R32(675)		R32(675)		
	Charge	kg (CO2eq-T)	1.90(1.283)		1.90(1.283)	

### Optional parts

\* For optional parts compatibility of Intesis devices, please refer to the optional parts compatibility list page C-050 to C-053 and C-066.

- |  |            |                                  |              |  |            |
|--|------------|----------------------------------|--------------|--|------------|
| Wired Remote Controller (Design type):             | UTY-RVRY   | External connect kit:            | UTY-XWZX25   | Network Converter for single split (DC power supply type): | UTY-VTGX   |
| Compact wired remote controller:                   | UTY-RCRYZ1 | Communication kit:               | UTY-TWRXZ2   | Network Converter for single split (AC power supply type): | UTY-VTGXV  |
| Wired remote controller (touch panel):             | UTY-RNRYZ5 | External input and output PCB*1: | UTY-XCSXZ2   | Silver Ion Filter:   | UTR-FA13-3 |
| Wired remote controller:                           | UTY-RLRY   | WLAN adapter:                    | UTY-TFSXF2   | External switch controller:                                | UTY-TERX   |
| Simple remote controller (without operation mode): | UTY-RHRY   |                                  | UTY-TFSXH3   |  |            |
| Simple remote controller:                          | UTY-RSRY   |                                  | FG-AC-WIF1Z1 |  |            |

\*1 It is required when 2 or more external input and output ports are used.

### Dimensions

(Unit: mm)

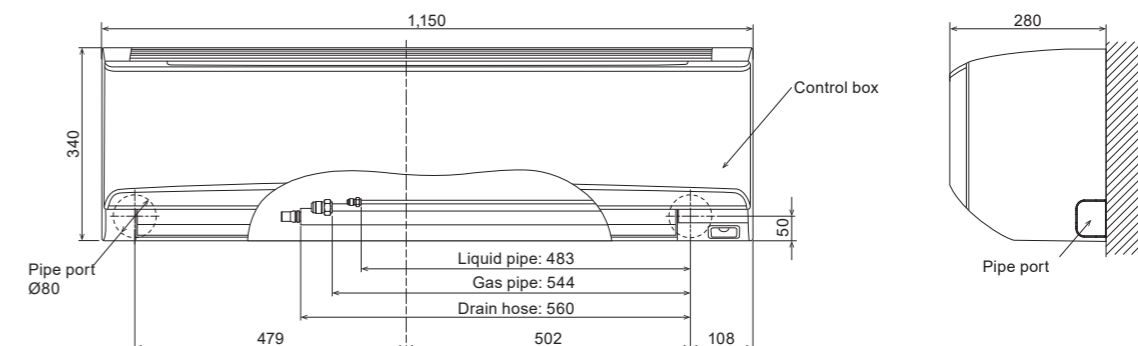



Wall-mounted type  
ECO Range  
Compact Size

KP Series



Slim & stylish square design

The slim and stylish square design of this indoor unit is realized by using a high-density, multipath heat exchanger and a high-efficiency wind blower.



High energy saving

High-efficiency has been achieved by the lambda-shaped heat exchanger, large cross-flow fan, and the new refrigerant.

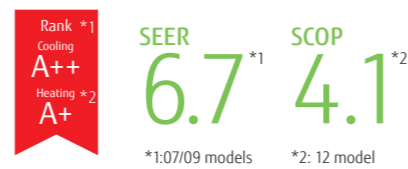

Comfortable airflow & Quiet operation

The large louver and the new air-blowing structure create a comfortable air flow that spreads all the way down to the user's feet with quiet operation.



Smart device control (Option)

With the optional WLAN adapter installed in the air conditioner, you can control it from anywhere with your smart device.

\* For more information about smart device control, please refer to the page C-020.



Easy access to the flare pipe connection

Installation when left outlet piping is easier by removable under cover of the indoor unit chassis. Installation when center outlet piping is easier by design change of wall hook bracket.

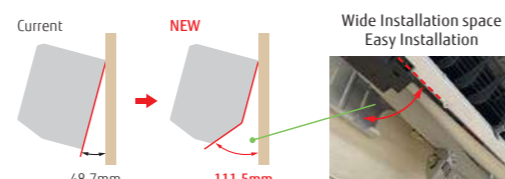

Model: ASEG07KPCE / ASEG09KPCE / ASEG12KPCE



Specifications

Model name	Indoor unit		Outdoor unit		ASEG07KPCE	ASEG09KPCE	ASEG12KPCE	
	AOEG07KPCE		AOEG09KPCE		AOEG07KPCE	AOEG09KPCE	AOEG12KPCE	
Power Source	Single phase, ~230 V, 50 Hz							
Capacity	Cooling	Rated	kW	2.0		2.5		
		Min.-Max.		0.9-2.8		0.9-3.0		
	Heating	Rated		2.5		2.8		3.8
Min.-Max.		0.9-3.4		0.9-3.8		0.9-4.8		
Input Power	Cooling/Heating		kW	0.48/0.63		0.71/0.79		
EER	Cooling			4.17		3.52		
COP	Heating		W/W	3.97		3.54		
Pdesign	Cooling/Heating (-10°C)		kW	2.0/2.2		2.5/2.4		
SEER	Cooling		W/W	6.70		6.70		
SCOP	Heating (Average)		W/W	4.00		4.00		
Energy Efficiency Class	Cooling			A++		A++		
	Heating (Average)			A+		A+		
Max. Operating Current	Cooling/Heating		A	6.5/9.0		6.5/9.0		
Annual Energy Consumption	Cooling		kWh/a	104		131		
	Heating			769		840		
Moisture Removal			l/h	1.0		1.3		
Sound Pressure Level	Indoor (Cooling)	H/M/L/Q	dB(A)	45/38/31/22		45/38/31/22		
	Indoor (Heating)	H/M/L/Q		45/40/36/26		46/40/35/27		
Sound Power Level	Outdoor (Cooling/Heating)	High	dB(A)	45/46		47/47		
	Indoor (Cooling/Heating)	High		57/58		59/59		
	Outdoor (Cooling/Heating)	High		57/58		59/59		
	Indoor/Outdoor (Cooling)	High		580/1,650		630/1,700		
Airflow Rate	Indoor/Outdoor (Heating)	High	m³/h	580/1,450		580/1,450		
Net Dimensions H x W x D	Indoor	mm	270 x 784 x 224		270 x 784 x 224		270 x 784 x 224	
	Outdoor	mm	541 x 663 x 290		541 x 663 x 290		541 x 663 x 290	
Weight	Indoor	kg	8		8		8	
	Outdoor	kg	23		23		25	
Connection Pipe Diameter (Liquid/Gas)			mm	6.35/9.52		6.35/9.52		
Drain Hose Diameter (I.D./O.D.)			mm	11.8/15.0 to 16.8		11.8/15.0 to 16.8		
Max. Pipe Length (Pre-Charge)			m	20 (15)		20 (15)		
Max. Height Difference			m	15		15		
Operating Range	Cooling	°CDB	-10 to 46		-10 to 46		-10 to 46	
	Heating		-15 to 24		-15 to 24		-15 to 24	
Refrigerant	Type (Global Warming Potential)			R32 (675)		R32 (675)		
	Charge		kg (CO2eq-T)	0.55 (0.371)		0.55 (0.371)		

Optional parts

\* For optional parts compatibility of Intesis devices, please refer to the optional parts compatibility list page C-050 to C-053 and C-066.

- WLAN adapter: UTY-TFSXF2, UTY-TFSXH3
- Silver Ion Filter: UTR-FA16-5

Dimensions

(Unit: mm)

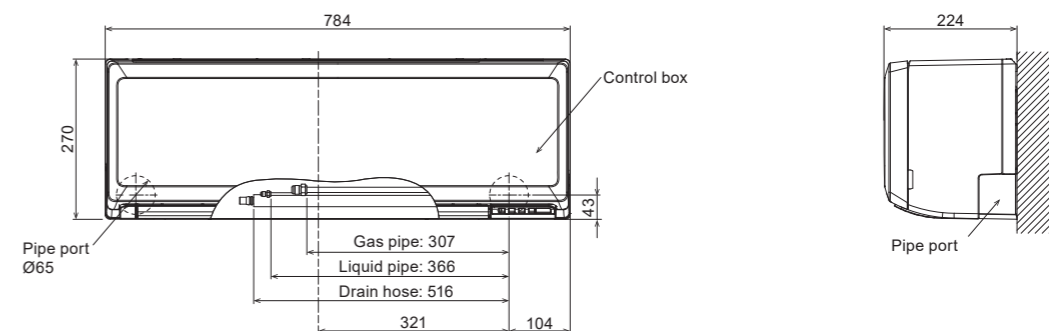

# Wall-mounted type

## ECO Range

Comfort for Large Rooms



KL Series



### Narrow width & Compact design

Compact and versatile. Powerful airflow is realized despite the 790-mm width compact design for small spaces such as bedrooms or home offices.



### Economy operation

Set temperature automatically increases or decreases by 1°C. The thermostat setting is adjusted automatically according to the room temperature to avoid unnecessary cooling or heating.

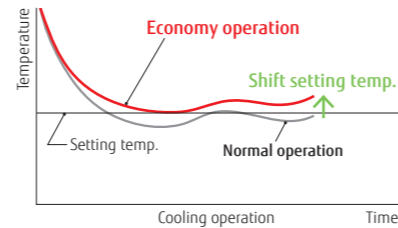

### Powerful operation

In powerful operation mode, the compressor operates at maximum speed for 20 minutes to provide a powerful airflow. Rapid cooling and heating makes the room comfortable quickly.

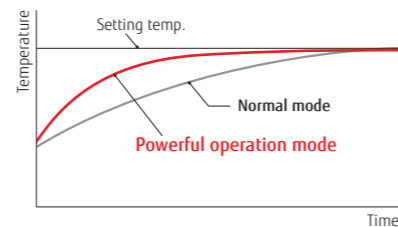

### ON-OFF programmable timer

You can set ON/OFF or OFF/ON times depending on your lifestyle needs. (Setting time: 0.5, 1, 1.5, 2, 2.5, -----9.5, 10, 11, 12 hours)

### Low ambient operation

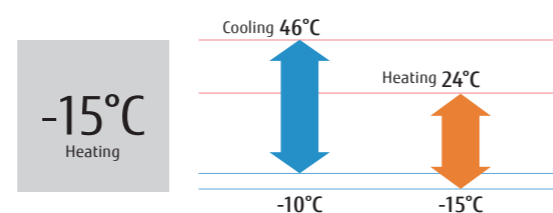

Model: ASEG18KLCA / ASEG24KLCA



Wireless RC



For ASEG18KLCA

For ASEG24KLCA

### Specifications

Model name	Indoor unit		Outdoor unit		ASEG18KLCA	ASEG24KLCA
	AOEG18KLCA		AOEG24KLCA			
Power Source	Single phase, ~230 V, 50 Hz					
Capacity	Cooling	Rated	kW	5.2		7.1
		Min.-Max.		0.9-5.5		0.9-7.7
	Heating	Rated	6.3		8.0	
Min.-Max.		0.6-7.6		0.9-9.0		
Input Power	Cooling/Heating		kW	1.685/1.80		2.42/2.225
EER	Cooling			3.09		2.93
		Heating		3.50		3.60
COP	Cooling/Heating (-10°C)			5.20/4.80		7.10/7.10
		Cooling		7.20		7.10
SEER	Heating (Average)			4.30		4.00
		Cooling		A++		A++
Energy Efficiency Class	Heating (Average)				A+	
	Cooling/Heating		A	9.5/13.5		13.5/17.5
Max. Operating Current	Cooling		kWh/a	253		350
	Heating			1563		2485
Annual Energy Consumption	Cooling		l/h	1.9		3.1
	Heating			47/44/40/35		51/45/38/33
Moisture Removal	Indoor (Cooling)		H/M/L/Q	50/45/41/37		52/45/41/37
	Indoor (Heating)		H/M/L/Q	50/56		55/57
Sound Pressure Level	Indoor (Cooling/Heating)		High	60/65		64/65
	Outdoor (Cooling/Heating)		High	61/66		65/67
Sound Power Level	Indoor (Cooling/Heating)		High	865/1,830		1,040/2,885
	Outdoor (Cooling/Heating)		High	995/2,265		1,040/3,030
Airflow Rate	Indoor		mm	293 × 790 × 249		293 × 790 × 249
	Outdoor		mm	542 × 799 × 290		632 × 799 × 290
Net Dimensions H x W x D	Indoor		kg	9.5		10.0
	Outdoor		kg	33		38
Weight	Connection Pipe Diameter (Liquid/Gas)		mm	6.35/9.52		6.35/12.70
	Drain Hose Diameter (I.D./O.D.)			13.8/15.8 to 16.7		13.8/15.8 to 16.7
Connection Pipe Diameter (Liquid/Gas)	Max. Pipe Length (Pre-Charge)		m	25 (15)		30 (15)
	Max. Height Difference			20		25
Operating Range	Cooling		°CDB	-10 to 46		-10 to 46
	Heating			-15 to 24		-15 to 24
Refrigerant	Type (Global Warming Potential)			R32 (675)		R32 (675)
	Charge		kg (CO2eq-T)	0.85 (0.574)		1.10 (0.743)

### Optional parts

\* For optional parts compatibility of Intesis devices, please refer to the optional parts compatibility list page C-050 to C-053 and C-066.

Silver Ion Filter: UTR-FA16-5

### Dimensions

(Unit: mm)

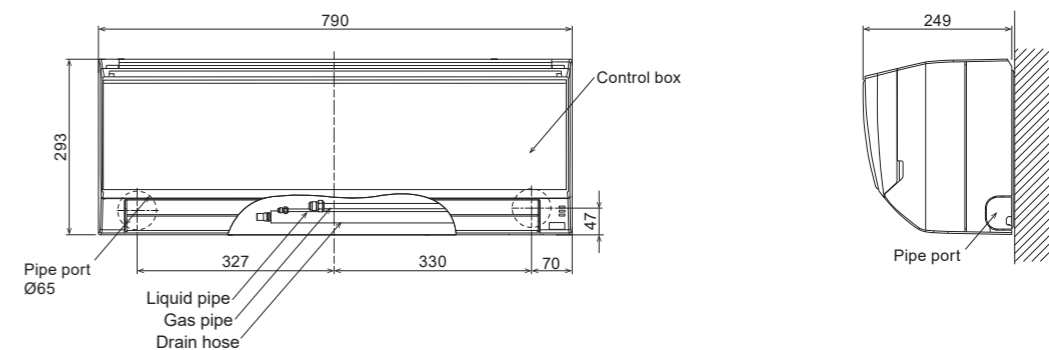

**Wall-mounted type**  
ECO Range  
Cooling-enhanced type

KL Series



**Highly efficient operation even at high outdoor temperatures**

Even when installed in areas with high outdoor air temperatures (Max. 52°C\*), it is comfortable because it can cool the interior well.

\*suction temperature of the outdoor unit

Rank **A++**  
SEER **7.1**\*  
Operation Range **MAX 52°C**  
\*07 model (Cooling operation)



**MINIMAL SMART design**

The new smart design eliminates mechanical elements and offers a sophisticated, premium impression. Its compact size, with a width of 770 mm, allows for flexible installation in limited room space.



**Comfortable airflow & Quiet operation**

The large louver and the new air-blowing structure create a comfortable air flow that spreads all the way down to the user's feet with quiet operation.



**Smart device control (Option)**

With the optional WLAN adapter installed in the air conditioner, you can control it from anywhere with your smart device.

\* For more information about smart device control, please refer to the page C-020.



Model: ASEH07KLTA / ASEH09KLTA / ASEH12KLTA

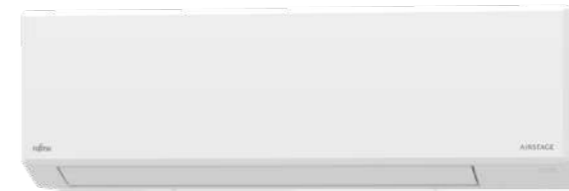

Wireless RC



**Specifications**

Model name	Indoor unit		ASEH07KLTA	ASEH09KLTA	ASEH12KLTA
	Outdoor unit		AOEH07KLTA	AOEH09KLTA	AOEH12KLTA
Power Source	Single phase, ~230 V, 50 Hz				
Capacity	Cooling	Rated	2.0	2.5	3.4
		Min.-Max.	0.9-2.8	0.9-3.0	0.9-3.7
	Heating	Rated	2.4	2.5	3.4
Min.-Max.		0.9-3.3	0.9-3.5	0.9-3.7	
Input Power	Cooling/Heating	kW	0.54 / 0.64	0.76 / 0.67	1.05 / 0.915
EER	Cooling		3.70	3.29	3.24
COP	Heating	W/W	3.75	3.73	3.72
Pdesign	Cooling/Heating (-10°C)	kW	2.0 / 2.2	2.5 / 2.3	3.4 / 2.5
SEER	Cooling	W/W	7.10	6.80	6.70
SCOP	Heating (Average)	W/W	4.10	4.10	4.10
Energy Efficiency Class	Cooling		A++	A++	A++
	Heating (Average)		A+	A+	A+
Max. Operating Current	Cooling/Heating	A	6.0 / 6.0	6.0 / 6.0	7.0 / 7.0
Annual Energy Consumption	Cooling	kWh/a	99	129	178
	Heating		752	786	854
Moisture Removal		l/h	0.18	0.55	1.26
Sound Pressure Level	Indoor (Cooling)	H/M/L/Q	41 / 36 / 29 / 21	43 / 36 / 29 / 21	43 / 37 / 30 / 21
	Indoor (Heating)	H/M/L/Q	41 / 37 / 32 / 23	43 / 37 / 32 / 23	43 / 37 / 32 / 23
Sound Power Level	Outdoor (Cooling/Heating)	High	47 / 47	47 / 47	50 / 50
	Indoor (Cooling/Heating)	High	54 / 55	55 / 55	55 / 56
Airflow Rate	Indoor/Outdoor (Cooling)	High	600 / 1,650	620 / 1,650	620 / 1,700
	Indoor/Outdoor (Heating)	High	600 / 1,450	620 / 1,450	640 / 1,470
Net Dimensions	Indoor	mm	250 × 770 × 218	250 × 770 × 218	250 × 770 × 218
	Outdoor	mm	541 × 663 × 290	541 × 663 × 290	541 × 663 × 290
Weight	Indoor	kg	7.0	7.0	7.5
	Outdoor	kg	19	19	22
Connection Pipe Diameter (Liquid/Gas)		mm	6.35 / 9.52	6.35 / 9.52	6.35 / 9.52
Drain Hose Diameter (I.D./O.D.)		mm	13.8 / 15 to 16.8	13.8 / 15 to 16.8	13.8 / 15 to 16.8
Max. Pipe Length (Pre-Charge)		m	20 (15)	20 (15)	20 (15)
Max. Height Difference			15	15	15
Operating Range	Cooling	°CDB	10 to 52	10 to 52	10 to 52
	Heating		-15 to 24	-15 to 24	-15 to 24
Refrigerant	Type (Global Warming Potential)		R32 (675)	R32 (675)	R32 (675)
	Charge	kg (CO2eq-T)	0.53(0.358)	0.53(0.358)	0.60(0.405)

**Optional parts**

\* For optional parts compatibility of Intesis devices, please refer to the optional parts compatibility list page C-050 to C-053 and C-066.

WLAN adapter: UTY-TFSXF2

UTY-TFSXH3

Silver Ion Filter: UTR-FA16-5

**Dimensions**

(Unit: mm)

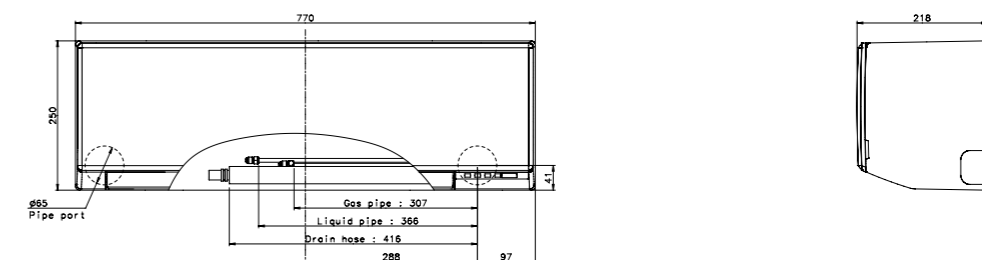



# Compact Cassette

Compact 4-way Flow Range  
Compact Size



Model: AUXG09KVLA / AUXG12KVLA / AUXG14KVLA / AUXG18KVLA / AUXG22KVLA / AUXG24KVLA



### Specifications

Model name	Indoor unit		AUXG09KVLA	AUXG12KVLA	AUXG14KVLA	AUXG18KVLA	AUXG22KVLA	AUXG24KVLA
	Outdoor unit		AOEG09KBTB	AOEG12KBTB	AOEG14KBTB	AOEG18KBTB	AOEG22KBTB	AOEG24KBTB
Power Source			Single phase, ~230 V, 50 Hz					
Capacity	Cooling	Rated	2.5	3.5	4.3	5.2	6.0	6.8
		Min.-Max.	0.9-3.2	0.9-4.4	0.9-5.4	0.9-5.9	0.9-6.7	0.9-8.0
	Heating	Rated	3.2	4.1	5.0	6.0	7.0	7.5
Min.-Max.		0.9-4.7	0.9-5.7	0.9-6.5	0.9-7.5	0.9-8.0	0.9-9.1	
EER	Cooling/Heating	kW	0.55/0.79	0.93/1.08	1.28/1.32	1.60/1.66	1.82/1.87	2.21/2.03
COP	Cooling	W/W	4.57	3.76	3.36	3.25	3.30	3.08
	Heating	W/W	4.05	3.80	3.79	3.61	3.74	3.69
Pdesign	Cooling/Heating (-10°C)	kW	2.5/2.6	3.5/3.4	4.3/3.8	5.2/4.4	6.0/4.8	6.8/6.0
SEER	Cooling	W/W	6.70	6.60	6.50	6.60	6.60	6.10
	Heating (Average)	W/W	4.40	4.30	4.40	4.20	4.30	4.00
Energy Efficiency Class	Cooling		A++	A++	A++	A++	A++	A++
	Heating (Average)		A+	A+	A+	A+	A+	A+
Max. Operating Current	Cooling/Heating	A	7.9/7.9	9.7/9.7	10.2/10.2	12.1/12.1	12.6/12.6	13.6/13.6
Annual Energy Consumption	Cooling	kWh/a	131	186	231	275	318	390
	Heating	kWh/a	826	1,106	1,208	1,466	1,562	2,097
Moisture Removal		l/h	0.6	1.2	1.5	2.2	2.6	2.7
Sound Pressure Level	Indoor (Cooling)	H/M/L/Q	33/31/29/27	37/34/30/27	38/34/30/27	38/34/30/26	44/42/36/30	49/44/36/30
	Indoor (Heating)	H/M/L/Q	34/32/29/27	37/34/31/29	43/38/34/30	43/38/34/30	45/43/40/33	49/45/40/33
Sound Power Level	Outdoor (Cooling/Heating)	High	46/46	47/47	49/49	50/50	51/51	53/54
	Indoor (Cooling/Heating)	High	46/47	49/49	50/55	50/55	56/57	59/61
	Outdoor (Cooling/Heating)	High	59/59	61/61	62/62	62/62	63/63	65/66
	Indoor/Outdoor (Cooling)	High	540/1,480	600/1,580	680/1,670	680/2,160	830/2,240	930/2,700
Airflow Rate	Indoor/Outdoor (Heating)	High	540/1,410	600/1,520	800/1,580	800/1,830	860/1,960	930/2,700
Net Dimensions H x W x D	Indoor	mm	245 × 570 × 570	245 × 570 × 570	245 × 570 × 570	245 × 570 × 570	245 × 570 × 570	245 × 570 × 570
	Outdoor	mm	542 × 799 × 290	542 × 799 × 290	542 × 799 × 290	632 × 799 × 290	632 × 799 × 290	716 × 820 × 315
Weight	Indoor	kg	15	15	15	15	16	16
	Outdoor	kg	32	33	33	36	38	42
Connection Pipe Diameter (Liquid/Gas)		mm	6.35/9.52	6.35/9.52	6.35/9.52	6.35/12.70	6.35/12.70	6.35/12.70
Drain Hose Diameter (I.D./O.D.)			25/32	25/32	25/32	25/32	25/32	25/32
Max. Pipe Length (Pre-Charge)		m	20 (15)	25 (15)	25 (15)	30 (20)	30 (20)	30 (20)
Max. Height Difference			15	20	20	20	25	25
Operating Range	Cooling	°CDB	-15 to 46	-15 to 46	-15 to 46	-15 to 46	-15 to 46	-15 to 46
	Heating	°CDB	-15 to 24	-15 to 24	-15 to 24	-15 to 24	-15 to 24	-15 to 24
Refrigerant	Type (Global Warming Potential)		R32 (675)	R32 (675)	R32 (675)	R32 (675)	R32 (675)	R32 (675)
	Charge	kg (CO2eq-T)	0.85 (0.574)	0.85 (0.574)	0.85 (0.574)	1.02 (0.689)	1.25 (0.844)	1.25 (0.844)
Cassette Grille	Model name		UTG-UFYF-W	UTG-UFYF-W	UTG-UFYF-W	UTG-UFYF-W	UTG-UFYF-W	UTG-UFYF-W
	Dimensions (H × W × D)	mm	49 × 620 × 620	49 × 620 × 620	49 × 620 × 620	49 × 620 × 620	49 × 620 × 620	49 × 620 × 620
	Weight	kg	2.3	2.3	2.3	2.3	2.3	

### Compact and stylish panel design

The compact and stylish panel fits nicely into a grid-type ceiling. Its linear design is a perfect fit into a grid of 620 mm × 620 mm in the ceiling.



### Easy maintenance

You can access the unit for maintenance simply by removing a ceiling panel next to the grille. As no inspection hole needs to be cut through the ceiling, no additional construction cost is incurred.

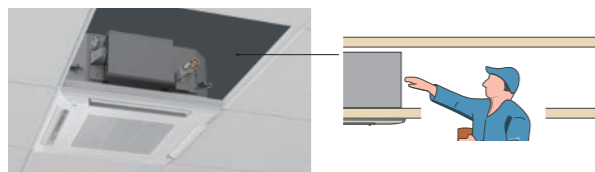

The air inlet grille can be installed to open in any direction for easy maintenance.



### Flexible installation

The unit fits nicely into the decor of a grid-type ceiling and can be installed near the lighting or a ventilation opening.



### Link up with a variety of central control system (Option)

Centralized control including facilities and equipment in addition to air conditioning is possible by linking up with MODBUS, KNX interfaces.



### Optional parts

\* For optional parts compatibility of Intesis devices, please refer to the optional parts compatibility list page C-050 to C-053 and C-066.

Wired Remote Controller (Design type): UTY-RVRY	Wireless remote controller: UTY-LNTY	Network Converter for single split (DC power supply type): UTY-VTGX
Compact wired remote controller: UTY-RCRYZ1	External switch controller: UTY-TERX	Network Converter for single split (AC power supply type): UTY-VTGXV
Wired remote controller (touch panel): UTY-RNRYZ5	WLAN adapter: UTY-TFSXZ1	Insulation kit for high humidity: UTZ-KXGC
Wired remote controller: UTY-RLRY	FG-RC-WIF1Z2	External input and output PCB: UTY-XCSX
UTY-RNNYM	UTY-TFSXJ3	External input and output PCB box: UTZ-GXRA
UTY-RVNYM	FG-AC-WIF1Z1	Silver Ion Filter: UTD-HFAA
Simple remote controller (without operation mode): UTY-RHRY	Air Outlet Shutter Plate: UTR-YDZB	Fresh air intake kit: UTZ-VXAA
Simple remote controller: UTY-RSRY	Cassette Grille: UTG-UFYF-W	External connect kit: UTY-XWZXZG

### Dimensions

(Unit: mm)

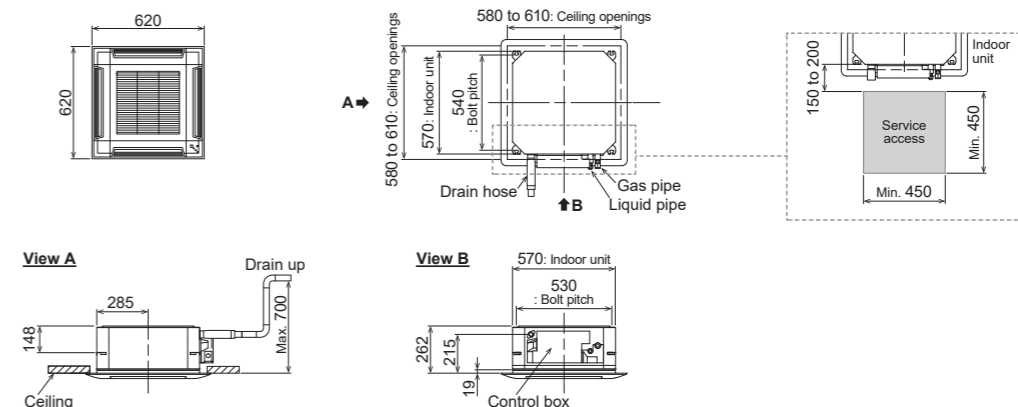

# Cassette

## Circular Flow Range

### Comfort for Large Rooms



### Unique circular flow design

The Cassette model realizes a Circular Flow to blow a large airflow in a 360° direction by using a high-performance DC fan motor, turbo fan, and a unique seamless airflow louver design.



Airflows avoid blowing cool air directly at the occupants in the room, providing more comfortable air conditioning. Provides efficient air conditioning based on the room layout

### Individual louver control

Each louver can be controlled individually with a wired remote controller equipped with a touch panel to provide different directional airflows according to the room layout.

\*Wired remote controller (touch panel) (UTY-RNRGZ3) only

**The Human sensor yields more energy savings.** Energy saving operation starts automatically by detecting the motion of a person. Two modes of save operation mode and stop mode can be selected.

### Compact and lightweight outdoor unit

The outdoor units for the 45,000 BTU and 54,000 BTU models have been completely redesigned. Easier installation is achieved for this compact and lightweight outdoor unit.

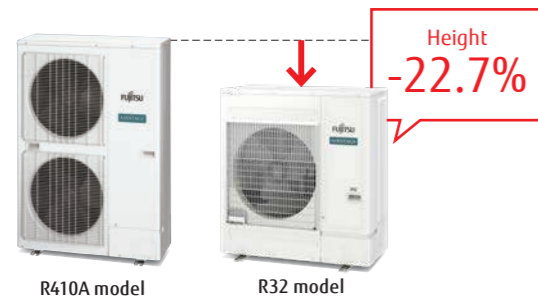

### Link up with a variety of central control system (Option)

Centralized control including facilities and equipment in addition to air conditioning is possible by linking up with MODBUS, KNX interfaces.



### Various cassette grilles

Both black and white grilles are available. Three types of grilles are available: a white grille with a remote controller; a white grille without a remote controller; and a black grille without a remote controller. Select to match the atmosphere and/or usage of the room.



Model: AUXG18KRLB / AUXG22KRLB / AUXG24KRLB / AUXG30KRLB / AUXG36KRLB / AUXG45KRLB / AUXG54KRLB  
AUXG36KRLB [3-phase] / AUXG45KRLB [3-phase] / AUXG54KRLB [3-phase]



### Specifications

Model name	Indoor unit								Outdoor unit			
	AUXG18KRLB	AUXG22KRLB	AUXG24KRLB	AUXG30KRLB	AUXG36KRLB	AUXG45KRLB	AUXG54KRLB	AUXG36KRLB	AUXG45KRLB	AUXG54KRLB		
Power Source	Single phase, ~230 V, 50 Hz								3-phase, ~400 V, 50 Hz			
Capacity	Cooling	Rated	5.2	6.0	6.8	8.5	9.5	12.1	13.4	9.5	12.1	13.4
		Min.-Max.	0.9-5.9	0.9-6.7	0.9-8.0	2.8-10.0	2.8-11.2	4.0-14.0	4.5-14.5	2.8-11.2	4.0-14.0	4.5-14.5
	Heating	Rated	6.0	7.0	7.5	10.0	10.8	13.5	15.5	10.8	13.5	15.5
		Min.-Max.	0.9-7.5	0.9-8.0	0.9-9.1	2.7-11.2	2.7-12.7	4.2-16.2	4.7-16.5	2.7-12.7	4.2-16.2	4.7-16.5
Input Power	Cooling/Heating	kW	1.36/1.58	1.71/1.82	1.89/1.90	2.44/2.51	2.91/2.45	3.61/3.21	4.41/4.16	2.91/2.45	3.61/3.21	4.41/4.16
EER	Cooling	W/W	3.82	3.51	3.60	3.49	3.26	3.35	3.04	3.26	3.35	3.04
COP	Heating	W/W	3.80	3.85	3.95	3.98	4.40	4.20	3.73	4.40	4.20	3.73
Pdesign	Cooling/Heating (-10°C)	kW	5.2/4.4	6.0/4.8	6.8/6.0	8.5/8.0	9.5/8.7	-	-	9.5/8.7	-	-
SEER	Cooling	W/W	7.00	7.00	6.60	6.70	6.55	-	-	6.55	-	-
SCOP	Heating (Average)	W/W	4.30	4.40	4.20	4.30	4.30	-	-	4.30	-	-
Energy Efficiency Class	Cooling		A++	A++	A++	A++	A++	-	-	A++	-	-
	Heating (Average)		A+	A+	A+	A+	A+	-	-	A+	-	-
Max. Operating Current	Cooling/Heating	A	12.1/12.1	12.6/12.6	13.6/13.6	22.6/22.6	22.6/22.6	28.5/28.5	28.5/28.5	10.5/10.5	14.0/14.0	14.0/14.0
Annual Energy Consumption	Cooling	kWh/a	260	300	360	444	507	-	-	507	-	-
	Heating	kWh/a	1,431	1,527	1,999	2,601	2,828	-	-	2,828	-	-
Moisture Removal		l/h	1.5	2.2	2.7	2.5	3.3	4.5	5.0	3.3	4.5	5.0
Sound Pressure Level	Indoor (Cooling)	H/M/L/Q	33/32/31/28	33/32/31/28	35/33/32/29	40/38/36/33	44/41/38/34	46/42/39/35	47/43/40/36	44/41/38/34	46/42/39/35	47/43/40/36
	Indoor (Heating)	H/M/L/Q	33/32/31/28	33/32/31/28	35/33/32/29	40/38/36/33	44/41/38/34	46/42/39/35	47/43/40/36	44/41/38/34	46/42/39/35	47/43/40/36
Sound Power Level	Outdoor (Cooling/Heating)	High	50/50	51/51	53/54	53/55	55/55	57/57	57/59	55/55	57/57	57/59
	Indoor (Cooling/Heating)	High	47/47	49/49	49/49	54/54	58/58	60/60	61/61	58/58	60/60	61/61
Airflow Rate	Indoor/Outdoor (Cooling)	High	1,050/2,160	1,050/2,240	1,150/2,700	1,600/3,750	1,870/3,750	2,000/4,450	2,100/4,450	1,870/3,750	2,000/4,450	2,100/4,450
	Indoor/Outdoor (Heating)	High	1,050/1,830	1,050/1,960	1,150/2,700	1,600/3,750	1,870/3,750	2,000/4,450	2,100/4,450	1,870/3,750	2,000/4,450	2,100/4,450
Net Dimensions H x W x D	Indoor	mm	246 × 840 × 840	246 × 840 × 840	246 × 840 × 840	288 × 840 × 840	288 × 840 × 840	288 × 840 × 840	288 × 840 × 840	288 × 840 × 840	288 × 840 × 840	288 × 840 × 840
	Outdoor	mm	632 × 799 × 290	632 × 799 × 290	716 × 820 × 315	788 × 940 × 320	788 × 940 × 320	998 × 940 × 320	998 × 940 × 320	788 × 940 × 320	998 × 940 × 320	998 × 940 × 320
Weight	Indoor	kg	23	23	24	29	29	29	29	29	29	29
	Outdoor	kg	36	38	42	52	52	67	67	53	67	67
Connection Pipe Diameter (Liquid/Gas)		mm	6.35/12.70	6.35/12.70	6.35/12.70	9.52/15.88	9.52/15.88	9.52/15.88	9.52/15.88	9.52/15.88	9.52/15.88	9.52/15.88
Drain Hose Diameter (I.D./O.D.)		mm	25/32	25/32	25/32	25/32	25/32	25/32	25/32	25/32	25/32	
Max. Pipe Length (Pre-Charge)		m	30 (20)	30 (20)	30 (20)	50 (30)	50 (30)	50 (30)	50 (30)	50 (30)	50 (30)	
Max. Height Difference		m	20	25	25	30	30	30	30	30	30	
Operating Range	Cooling	°CDB	-15 to 46	-15 to 46	-15 to 46	-15 to 46	-15 to 46	-15 to 46	-15 to 46	-15 to 46	-15 to 46	-15 to 46
	Heating	°CDB	-15 to 24	-15 to 24	-15 to 24	-15 to 24	-15 to 24	-15 to 24	-15 to 24	-15 to 24	-15 to 24	-15 to 24
Refrigerant	Type (Global Warming Potential)		R32 (675)	R32 (675)	R32 (675)	R32 (675)	R32 (675)	R32 (675)	R32 (675)	R32 (675)	R32 (675)	R32 (675)
	Charge	kg (CO2eq-T)	1.02 (0.689)	1.25 (0.844)	1.25 (0.844)	1.90 (1.283)	1.90 (1.283)	2.70 (1.823)	2.70 (1.823)	1.90 (1.283)	2.70 (1.823)	2.70 (1.823)
Cassette Grille	Variation		UTG-UKYA-W: White wired remote controller (touch panel) UTG-UKYC-W: White/UTG-UKYA-B*1: Black								UTG-UKYA-W: White wired remote controller (touch panel) UTG-UKYC-W: White/UTG-UKYA-B*1: Black	
	Dimensions (H × W × D)	mm	53 × 950 × 950	53 × 950 × 950	53 × 950 × 950	53 × 950 × 950	53 × 950 × 950	53 × 950 × 950	53 × 950 × 950	53 × 950 × 950	53 × 950 × 950	53 × 950 × 950
	Weight	kg	6.0	6.0	6.0	6.0	6.0	6.0	6.0	6.0	6.0	6.0

\*1: IR Receiver kit and Human sensor kit cannot be connected.

### Optional parts

\*For optional parts compatibility of Intesis devices, please refer to the optional parts compatibility list page C-050 to C-053 and C-066.

Wired Remote Controller (Design type):	UTY-RVRY	WLAN adapter:	UTY-TFSXZ1	Cassette Grille:	UTG-UKYA-B
Compact wired remote controller:	UTY-RCRYZ1		FG-RC-WIF1Z2		UTG-UKYA-W
Wired remote controller (touch panel):	UTY-RNRYZ5		UTY-TFSXJ3		UTG-UKYC-W
Wired remote controller:	UTY-RLRY		FG-AC-WIF1Z1	Network Converter for single split (DC power supply type):	UTY-VTGX
	UTY-RNNYM	External input and output PCB:	UTY-XCSX	Network Converter for single split (AC power supply type):	UTY-VTGV
	UTY-RVNYM	External input and output PCB box:	UTZ-GXRA	Silver Ion Filter:	UTD-HFRA
Simple remote controller (without operation mode):	UTY-RHRY	Insulation kit for high humidity:	UTZ-KXRA	External connect kit:	UTY-XWZXZG
Simple remote controller:	UTY-RSRY	Fresh air intake kit:	UTZ-VXRA		
Human sensor kit:	UTY-SHZXC	Wide Panel:	UTG-AKXA-W	(Outdoor unit 30/36/45/54)	
External switch controller:	UTY-TERX	Panel Spacer:	UTG-BKXA-W	External connect kit:	UTY-XWZXZ3
IR receiver unit:	UTY-LBITYC	Air Outlet Shutter Plate:	UTR-YDZK		

### Dimensions

(Unit: mm)

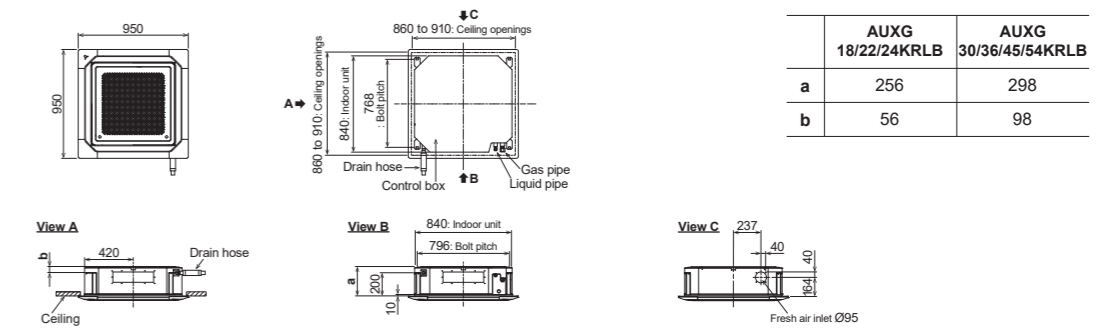

	AUXG 18/22/24KRLB	AUXG 30/36/45/54KRLB
a	256	298
b	56	98



## Slim Duct

Slim Design



### Slim design

The slim design fits nicely into narrow spaces under the ceiling. Drain hose as standard accessory



### Compact and lightweight outdoor unit

The compact and lightweight outdoor unit offers greater flexibility in the choice of installation location. This makes it easier to use this outdoor unit.



### Wide range of static pressures

The use of a DC fan motor makes it possible to adjust the static pressure between 0 and 90 Pa. The static pressure range can be changed by a remote controller.



Static pressure range  
0 to 90 Pa

### Auto louver grille kit (Option)

The optional clean-looking flat Auto louver blends into any interior and provides a comfortable airflow.



### Link up with a variety of central control system (Option)

Centralized control including facilities and equipment in addition to air conditioning is possible by linking up with MODBUS, KNX interfaces.



### Model: ARXG09KLLAP / ARXG12KLLAP / ARXG14KLLAP / ARXG18KLLAP



ARXG09/12/14KLLAP

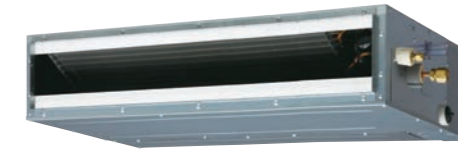

ARXG18KLLAP



For ARXG09/12/14KLLAP For ARXG18KLLAP

### Specifications

Model name	Indoor unit		ARXG09KLLAP	ARXG12KLLAP	ARXG14KLLAP	ARXG18KLLAP
	Outdoor unit		AOEG09KBTB	AOEG12KBTB	AOEG14KBTB	AOEG18KBTB
Power Source	Single phase, ~230 V, 50 Hz					
Capacity	Cooling	Rated	2.5	3.5	4.3	5.2
		Min.-Max.	0.9-3.2	0.9-4.4	0.9-5.4	0.9-5.9
	Heating	Rated	3.2	4.1	5.0	6.0
Min.-Max.		0.9-4.7	0.9-5.7	0.9-6.5	0.9-7.5	
Input Power	Cooling/Heating	kW	0.60/0.79	0.93/1.08	1.28/1.32	1.55/1.62
EER	Cooling	W/W	4.17	3.76	3.36	3.35
COP	Heating	W/W	4.05	3.80	3.79	3.70
Pdesign	Cooling/Heating (-10°C)	kW	2.5/2.6	3.5/3.4	4.3/3.8	5.2/4.4
SEER	Cooling	W/W	6.20	6.10	5.80	6.20
SCOP	Heating	W/W	4.30	4.00	3.90	4.10
Energy Efficiency Class	Cooling		A++	A++	A+	A++
	Heating		A+	A+	A	A+
Max. Operating Current	Cooling/Heating	A	7.9/7.9	9.7/9.7	10.2/10.2	12.1/12.1
Annual Energy Consumption	Cooling	kWh/a	141	201	259	293
	Heating		845	1,189	1,362	1,501
Moisture Removal		l/h	0.7	1.3	1.5	2.0
Sound Pressure Level	Indoor (Cooling)	H/M/L/Q	28/27/26/25	29/28/26/25	32/30/28/26	32/30/29/27
	Indoor (Heating)	H/M/L/Q	28/26/25/24	29/28/26/24	32/30/28/25	32/30/29/27
Sound Power Level	Outdoor (Cooling/Heating)	High	46/46	47/47	49/49	50/50
	Indoor (Cooling/Heating)	High	57/57	58/58	60/60	58/58
Airflow Rate	Indoor/Outdoor (Cooling)	High	600/1,480	650/1,580	800/1,670	940/2,160
	Indoor/Outdoor (Heating)	High	600/1,410	650/1,520	800/1,580	940/1,830
Static pressure range (Standard)		Pa	0 to 90 (25)	0 to 90 (25)	0 to 90 (25)	0 to 90 (25)
Net Dimensions H x W x D	Indoor	mm	198 x 700 x 620	198 x 700 x 620	198 x 700 x 620	198 x 900 x 620
	Outdoor	mm	542 x 799 x 290	542 x 799 x 290	542 x 799 x 290	632 x 799 x 290
Weight	Indoor	kg	17	17	17	20
	Outdoor	kg	32	33	33	36
Connection Pipe Diameter (Liquid/Gas)		mm	6.35/9.52	6.35/9.52	6.35/9.52	6.35/12.70
Drain Hose Diameter (I.D./O.D.)		mm	25/32	25/32	25/32	25/32
Max. Pipe Length (Pre-Charge)		m	20 (15)	25 (15)	25 (15)	30 (20)
Max. Height Difference			15	20	20	20
Operating Range	Cooling	°CDB	-15 to 46	-15 to 46	-15 to 46	-15 to 46
	Heating		-15 to 24	-15 to 24	-15 to 24	-15 to 24
Refrigerant	Type (Global Warming Potential)		R32 (675)	R32 (675)	R32 (675)	R32 (675)
	Charge	kg (CO2eq-T)	0.85 (0.574)	0.85 (0.574)	0.85 (0.574)	1.02 (0.689)

### Optional parts

\* For optional parts compatibility of Intesis devices, please refer to the optional parts compatibility list page C-050 to C-053 and C-066.

Wired Remote Controller (Design type):	UTY-RVRY	WLAN adapter:	UTY-TFSXZ1	Network Converter for single split (DC power supply type):	UTY-VTGX
Compact wired remote controller:	UTY-RCRYZ1		FG-RC-WIF122	Network Converter for single split (AC power supply type):	UTY-VTGXV
Wired remote controller (touch panel):	UTY-RNRYZ5		UTY-TFSXJ3	External connect kit:	UTY-XWZXZG
Wired remote controller:	UTY-RLRY	Silver Ion Filter:	FG-AC-WIF121	Remote sensor unit:	UTY-XSZXZ1
	UTY-RNNYM		UTD-HFTA (09-14)	Auto Louver Grille Kit:	UTD-GXTA-W (09-14)
	UTY-RVNYM		UTD-HFTB (18)		UTD-GXTB-W (18)
Simple remote controller (without operation mode):	UTY-RHRY	External switch controller:	UTY-TERX		
Simple remote controller:	UTY-RSRY	IR receiver unit:	UTY-LBTYM		

### Dimensions

(Unit: mm)

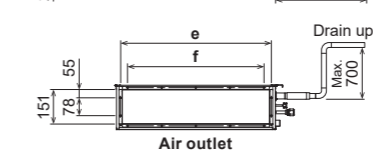
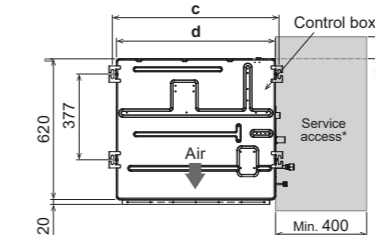
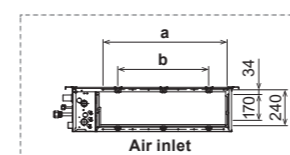

	ARXG 09 / 12 / 14KLLAP	ARXG18KLLAP
a	574	774
b	P200×2=400	P200×3=600
c	734	934
d	700	900
e	650	850
f	P100×6=600	P100×8=800

\*The design of the service access depends on the installation method. Refer to the installation manual for more information.

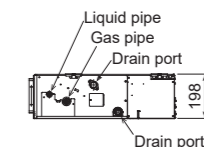

# Medium Static Pressure Duct

High-Efficiency & Comfort



## Slim & Compact design

The new product has reduced the height to 240 mm, making it more compact. The slim design fits nicely into narrow spaces under the ceiling.

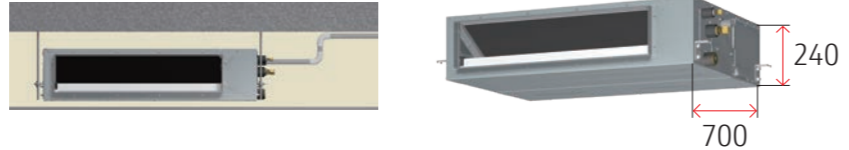

## High energy saving

The new model has achieved high energy efficiency rank with a compact design.

Rank Cooling A++ Heating A+

SEER 6.50\*1 SCOP 4.20\*2

\*1: 12/22 models \*2: 12/22/24 models

## Easy maintenance

The indoor units have large panels on both sides providing easy maintenance in narrow spaces.

- Easy inspection of drain hose:** The whole drain hose can be removed for easy replacement and cleaning.
- Easy cleaning of the heat exchanger:** Large panels on both sides for easy access.
- Filter change:** Filter can be installed and removed easily. \*Long life filter is available as optional parts.

## Drain hose as standard

A drain hose is a standard accessory, making it easy to design drainage even in narrow spaces under the ceiling.



## Wide range of static pressures

Static pressures can be changed in the range of 30 to 150 Pa.

Static pressure range **30 to 150 Pa**

Model: ARXH12KMTAP / ARXH14KMTAP / ARXH18KMTAP / ARXH22KMTAP / ARXH24KMTAP

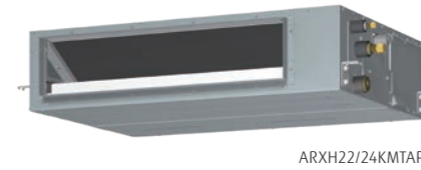

## Specifications

Model name	Indoor unit		ARXH12KMTAP	ARXH14KMTAP	ARXH18KMTAP	ARXH22KMTAP	ARXH24KMTAP
	Outdoor unit		AOEG12KBTB	AOEG14KBTB	AOEG18KBTB	AOEG22KBTB	AOEG24KBTB
Power Source	Single phase, ~230 V, 50 Hz						
Capacity	Cooling	Rated	3.5	4.3	5.2	6.0	6.8
		Min.-Max.	0.9-4.4	0.9-5.4	0.9-5.9	0.9-6.7	0.9-8.0
	Heating	Rated	4.1	5.0	6.0	7.0	7.5
Min.-Max.		0.9-5.7	0.9-6.5	0.9-7.5	0.9-8.0	0.9-9.1	
Input Power	Cooling/Heating	kW	0.930 / 1.080	1.260 / 1.320	1.580 / 1.740	1.67 / 1.84	1.89 / 1.87
EER	Cooling	W/W	3.76	3.40	3.30	3.60	3.60
COP	Heating	W/W	3.80	3.79	3.45	3.80	4.01
Pdesign	Cooling/Heating (-10°C)	kW	3.5 / 3.4	4.3 / 3.8	5.2 / 4.4	6.0 / 4.8	6.8 / 6.0
SEER	Cooling	W/W	6.50	6.10	6.20	6.50	6.40
SCOP	Heating (Average)	W/W	4.20	4.00	4.10	4.20	4.20
Energy Efficiency Class	Cooling		A++	A++	A++	A++	A++
	Heating (Average)		A+	A+	A+	A+	A+
Max. Operating Current	Cooling/Heating	A	9.7 / 9.7	10.2 / 10.2	12.1 / 12.1	12.6 / 12.6	13.6 / 13.6
Annual Energy Consumption	Cooling	kWh/a	196	255	301	331	380
	Heating	kWh/a	1,133	1,330	1,501	1,598	1,999
Moisture Removal		l/h	1.3	1.3	2.0	1.5	2.2
Sound Pressure Level	Indoor (Cooling)	H/M/L/Q	29 / 27 / 25 / 23	32 / 29 / 27 / 25	33 / 30 / 28 / 26	32 / 28 / 25 / 24	34 / 30 / 28 / 26
	Indoor (Heating)	H/M/L/Q	29 / 27 / 25 / 23	32 / 29 / 27 / 25	33 / 30 / 28 / 26	32 / 28 / 25 / 24	34 / 30 / 28 / 26
Sound Power Level	Outdoor (Cooling/Heating)	High	47 / 47	49 / 49	50 / 50	51 / 51	53 / 54
	Indoor (Cooling/Heating)	High	58 / 58	59 / 59	60 / 60	58 / 58	60 / 60
Airflow Rate	Indoor (Cooling/Heating)	High	61 / 61	62 / 62	62 / 62	63 / 63	65 / 66
	Indoor/Outdoor (Cooling)	High	650 / 1,580	800 / 1,670	840 / 2,160	1,150 / 2,240	1,230 / 2,700
Static pressure range (Standard)	Indoor/Outdoor (Heating)	High	650 / 1,520	800 / 1,580	840 / 1,830	1,150 / 1,960	1,230 / 2,700
		Pa	30 to 150 (40)	30 to 150 (40)	30 to 150 (40)	30 to 150 (40)	30 to 150 (50)
Net Dimensions H x W x D	Indoor	mm	240 x 700 x 700	240 x 700 x 700	240 x 700 x 700	240 x 1,000 x 700	240 x 1,000 x 700
	Outdoor	mm	542 x 799 x 290	542 x 799 x 290	632 x 799 x 290	632 x 799 x 290	716 x 820 x 315
Weight	Indoor	kg	24	24	24	31	31
	Outdoor	kg	33	33	36	38	42
Connection Pipe Diameter (Liquid/Gas)		mm	6.35 / 9.52	6.35 / 9.52	6.35 / 12.7	6.35 / 12.70	6.35 / 12.70
Drain Hose Diameter (I.D./O.D.)		mm	25 / 32	25 / 32	25 / 32	25 / 32	25 / 32
Max. Pipe Length (Pre-Charge)		m	25 (15)	25 (15)	30 (20)	30 (20)	30 (20)
Max. Height Difference		m	20	20	20	25	25
Operating Range	Cooling	°CDB	-15 to 46	-15 to 46	-15 to 46	-15 to 46	-15 to 46
	Heating	°CDB	-15 to 24	-15 to 24	-15 to 24	-15 to 24	-15 to 24
Refrigerant	Type (Global Warming Potential)		R32 (675)	R32 (675)	R32 (675)	R32 (675)	R32 (675)
	Charge	kg (CO2eq-T)	0.85 (0.574)	0.85 (0.574)	1.02 (0.689)	1.25 (0.844)	1.25 (0.844)

## Optional parts

\* For optional parts compatibility of Intesis devices, please refer to the optional parts compatibility list page C-050 to C-053 and C-066.

Wired Remote Controller (Design type):	UTY-RVRY	Silver ion filter:	UTD-HFNC (12/14/18)	External input and output PCB:	UTY-XCSX
Compact wired remote controller:	UTY-RCRYZ1		UTD-HFNB (22/24)	External input and output PCB bracket:	UTZ-GXDA
Wired remote controller (touch panel):	UTY-RNRYZ5	Long-life filter:	UTD-LFDC (12/14/18)	Network Converter for single split (DC power supply type):	UTY-VTGX
Wired remote controller:	UTY-RLRY		UTD-LFDB (22/24)	Network Converter for single split (AC power supply type):	UTY-VTGXV
Simple remote controller (without operation mode):	UTY-RHRY	MODBUS converter:	UTY-VMSX	External connect kit:	UTY-XWZXZG
Simple remote controller:	UTY-RSRY	KNX converter:	UTY-VKSX	IR receiver unit:	UTY-LBTYM
Remote sensor unit:	UTY-XSZX	WLAN adapter:	UTY-TFSXZ1	External switch controller:	UTY-TERX
	UTY-XSZXZ1		UTY-TFSXZ3		

## Dimensions

(Unit: mm)

	ARXH 12 / 14 / 18 KMTAP	ARXH 22 / 24 KMTAP
a	650	895
b	740	1,040
c	P100 x 5 = 500	P100 x 8 = 800
d	P100 x 5 = 500	P100 x 7 = 700
e	700	1,000
f	490	790

\*The design of the service access depends on the installation method. Refer to the installation manual for more information.



# Medium Static Pressure Duct

High-Efficiency & Comfort



## Slim & Compact design

The new product has reduced the height to 240 mm, making it more compact. The slim design fits nicely into narrow spaces under the ceiling.



(Unit: mm)

## High energy saving

The new model has achieved high energy efficiency rank with a compact design.

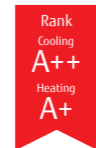

SEER **6.23**<sup>\*1</sup>

SCOP **4.10**<sup>\*2</sup>

\*1: 30 model

\*2: 36 model

## Easy maintenance

The indoor units have large panels on both sides providing easy maintenance in narrow spaces.



**Easy inspection of drain hose**  
The whole drain hose can be removed for easy replacement and cleaning.

**Filter change**  
Filter can be installed and removed easily.  
\*Long life filter is available as optional parts.

## Drain hose as standard

A drain hose is a standard accessory, making it easy to design drainage even in narrow spaces under the ceiling.



## Wide range of static pressures

Static pressures can be changed in the range of 30 to 150 Pa.

Static pressure range **30 to 150 Pa**

Model: ARXH30KMTAP / ARXH36KMTAP / ARXH45KMTAP / ARXH54KMTAP  
ARXH36KMTAP [3-phase] / ARXH45KMTAP [3-phase] / ARXH54KMTAP [3-phase]

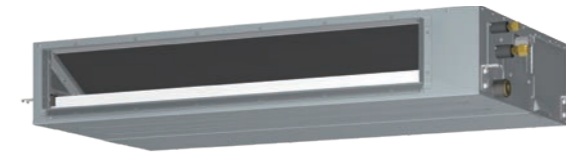

ARXH30/36/45/54KMTAP



For ARXH30/36KMTAP For ARXH45/54KMTAP

## Specifications

Model name	Indoor unit			ARXH30KMTAP	ARXH36KMTAP	ARXH45KMTAP	ARXH36KMTAP	ARXH45KMTAP	ARXH54KMTAP
	Outdoor unit			AOEG30KBTB	AOEG36KBTB	AOEG45KBTB	AOEG36KRTA	AOEG45KRTA	AOEG54KRTA
Power Source	Single phase, ~230 V, 50 Hz						3-phase, ~400 V, 50 Hz		
Capacity	Cooling	Rated	kW	8.5	9.5	12.1	9.5	12.1	13.4
		Min.-Max.		2.8-10.0	2.8-11.2	4.0-13.5	2.8-11.2	4.0-13.5	4.5-14.5
	Heating	Rated	10.0	10.8	13.5	10.8	13.5	15.5	
Input Power	Cooling/Heating	Min.-Max.	kW	2.7-11.2	2.7-12.7	4.2-16.2	2.7-12.7	4.2-16.2	4.7-16.5
		Rated	kW	2.57 / 2.50	2.97 / 2.70	3.87 / 3.73	2.97 / 2.70	3.87 / 3.73	4.62 / 4.65
EER	Cooling	W/W	3.31	3.20	3.13	3.20	3.13	2.90	
COP	Heating	W/W	4.00	4.00	3.62	4.00	3.62	3.33	
Pdesign	Cooling/Heating (-10°C)	kW	8.5 / 8.0	9.5 / 8.7	-	9.5 / 8.7	-	-	
SEER	Cooling	W/W	6.23	6.10	-	6.10	-	-	
SCOP	Heating (Average)	W/W	4.00	4.10	-	4.10	-	-	
Energy Efficiency Class	Cooling		A++	A++	-	A++	-	-	
	Heating (Average)		A+	A+	-	A+	-	-	
Max. Operating Current	Cooling/Heating	A	22.6 / 22.6	22.6 / 22.6	28.5 / 28.5	10.5 / 10.5	14.0 / 14.0	14.0 / 14.0	
Annual Energy Consumption	Cooling	kWh/a	485	553	-	553	-	-	
	Heating	kWh/a	2,795	2,970	-	2,970	-	-	
Moisture Removal		l/h	1.8	2.0	4.0	2.0	4.0	5.0	
Sound Pressure Level	Indoor (Cooling)	H/M/L/Q	38 / 34 / 31 / 28	38 / 34 / 31 / 28	40 / 36 / 32 / 29	38 / 34 / 31 / 28	40 / 36 / 32 / 29	40 / 36 / 32 / 29	
	Indoor (Heating)	H/M/L/Q	38 / 34 / 31 / 28	38 / 34 / 31 / 28	40 / 36 / 32 / 29	38 / 34 / 31 / 28	40 / 36 / 32 / 29	40 / 36 / 32 / 29	
Sound Power Level	Outdoor (Cooling/Heating)	High	53 / 55	55 / 55	57 / 57	55 / 55	57 / 57	57 / 59	
	Indoor (Cooling/Heating)	High	64 / 64	65 / 65	67 / 67	65 / 65	67 / 67	67 / 67	
Airflow Rate	Outdoor (Cooling/Heating)	High	68 / 69	70 / 70	71 / 71	70 / 70	71 / 71	73 / 73	
	Indoor/Outdoor (Cooling)	High	1,950 / 3,750	2,070 / 3,750	2,160 / 4,450	2,070 / 3,750	2,160 / 4,450	2,160 / 4,450	
Static pressure range (Standard)	Indoor/Outdoor (Heating)	High	1,950 / 3,750	2,070 / 3,750	2,160 / 4,450	2,070 / 3,750	2,160 / 4,450	2,160 / 4,450	
	Standard	Pa	30 to 150 (50)	30 to 150 (50)	30 to 150 (60)	30 to 150 (50)	30 to 150 (60)	30 to 150 (60)	
Net Dimensions H x W x D	Indoor	mm	240 × 1,400 × 700	240 × 1,400 × 700	240 × 1,400 × 700	240 × 1,400 × 700	240 × 1,400 × 700	240 × 1,400 × 700	
	Outdoor	mm	788 × 940 × 320	788 × 940 × 320	998 × 940 × 320	788 × 940 × 320	998 × 940 × 320	998 × 940 × 320	
Weight	Indoor	kg	42	42	42	42	42	42	
	Outdoor	kg	52	52	67	53	67	67	
Connection Pipe Diameter (Liquid/Gas)		mm	9.52 / 15.88	9.52 / 15.88	9.52 / 15.88	9.52 / 15.88	9.52 / 15.88	9.52 / 15.88	
Drain Hose Diameter (I.D./O.D.)		mm	25 / 32	25 / 32	25 / 32	25 / 32	25 / 32	25 / 32	
Max. Pipe Length (Pre-Charge)		m	50 (30)	50 (30)	50 (30)	50 (30)	50 (30)	50 (30)	
Max. Height Difference		m	30	30	30	30	30	30	
Operating Range	Cooling	°CDB	-15 to 46	-15 to 46	-15 to 46	-15 to 46	-15 to 46	-15 to 46	
	Heating	°CDB	-15 to 24	-15 to 24	-15 to 24	-15 to 24	-15 to 24	-15 to 24	
Refrigerant	Type (Global Warming Potential)		R32 (675)	R32 (675)	R32 (675)	R32 (675)	R32 (675)	R32 (675)	
	Charge	kg (CO2eq-T)	1.90 (1.283)	1.90 (1.283)	2.70 (1.823)	1.90 (1.283)	2.70 (1.823)	2.70 (1.823)	

## Optional parts

\* For optional parts compatibility of Intesis devices, please refer to the optional parts compatibility list page C-050 to C-053 and C-066.

Wired Remote Controller (Design type):	UTY-RVRY	IR receiver unit:	UTY-LBTYM	External input and output PCB:	UTY-XCSX
Compact wired remote controller:	UTY-RCRYZ1	Silver ion filter:	UTY-HFNA	External input and output PCB bracket:	UTZ-GXDA
Wired remote controller (touch panel):	UTY-RNRZY5	Long-life filter:	UTD-LFDA	Network Converter for single split (DC power supply type):	UTY-VTGX
Wired remote controller:	UTY-RLRY	MODBUS converter:	UTY-VMSX	Network Converter for single split (AC power supply type):	UTY-VTGXV
Simple remote controller (without operation mode):	UTY-RHRY	KNX converter:	UTY-VKX	External connect kit:	UTY-XWZXZG
Simple remote controller:	UTY-RSRY	WLAN adapter:	UTY-TFSXZ1		
Remote sensor unit:	UTY-XSZX		UTY-TFSXJ3	(Outdoor unit)	
	UTY-XSZXZ1	External switch controller:	UTY-TERX	External connect kit:	UTY-XWZXZ3

## Dimensions

(Unit: mm)

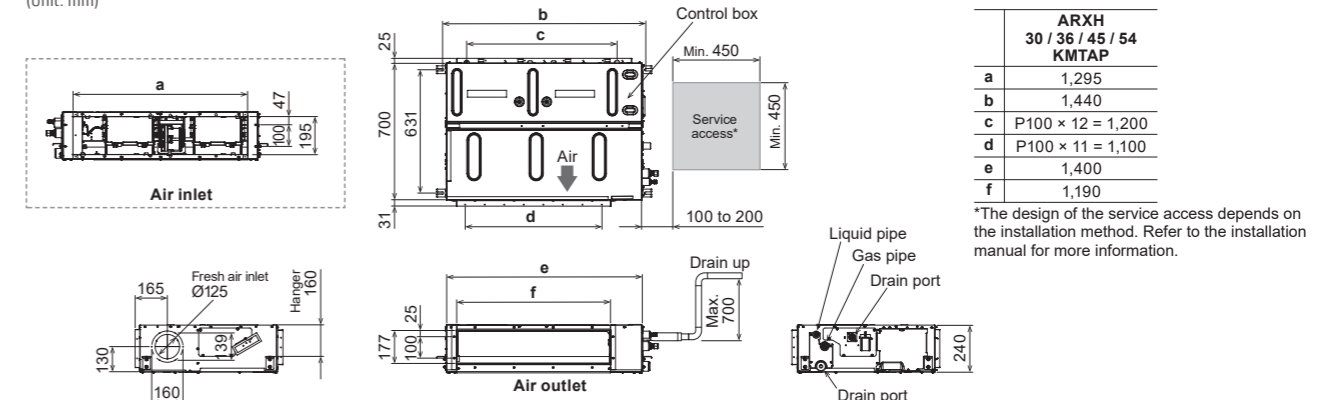

# Medium Static Pressure Duct

Compact Size



## High-efficiency & Quiet operation

The combination of the V-shaped heat exchanger, air stabilizer, and the high-efficiency DC fan motor enable high-efficiency and quiet operation.

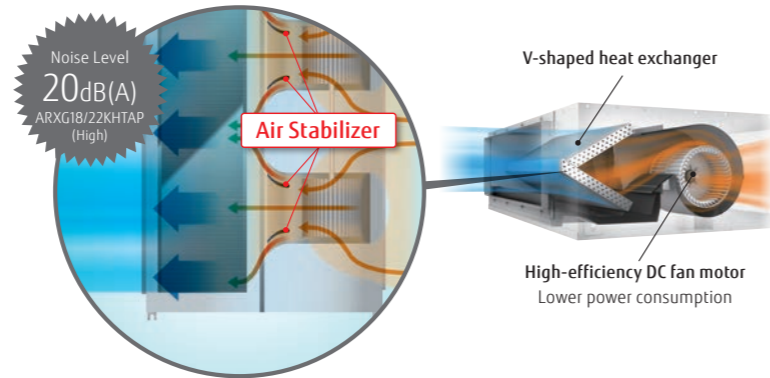

## Small, lightweight outdoor unit

The outdoor unit in this series is smaller and lighter than previous-generation outdoor units. It can be installed in a narrow space.



## Automatic airflow adjustment function

This unique and innovative function detects required air flow in each application case and automatically adjust the volume.

Automatically adjust!

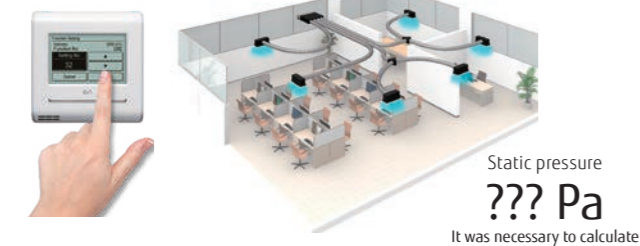

## Link up with a variety of central control system (Option)

Centralized control including facilities and equipment in addition to air conditioning is possible by linking up with MODBUS, KNX interfaces.



Model: ARXG12KHTAP / ARXG14KHTAP / ARXG18KHTAP / ARXG22KHTAP / ARXG24KHTAP / ARXG30KHTAP

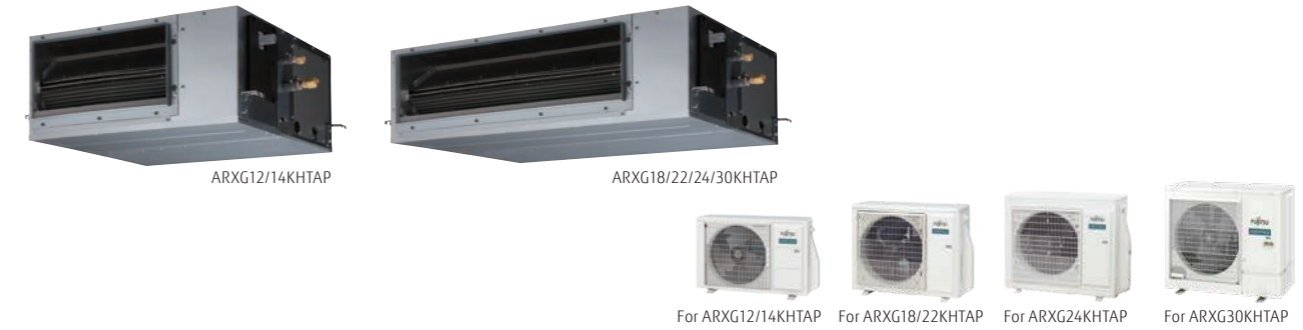

### Specifications

Model name	Indoor unit		ARXG12KHTAP	ARXG14KHTAP	ARXG18KHTAP	ARXG22KHTAP	ARXG24KHTAP	ARXG30KHTAP
	Outdoor unit		AOEG12KBTB	AOEG14KBTB	AOEG18KBTB	AOEG22KBTB	AOEG24KBTB	AOEG30KBTB
Power Source	Single phase, ~230 V, 50 Hz							
Capacity	Cooling	Rated	3.5	4.3	5.2	6.0	6.8	8.5
		Min.-Max.	0.9-4.4	0.9-5.4	0.9-5.9	0.9-6.7	0.9-8.0	2.8-10.0
	Heating	Rated	4.1	5.0	6.0	7.0	7.5	10.0
Min.-Max.		0.9-5.7	0.9-6.5	0.9-7.5	0.9-8.0	0.9-9.1	2.7-11.2	
Input Power	Cooling/Heating	kW	0.87/1.00	1.17/1.25	1.36/1.56	1.71/1.81	1.89/1.85	2.65/2.63
EER	Cooling	W/W	4.02	3.68	3.82	3.51	3.60	3.21
COP	Heating	W/W	4.10	4.00	3.85	3.87	4.06	3.80
Pdesign	Cooling/Heating (-10°C)	kW	3.5/3.4	4.3/3.8	5.2/4.4	6.0/4.8	6.8/6.0	8.5/8.0
SEER	Cooling	W/W	6.30	6.20	6.50	6.50	6.50	6.23
SCOP	Heating (Average)	W/W	4.10	4.00	4.10	4.20	4.10	4.00
Energy Efficiency Class	Cooling		A++	A++	A++	A++	A++	A++
	Heating (Average)		A+	A+	A+	A+	A+	A+
Max. Operating Current	Cooling/Heating	A	9.7/9.7	10.2/10.2	12.1/12.1	12.6/12.6	13.6/13.6	22.6/22.6
Annual Energy Consumption	Cooling	kWh/a	194	243	280	323	366	477
	Heating	kWh/a	1,159	1,328	1,501	1,597	2,048	2,796
Moisture Removal		l/h	0.7	0.9	1.2	1.5	1.8	2.3
Sound Pressure Level	Indoor (Cooling)	H/M/L/Q	32/27/26/24	33/28/27/25	28/25/22/20	28/25/22/20	32/28/24/21	36/33/30/29
	Indoor (Heating)	H/M/L/Q	32/27/26/24	33/28/27/25	28/25/22/20	28/25/22/20	32/28/24/21	36/33/30/29
Sound Power Level	Outdoor (Cooling/Heating)	High	47/47	49/49	50/50	51/51	53/54	53/55
	Indoor (Cooling/Heating)	High	57/58	59/60	54/54	57/57	57/57	63/65
Airflow Rate	Indoor/Outdoor (Cooling)	High	850/1,580	950/1,670	1,050/2,160	1,050/2,240	1,360/2,700	1,700/3,750
	Indoor/Outdoor (Heating)	High	850/1,520	950/1,580	1,050/1,830	1,050/1,960	1,360/2,700	1,700/3,750
Static pressure range (Standard)		Pa	30 to 200 (35)	30 to 200 (35)	30 to 200 (35)	30 to 200 (35)	30 to 200 (35)	30 to 200 (47)
Net Dimensions H x W x D	Indoor	mm	300 x 700 x 700	300 x 700 x 700	300 x 1,000 x 700	300 x 1,000 x 700	300 x 1,000 x 700	300 x 1,000 x 700
	Outdoor	mm	542 x 799 x 290	542 x 799 x 290	632 x 799 x 290	632 x 799 x 290	716 x 820 x 315	788 x 940 x 320
Weight	Indoor	kg	27	27	35	35	36	36
	Outdoor	kg	33	33	36	38	42	52
Connection Pipe Diameter (Liquid/Gas)		mm	6.35/9.52	6.35/9.52	6.35/12.70	6.35/12.70	6.35/12.70	9.52/15.88
Drain Hose Diameter (I.D./O.D.)		mm	25/32	25/32	25/32	25/32	25/32	25/32
Max. Pipe Length (Pre-Charge)		m	25 (15)	25 (15)	30 (20)	30 (20)	30 (20)	50 (30)
Max. Height Difference	Cooling	°CDB	-15 to 46	-15 to 46	-15 to 46	-15 to 46	-15 to 46	-15 to 46
	Heating	°CDB	-15 to 24	-15 to 24	-15 to 24	-15 to 24	-15 to 24	-15 to 24
Operating Range	Cooling	°CDB	-15 to 46	-15 to 46	-15 to 46	-15 to 46	-15 to 46	-15 to 46
	Heating	°CDB	-15 to 24	-15 to 24	-15 to 24	-15 to 24	-15 to 24	-15 to 24
Refrigerant	Type (Global Warming Potential)		R32 (675)	R32 (675)	R32 (675)	R32 (675)	R32 (675)	R32 (675)
	Charge	kg (CO <sub>2</sub> eq-t)	0.85 (0.574)	0.85 (0.574)	1.02 (0.689)	1.25 (0.844)	1.25 (0.844)	1.90 (1.283)

### Optional parts

\* For optional parts compatibility of Intesis devices, please refer to the optional parts compatibility list page C-050 to C-053 and C-066.

Wired Remote Controller (Design type):	UTY-RVRY	Long-life filter:	UTD-LFNB (18-30)	External input and output PCB:	UTY-XCSX
Compact wired remote controller:	UTY-RCRYZ1		UTD-LFNC (12-14)	External connect kit:	UTY-XWZXZG
Wired remote controller (touch panel):	UTY-RNRYZ5	Silver Ion Filter:	UTD-HFNB (18-30)	External input and output PCB bracket:	UTZ-GXNA
Wired remote controller:	UTY-RLRY		UTD-HFNC (12/14)	Network Converter for single split (DC power supply type):	UTY-VTGV
	UTY-RNNYM	WLAN adapter:	UTY-TFSXZ1	Network Converter for single split (AC power supply type):	UTY-VTGXV
	UTY-RVNYM		FG-RC-WIF122	External switch controller:	UTY-TERX
Simple remote controller (without operation mode):	UTY-RHRY		UTY-TFSXJ3		
Simple remote controller:	UTY-RSRY		FG-AC-WIF121		
Remote sensor unit:	UTY-XS2XZ1	IR receiver unit:	UTY-LBTYM	(Outdoor unit 30)	
				External connect kit:	UTY-XWZXZ3

### Dimensions

(Unit: mm)

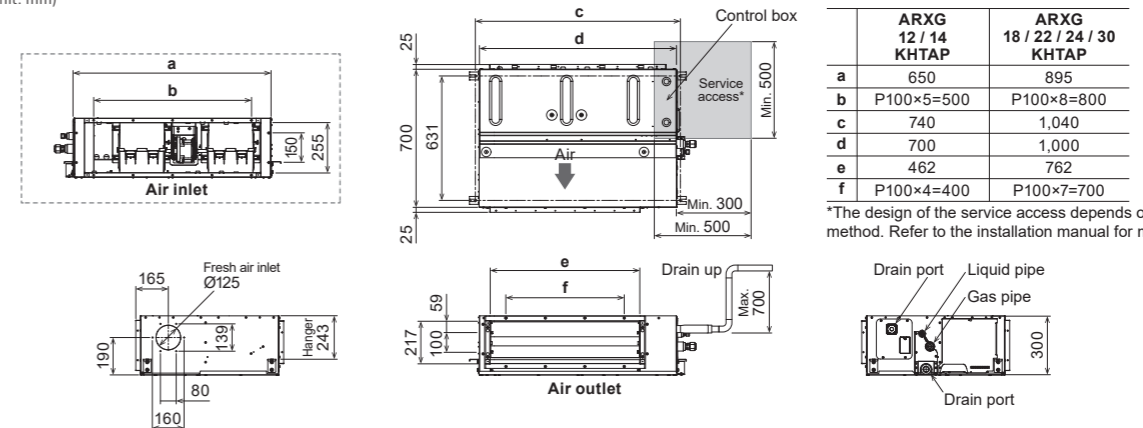

	ARXG 12 / 14 KHTAP	ARXG 18 / 22 / 24 / 30 KHTAP
a	650	895
b	P100×5=500	P100×8=800
c	740	1,040
d	700	1,000
e	462	762
f	P100×4=400	P100×7=700

\*The design of the service access depends on the installation method. Refer to the installation manual for more information.



# Medium Static Pressure Duct

Compact Size

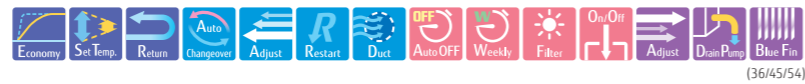

Model: ARXG36KHTAP / ARXG45KHTAP / ARXG54KHTAP  
 ARXG36KHTAP [3-phase] / ARXG45KHTAP [3-phase] / ARXG54KHTAP [3-phase]



### Specifications

Model name	Indoor unit			Outdoor unit				
	ARXG36KHTAP	ARXG45KHTAP	ARXG54KHTAP	AOEG36KBTB	AOEG45KBTB	AOEG54KBTB		
Power Source	Single phase, ~230 V, 50 Hz			3-phase, ~400 V, 50 Hz				
Capacity	Cooling	Rated	9.5	12.1	13.4	9.5	12.1	13.4
		Min.-Max.	2.8-11.2	4.0-14.0	4.5-14.5	2.8-11.2	4.0-14.0	4.5-14.5
	Heating	Rated	10.8	13.5	15.5	10.8	13.5	15.5
Input Power	Cooling/Heating	Rated	2.7-12.7	4.2-16.2	4.7-16.5	2.7-12.7	4.2-16.2	4.7-16.5
		Min.-Max.	2.86/2.48	3.53/3.37	4.42/3.89	2.86/2.48	3.53/3.37	4.42/3.89
EER	Cooling	W/W	3.32	3.43	3.03	3.32	3.43	3.03
COP	Heating	W/W	4.35	4.01	3.98	4.35	4.01	3.98
Pdesign	Cooling/Heating (-10°C)	kW	9.5/8.7	-	-	9.5/8.7	-	-
SEER	Cooling	W/W	6.10	-	-	6.10	-	-
SCOP	Heating (Average)	W/W	4.20	-	-	4.20	-	-
Energy Efficiency Class	Cooling		A++	-	-	A++	-	-
	Heating (Average)		A+	-	-	A+	-	-
Max. Operating Current	Cooling/Heating	A	22.6/22.6	28.5/28.5	28.5/28.5	10.5/10.5	14.0/14.0	14.0/14.0
Annual Energy Consumption	Cooling	kWh/a	544	-	-	544	-	-
	Heating	kWh/a	2,898	-	-	2,898	-	-
Moisture Removal		l/h	2.0	2.6	3.7	2.0	2.6	3.7
Sound Pressure Level	Indoor (Cooling)	H/M/L/Q	36/31/28/26	39/35/31/29	39/35/31/29	36/31/28/26	39/35/31/29	39/35/31/29
	Indoor (Heating)	H/M/L/Q	33/31/28/26	39/35/31/29	39/35/31/29	33/31/28/26	39/35/31/29	39/35/31/29
Sound Power Level	Outdoor (Cooling/Heating)	High	55/55	57/57	57/59	55/55	57/57	57/59
	Indoor (Cooling/Heating)	High	64/63	67/69	67/69	64/63	67/69	67/69
Airflow Rate	Indoor/Outdoor (Cooling)	High	2,050/3,750	2,550/4,450	2,550/4,450	2,050/3,750	2,550/4,450	2,550/4,450
	Indoor/Outdoor (Heating)	High	1,850/3,750	2,550/4,450	2,550/4,450	1,850/3,750	2,550/4,450	2,550/4,450
Static pressure range (Standard)		Pa	30 to 200 (47)	30 to 200 (60)	30 to 200 (60)	30 to 200 (47)	30 to 200 (60)	30 to 200 (60)
Net Dimensions H x W x D	Indoor	mm	300 x 1,400 x 700	300 x 1,400 x 700	300 x 1,400 x 700	300 x 1,400 x 700	300 x 1,400 x 700	300 x 1,400 x 700
	Outdoor	mm	788 x 940 x 320	998 x 940 x 320	998 x 940 x 320	788 x 940 x 320	998 x 940 x 320	998 x 940 x 320
Weight	Indoor	kg	46	46	46	46	46	46
	Outdoor	kg	52	67	67	53	67	67
Connection Pipe Diameter (Liquid/Gas)		mm	9.52/15.88	9.52/15.88	9.52/15.88	9.52/15.88	9.52/15.88	9.52/15.88
Drain Hose Diameter (I.D./O.D.)		mm	25/32	25/32	25/32	25/32	25/32	25/32
Max. Pipe Length (Pre-Charge)		m	50 (30)	50 (30)	50 (30)	50 (30)	50 (30)	50 (30)
Max. Height Difference			30	30	30	30	30	30
Operating Range	Cooling	°CDB	-15 to 46	-15 to 46	-15 to 46	-15 to 46	-15 to 46	-15 to 46
	Heating	°CDB	-15 to 24	-15 to 24	-15 to 24	-15 to 24	-15 to 24	-15 to 24
Refrigerant	Type (Global Warming Potential)		R32 (675)	R32 (675)	R32 (675)	R32 (675)	R32 (675)	R32 (675)
	Charge	kg (CO2eq-T)	1.90 (1.283)	2.70 (1.823)	2.70 (1.823)	1.90 (1.283)	2.70 (1.823)	2.70 (1.823)

### High-efficiency & Quiet operation

The combination of the V-shaped heat exchanger, air stabilizer, and the high-efficiency DC fan motor enable high-efficiency and quiet operation.

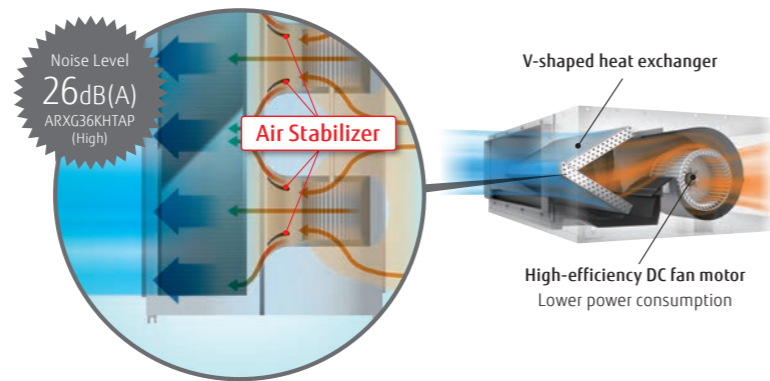

### Small, lightweight outdoor unit

The outdoor unit in this series is smaller and lighter than previous-generation outdoor units. It can be installed in a narrow space.

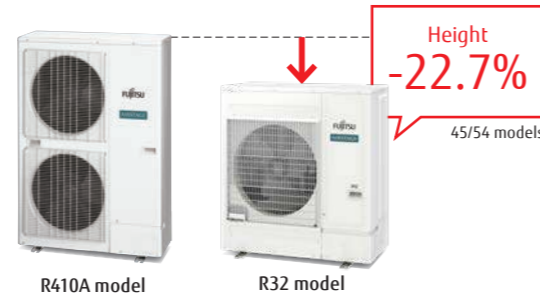

### Automatic airflow adjustment function

This unique and innovative function detects required air flow in each application case and automatically adjust the volume.



### Link up with a variety of central control system (Option)

Centralized control including facilities and equipment in addition to air conditioning is possible by linking up with MODBUS, KNX interfaces.



### Optional parts

\* For optional parts compatibility of Intesis devices, please refer to the optional parts compatibility list page C-050 to C-053 and C-066.

Wired Remote Controller (Design type): UTY-RVRY	Long-life filter: UTD-LFNA	External input and output PCB: UTY-XCSX
Compact wired remote controller: UTY-RCRYZ1	Silver Ion Filter: UTD-HFNA	External input and output PCB bracket: UTZ-GXNA
Wired remote controller (touch panel): UTY-RNRYZ5	WLAN adapter: UTY-TFSXZ1	Network Inverter for single split (DC power supply type): UTY-VTGX
Wired remote controller: UTY-RLRY	WLAN adapter: UTY-TFSXJ3	Network Converter for single split (AC power supply type): UTY-VTGXV
Simple remote controller (without operation mode): UTY-RHRY	External switch controller: UTY-TERX	(Outdoor unit 36/45/54)
Simple remote controller: UTY-RSRY	IR receiver unit: UTY-LBTYM	External connect kit: UTY-XWZXZ3
Remote sensor unit: UTY-XSZXZ1	External connect kit: UTY-XWZXZG	

### Dimensions

(Unit: mm)

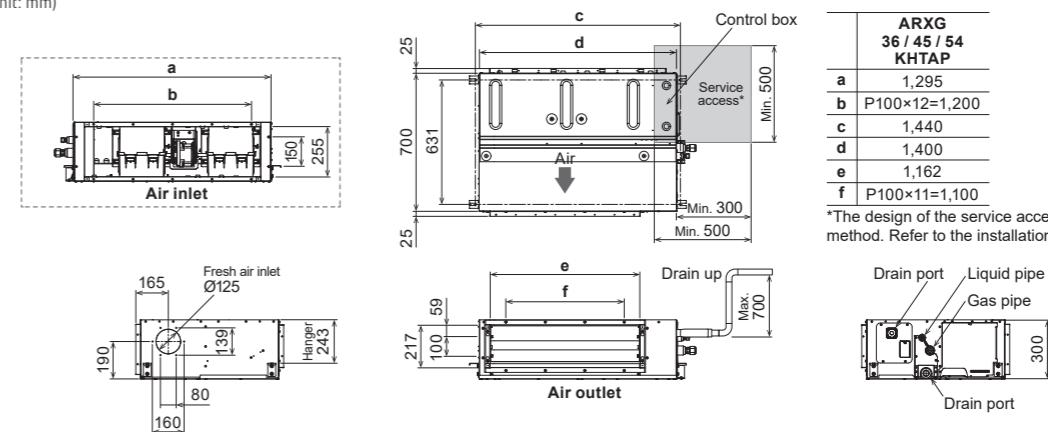

ARXG 36 / 45 / 54 KHTAP	
a	1,295
b	P100×12=1,200
c	1,440
d	1,400
e	1,162
f	P100×11=1,100

\*The design of the service access depends on the installation method. Refer to the installation manual for more information.

# Medium Static Pressure Duct Standard



## Easy maintenance

Structural improvement is attained by making the bottom panel in two pieces—front and rear. The internal fan casing is also manufactured in two pieces—upper and lower. As a result, the motor and fan can be easily accessed and maintained by removing the rear panel and the lower casing while leaving the main chassis in place.

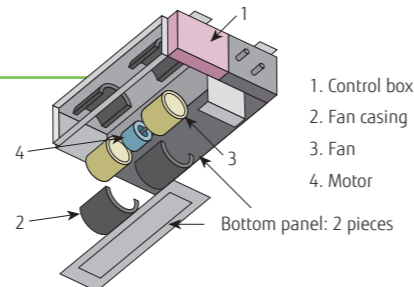

See below for case of rear-suction type

## Slim & Compact design

### Indoor Unit

The slim and compact design of the indoor unit, with the control box mounted on the side, allows installation in narrow spaces.

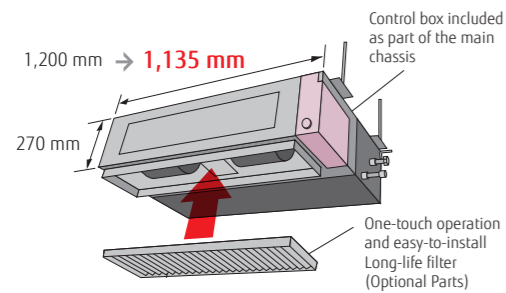

### Outdoor Unit

The outdoor units for the 45,000 BTU and 54,000 BTU models have been completely redesigned. Easier installation is achieved for this compact and lightweight outdoor unit.

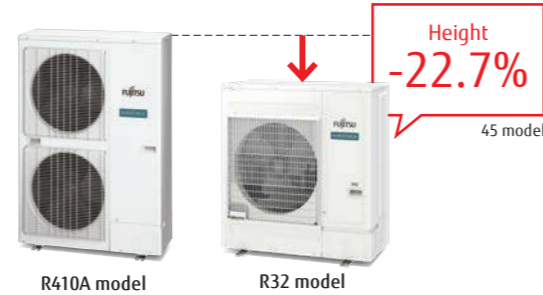

## Two-direction drain piping

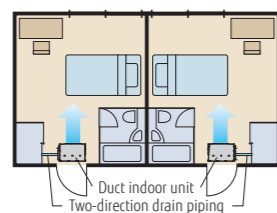

## Link up with a variety of central control system (Option)

Centralized control including facilities and equipment in addition to air conditioning is possible by linking up with MODBUS, KNX interfaces.



Model: ARXG22KMLB / ARXG24KMLA / ARXG30KMLA / ARXG36KMLA / ARXG45KMLA  
ARXG36KMLA [3-phase] / ARXG45KMLA [3-phase]

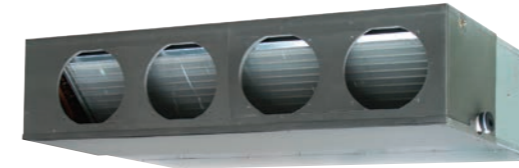

## Specifications

Model name	Indoor unit		ARXG22KMLB	ARXG24KMLA	ARXG30KMLA	ARXG36KMLA	ARXG45KMLA	ARXG36KMLA	ARXG45KMLA
	Outdoor unit		AOEG22KBTB	AOEG24KBTB	AOEG30KBTB	AOEG36KBTB	AOEG45KBTB	AOEG36KRTA	AOEG45KRTA
Power Source	Single phase, ~230 V, 50 Hz							3-phase, ~400 V, 50 Hz	
Capacity	Cooling	Rated	6.0	6.8	8.5	9.5	12.1	9.5	12.1
		Min.-Max.	0.9-6.7	0.9-8.0	2.8-10.0	2.8-11.2	4.0-13.0	2.8-11.2	4.0-13.0
	Heating	Rated	7.0	7.5	10.0	10.8	13.5	10.8	13.5
		Min.-Max.	0.9-8.0	0.9-9.1	2.7-11.2	2.7-12.7	4.2-15.2	2.7-12.7	4.2-15.2
Input Power	Cooling/Heating		1.78/1.87	2.14/1.97	2.65/2.63	2.97/2.88	4.22/3.84	2.97/2.88	4.22/3.84
EER	Cooling		3.37	3.18	3.21	3.20	2.87	3.20	2.87
COP	Heating		3.74	3.80	3.80	3.75	3.52	3.75	3.52
Pdesign	Cooling/Heating (-10°C)		6.0/4.8	6.8/6.0	8.5/8.0	9.5/8.7	-	9.5/8.7	-
SEER	Cooling		6.10	6.20	6.23	6.10	-	6.10	-
SCOP	Heating		4.10	4.10	4.00	4.00	-	4.00	-
Energy Efficiency Class	Cooling		A++	A++	A++	A++	-	A++	-
	Heating		A+	A+	A+	A+	-	A+	-
Max. Operating Current	Cooling/Heating		12.6/12.6	13.6/13.6	22.6/22.6	22.6/22.6	28.5/28.5	10.5/10.5	14.0/14.0
Annual Energy Consumption	Cooling		344	384	477	545	-	545	-
	Heating		1,637	2,045	2,797	3,044	-	3,044	-
Moisture Removal			2.1	2.5	2.5	3.0	4.0	3.0	4.0
Sound Pressure Level	Indoor (Cooling)	H/M/L/Q	31/29/27/25	31/29/27/25	39/35/30/26	39/35/30/26	42/38/32/28	39/35/30/26	42/38/32/28
	Indoor (Heating)	H/M/L/Q	31/29/27/25	31/29/27/25	42/35/30/26	42/35/30/26	42/38/32/28	42/35/30/26	42/38/32/28
Sound Power Level	Outdoor (Cooling/Heating)	High	51/51	53/54	53/55	55/55	57/57	55/55	57/57
	Outdoor (Cooling/Heating)	High	60/62	60/62	65/69	65/70	68/70	65/70	68/70
Airflow Rate	Indoor/Outdoor (Cooling)	High	1,100/2,240	1,100/2,700	1,900/3,750	1,900/3,750	2,100/4,450	1,900/3,750	2,100/4,450
	Indoor/Outdoor (Heating)	High	1,100/1,960	1,100/2,700	2,100/3,750	2,100/3,750	2,100/4,450	2,100/3,750	2,100/4,450
Static pressure range (Standard)		Pa	30 to 150 (35)	30 to 150 (35)	30 to 150 (47)	30 to 150 (47)	30 to 150 (60)	30-150 (47)	30-150 (60)
Net Dimensions H x W x D	Indoor	mm	270 x 1,135 x 700	270 x 1,135 x 700	270 x 1,135 x 700	270 x 1,135 x 700	270 x 1,135 x 700	270 x 1,135 x 700	270 x 1,135 x 700
	Outdoor	mm	632 x 799 x 290	716 x 820 x 315	788 x 940 x 320	788 x 940 x 320	998 x 940 x 320	788 x 940 x 320	998 x 940 x 320
Weight	Indoor	kg	35	35	38	38	39	38	39
	Outdoor	kg	38	42	52	52	67	53	67
Connection Pipe Diameter (Liquid/Gas)		mm	6.35/12.70	6.35/12.70	9.52/15.88	9.52/15.88	9.52/15.88	9.52/15.88	9.52/15.88
Drain Hose Diameter (I.D./O.D.)		mm	35.7/38.1	35.7/38.1	35.7/38.1	35.7/38.1	35.7/38.1	35.7/38.1	35.7/38.1
Max. Pipe Length (Pre-Charge)		m	30 (20)	30 (20)	50 (30)	50 (30)	50 (30)	50 (30)	50 (30)
Max. Height Difference			25	25	30	30	30	30	30
Operating Range	Cooling	°CDB	-15 to 46	-15 to 46	-15 to 46	-15 to 46	-15 to 46	-15 to 46	-15 to 46
	Heating		-15 to 24	-15 to 24	-15 to 24	-15 to 24	-15 to 24	-15 to 24	-15 to 24
Refrigerant	Type (Global Warming Potential)		R32 (675)	R32 (675)	R32 (675)	R32 (675)	R32 (675)	R32 (675)	R32 (675)
	Charge	kg (CO2eq-T)	1.25 (0.844)	1.25 (0.844)	1.90 (1.283)	1.90 (1.283)	2.70 (1.823)	1.90 (1.283)	2.70 (1.823)

## Optional parts

\* For optional parts compatibility of Intesis devices, please refer to the optional parts compatibility list page C-050 to C-053 and C-066.

Wired Remote Controller (Design type):	UTY-RVRY	WLAN adapter:	UTY-TFSXZ1	Network Converter for single split (DC power supply type):	UTY-VTGX
Compact wired remote controller:	UTY-RCRYZ1		FG-RC-WIF1Z2	Network Converter for single split (AC power supply type):	UTY-VTGXV
Wired remote controller (touch panel):	UTY-RNRYZ5		UTY-TFSXJ3	Long-life filter:	UTD-LF25NA
Wired remote controller:	UTY-RLRY		FG-AC-WIF1Z1	Silver Ion Filter:	UTD-HFND
	UTY-RNNYM	Flange (Round):	UTD-RF204	External connect kit:	UTY-XWZXZG
	UTY-RVNYM	Flange (Square):	UTD-SF045T		
Simple remote controller (without operation mode):	UTY-RHRY	IR receiver unit:	UTY-LBTYM	(Outdoor unit 30/36/45)	
Simple remote controller:	UTY-RSRY	Remote sensor unit:	UTY-XSZXZ1	External connect kit:	UTY-XWZXZ3
External switch controller:	UTY-TERX	Drain pump unit:	UTZ-PX1NBA		

## Dimensions

(Unit: mm)

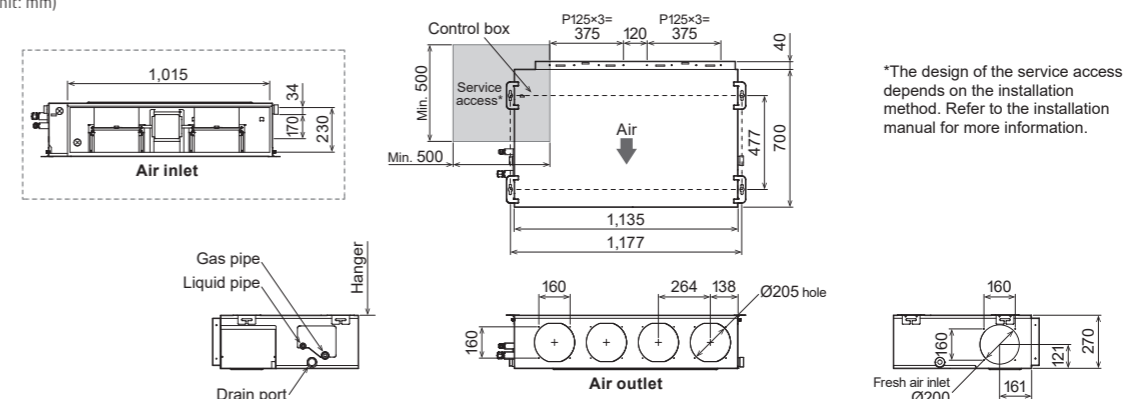

\*The design of the service access depends on the installation method. Refer to the installation manual for more information.



# High Static Pressure Duct



## Easy installation (Compact & Lightweight)

The indoor and outdoor units are designed to be compact and light by reducing the basic chassis size and the overall material weight.

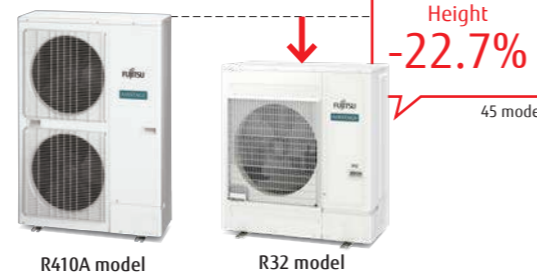
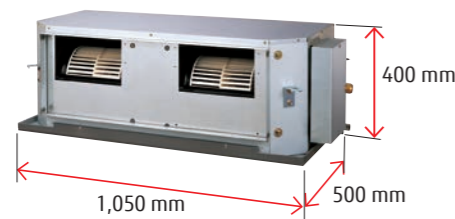

## Design also suits high static pressure

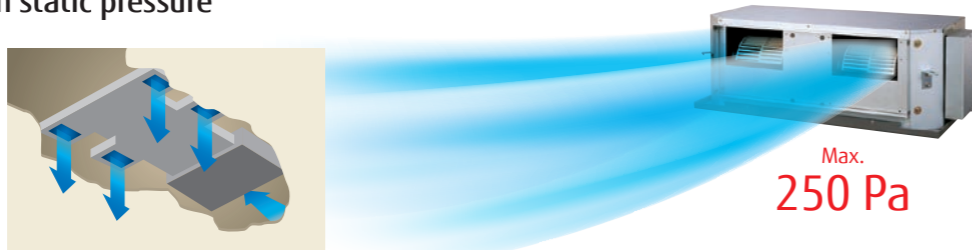

## Low noise

Slanted corners at the top help reduce turbulent airflow. Low noise is realized by adopting a plastic case and a plastic fan.

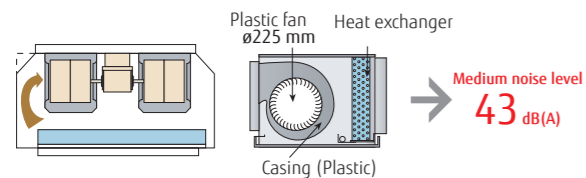

## Link up with a variety of central control system (Option)

Centralized control including facilities and equipment in addition to air conditioning is possible by linking up with MODBUS, KNX interfaces.



Model: ARXG45KHTB / ARXG54KHTB  
ARXG45KHTB [3-phase] / ARXG54KHTB [3-phase]



### Specifications

Model name	Indoor unit		ARXG45KHTB	ARXG54KHTB	ARXG45KHTB	ARXG54KHTB
	Outdoor unit		AOEG45KHTB	AOEG54KHTB	AOEG45KRTA	AOEG54KRTA
Power Source	Single phase, ~230 V, 50 Hz			3-phase, ~400 V, 50 Hz		
Capacity	Cooling	Rated	12.1	13.4	12.1	13.4
		Min.-Max.	4.0-14.0	5.0-14.5	4.0-14.0	5.0-14.5
	Heating	Rated	13.5	15.5	13.5	15.5
		Min.-Max.	5.0-16.2	5.5-18.0	5.0-16.2	5.5-18.0
Input Power	Cooling/Heating	kW	4.16/3.61	4.77/4.18	4.16/3.61	4.77/4.18
EER	Cooling	W/W	2.91	2.81	2.91	2.81
COP	Heating	W/W	3.74	3.71	3.74	3.71
Pdesign	Cooling/Heating (-10°C)	kW	-	-	-	-
SEER	Cooling	W/W	-	-	-	-
SCOP	Heating	W/W	-	-	-	-
Energy Efficiency Class	Cooling	-	-	-	-	-
	Heating	-	-	-	-	-
Max. Operating Current	Cooling/Heating	A	28.5/28.5	28.5/28.5	14.0/14.0	14.0/14.0
Annual Energy Consumption	Cooling	kWh/a	-	-	-	-
	Heating	kWh/a	-	-	-	-
Moisture Removal		l/h	1.5	2.0	1.5	2.0
Sound Pressure Level	Indoor (Cooling)	H/M/L	47/43/40	47/43/40	47/43/40	47/43/40
	Indoor (Heating)	H/M/L	47/43/40	47/43/40	47/43/40	47/43/40
Sound Power Level	Outdoor (Cooling/Heating)	High	57/57	57/59	57/57	57/59
	Indoor (Cooling/Heating)	High	75/74	75/74	75/74	75/74
Airflow Rate	Indoor/Outdoor (Cooling)	High	3,350/4,450	3,350/4,450	3,350/4,450	3,350/4,450
	Indoor/Outdoor (Heating)	High	3,350/4,450	3,350/4,450	3,350/4,450	3,350/4,450
Static pressure range (Standard)		Pa	100 to 250 (100)	100 to 250 (100)	100 to 250 (100)	100 to 250 (100)
Net Dimensions	Indoor	mm	400 × 1,050 × 500	400 × 1,050 × 500	400 × 1,050 × 500	400 × 1,050 × 500
H x W x D	Outdoor	mm	998 × 940 × 320	998 × 940 × 320	998 × 940 × 320	998 × 940 × 320
Weight	Indoor	kg	46	46	46	46
	Outdoor	kg	67	67	67	67
Connection Pipe Diameter (Liquid/Gas)		mm	9.52/15.88	9.52/15.88	9.52/15.88	9.52/15.88
Drain port Diameter (I.D./O.D.)		mm	23.4/25.4	23.4/25.4	23.4/25.4	23.4/25.4
Max. Pipe Length (Pre-Charge)		m	50 (30)	50 (30)	50 (30)	50 (30)
Max. Height Difference			30	30	30	30
Operating Range	Cooling	°CDB	-15 to 46	-15 to 46	-15 to 46	-15 to 46
	Heating	°CDB	-15 to 24	-15 to 24	-15 to 24	-15 to 24
Refrigerant	Type (Global Warming Potential)		R32 (675)	R32 (675)	R32 (675)	R32 (675)
	Charge	kg (CO2eq-T)	2.70 (1.823)	2.70 (1.823)	2.70 (1.823)	2.70 (1.823)

### Optional parts

\* For optional parts compatibility of Intesis devices, please refer to the optional parts compatibility list page C-050 to C-053 and C-066.

Wired Remote Controller (Design type):	UTY-RVRY	Remote sensor unit:	UTY-XSZXZ1	Network Converter for single split (DC power supply type):	UTY-VTGX
Compact wired remote controller:	UTY-RCRYZ1	Long-life filter:	UTD-LF60KA	Network Converter for single split (AC power supply type):	UTY-VTGXV
Wired remote controller (touch panel):	UTY-RNRYZ5	External switch controller:	UTY-TERX	Silver Ion Filter:	UTD-HFKB
Wired remote controller:	UTY-RLRY	WLAN adapter:	UTY-TFSXZ1	External connect kit:	UTY-XWZXZG
Simple remote controller:	UTY-RSRY		UTY-TFSXJ3		
	UTY-RHRY		FG-AC-WIF1Z1	(Outdoor unit)	
IR Receiver unit:	UTY-LBTYM	External input and output PCB:	UTY-XCSX+UTZ-GXEA	External connect kit:	UTY-XWZXZ3

### Dimensions

(Unit: mm)

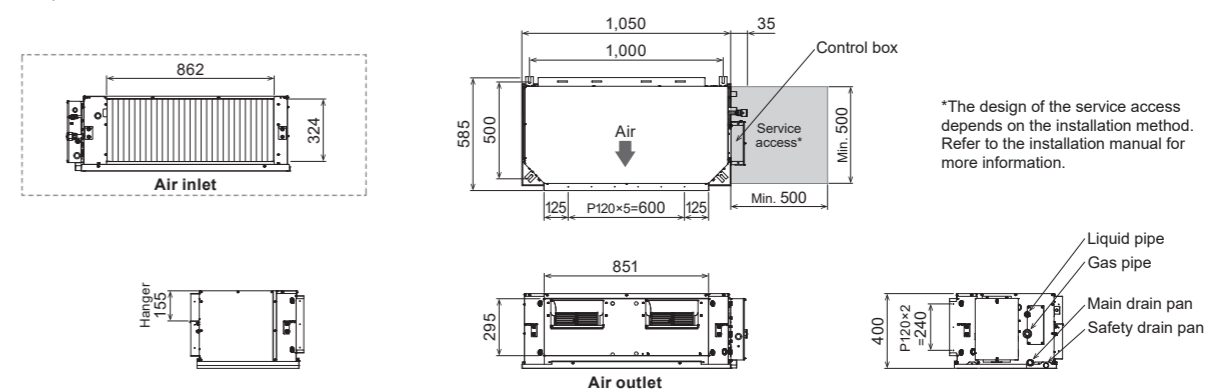

# High Static Pressure Duct



## High energy efficiency

Much greater efficiency is achieved by the use of all-DC inverter technology.

## Design also corresponding to high static pressure

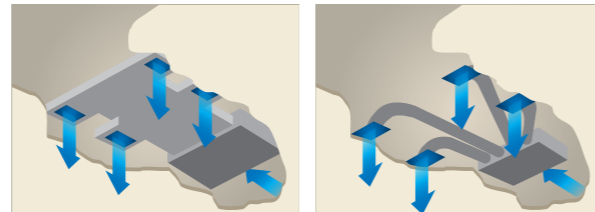
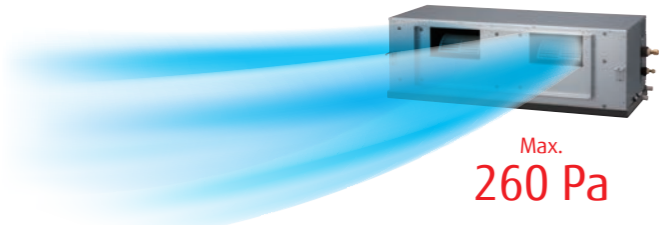

## Easy installation (Compact & Lightweight)

The indoor unit is designed to be compact and light by reducing the basic chassis size and the overall material weight.



## Low noise

Slanted corners at the top help reduce turbulent airflow. Low noise is realized by adopting a plastic case and a plastic fan.

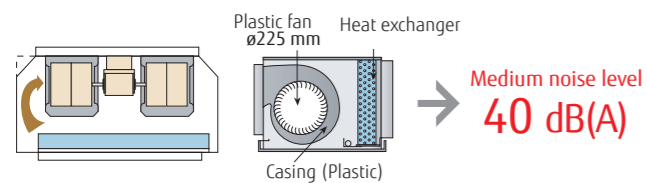

## Link up with a variety of central control system (Option)

Centralized control including facilities and equipment in addition to air conditioning is possible by linking up with MODBUS, KNX interfaces.



## Model: ARYG60LHTA [3-phase]



## Specifications

Model name	Indoor unit		Outdoor unit		ARYG60LHTA	AOYG60LATT
	Indoor unit		Outdoor unit			
Power Source					3-phase, ~400 V, 50 Hz	
Capacity	Cooling	Rated	kW	15.0		
		Min.-Max.		6.2-17.5		
	Heating	Rated	18.0			
Min.-Max.		6.2-20.0				
Input Power	Cooling/Heating		kW	4.70/5.15		
EER	Cooling		W/W	3.19		
COP	Heating		W/W	3.50		
Max. Operating Current	Cooling/Heating		A	12.5 / 12.5		
Moisture Removal			l/h	2.0		
Sound Pressure	Indoor (Cooling)	H/M/L/Q	dB(A)	45/40/36/-		
	Indoor (Heating)	H/M/L/Q		45/40/36/-		
	Outdoor (Cooling/Heating)	High		56/58		
Airflow Rate	Indoor/Outdoor (Cooling)	High	m <sup>3</sup> /h	3,550/6,900		
	Indoor/Outdoor (Heating)	High		3,550/7,300		
Static pressure range (Standard)			Pa	60 to 260 (60)		
Net Dimensions	Indoor		mm	425 × 1,250 × 490		
H x W x D	Outdoor		mm	1,290 × 900 × 330		
Weight	Indoor		kg	54		
	Outdoor		kg	104		
Connection Pipe Diameter (Liquid/Gas)			mm	9.52/15.88		
Drain Hose Diameter (I.D./O.D.)				23.4/25.4		
Max. Pipe Length (Pre-Charge)			m	75 (30)		
Max. Height Difference				30		
Operating Range	Cooling		*CDB	-15 to 46		
	Heating		*CDB	-15 to 24		
Refrigerant	Type (Global Warming Potential)			R410A (2,088)		
	Charge	kg (CO2eq-T)			3.45 (7.204)	

## Optional parts

\* For optional parts compatibility of Intesis devices, please refer to the optional parts compatibility list page C-050 to C-053 and C-066.

Wired remote controller:	UTY-RNNYM	Network Converter for single split (DC power supply type):	UTY-VTGX
Wired remote controller:	UTY-RVNYM	Network Converter for single split (AC power supply type):	UTY-VTGXV
External switch controller:	UTY-TERX	External connect kit:	UTD-ECS5A
WLAN adapter:	UTY-TFNXZ1	(Outdoor unit)	
	FG-RC-WIF1Z2	External connect kit:	UTY-XWZXZ2
Remote sensor unit:	UTY-XSZXZ1		
IR receiver unit:	UTY-LRHYM		

## Dimensions

(Unit: mm)

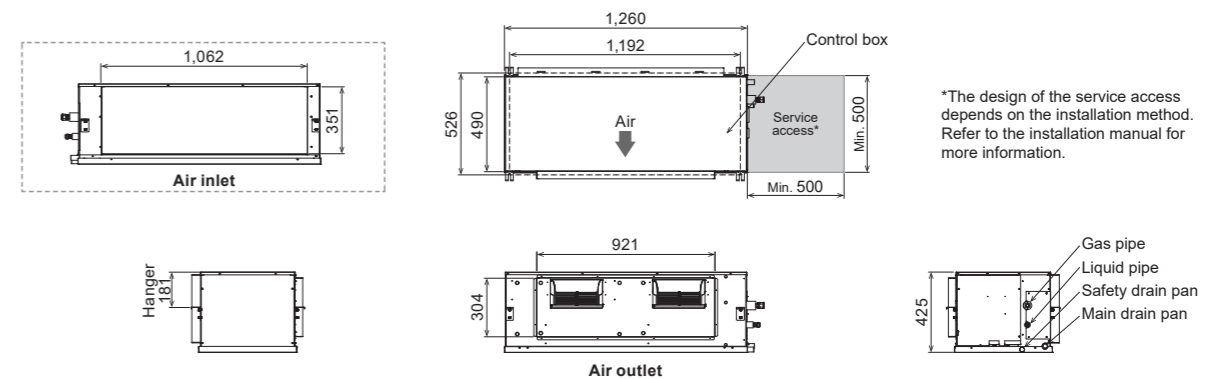

\*The design of the service access depends on the installation method. Refer to the installation manual for more information.



# Big Duct



## Splittable, lightweight, and compact design

The indoor unit can be split into a fan unit and a heat exchanger unit to make installation easier.

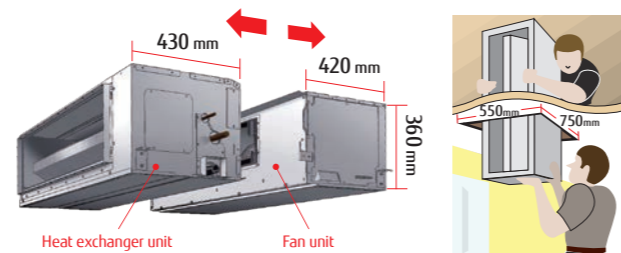

## Quiet operation

The combination of a V-shaped heat exchanger, an air stabilizer, and a high-efficiency DC fan motor enables this compact unit to operate quietly.

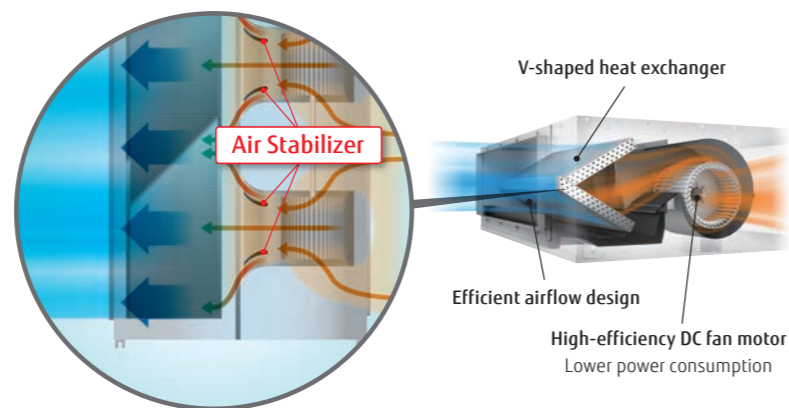

## Automatic airflow adjustment function

The optimum airflow can be set automatically to facilitate faster installation.

Automatically adjust!



Static pressure  
??? Pa  
It was necessary to calculate

## Link up with a variety of central control system (Option)

Centralized control including facilities and equipment in addition to air conditioning is possible by linking up with MODBUS, KNX interfaces.



Model: ARYG72LHTA / ARYG90LHTA



Wired RC



## Specifications

Model name	Indoor unit		ARYG72LHTA		ARYG90LHTA		
	Outdoor unit		AOYG72LRLA		AOYG90LRLA		
Power Source	Indoor		Single phase, ~230 V, 50 Hz				
	Outdoor		3-phase, ~400 V, 50 Hz				
Capacity	Cooling	Rated	kW	19.0		22.0	
		Min.-Max.		8.4-20.9		10.3-24.2	
	Heating	Rated	kW	22.4		27.0	
		Min.-Max.		7.2-24.6		8.5-29.7	
Input Power	Cooling/Heating		kW	6.46/6.59		7.77/8.18	
EER	Cooling		W/W	2.94		2.83	
COP	Heating		W/W	3.40		3.30	
Max. Operating Current	Indoor (Cooling/Heating)		A	-		-	
	Outdoor (Cooling/Heating)		A	-		-	
Moisture Removal			l/h	4.5		6.0	
	Indoor (Cooling)	H/M/L/Q	dB(A)	46/43/41/39		47/44/42/40	
Sound Pressure	Indoor (Heating)	H/M/L/Q	dB(A)	46/43/41/39		47/44/42/40	
	Outdoor (Cooling/Heating)	High	dB(A)	55/55		55/57	
Airflow Rate	Indoor/Outdoor (Cooling)	High	m <sup>3</sup> /h	4,300/8,400		4,300/8,400	
	Indoor/Outdoor (Heating)	High	m <sup>3</sup> /h	4,300/8,400		4,300/9,000	
Static pressure range (Standard)			Pa	50 to 150 (72)		50 to 200 (72)	
Net Dimensions	Indoor	mm	mm	360 × 1,400 × 850		360 × 1,400 × 850	
	Outdoor	mm	mm	1,428 × 1,080 × 480		1,428 × 1,080 × 480	
Weight	Indoor	kg	kg	69		80	
	Outdoor	kg	kg	165		174	
Connection Pipe Diameter (Liquid/Gas)			mm	12.7/25.4		12.7/25.4	
Drain Hose Diameter (I.D./O.D.)			mm	25/32		25/32	
Max. Pipe Length (Pre-Charge)			m	100 (30)		100 (30)	
Max. Height Difference			m	30		30	
Operating Range	Cooling	°CDB	°CDB	-15 to 46		-15 to 46	
	Heating	°CDB	°CDB	-20 to 24		-20 to 24	
Refrigerant	Type (Global Warming Potential)			R410A (2,088)		R410A (2,088)	
	Charge	kg (CO <sub>2</sub> eq-T)	kg (CO <sub>2</sub> eq-T)	5.6 (11.693)		7.1 (14.825)	

## Optional parts

\* For optional parts compatibility of Intesis devices, please refer to the optional parts compatibility list page C-050 to C-053 and C-066.

Wired Remote Controller (Design type):	UTY-RVRY	WLAN adapter:	UTY-TFSXZ1	Network Converter for single split (DC power supply type):	UTY-VTGX
Compact wired remote controller:	UTY-RCRYZ1		FG-RC-WIF1Z2	Network Converter for single split (AC power supply type):	UTY-VTGXV
Wired remote controller (touch panel):	UTY-RNRYZ5		UTY-TFSXJ3	IR receiver unit:	UTY-LBTYM
Wired remote controller:	UTY-RLRY		FG-AC-WIF1Z1	Silver Ion Filter:	UTY-LRHYM
	UTY-RNNYM	External input and output PCB:	UTY-XCSX		UTD-HFKA
	UTY-RVNYM	Remote sensor unit:	UTY-XSZXZ1		
Simple remote controller (without operation mode):	UTY-RHRY	Long-life filter:	UTD-LFKA	(Outdoor unit)	
Simple remote controller:	UTY-RSRY	External connect kit:	UTY-XWZXZG	External connect kit:	UTY-XWZXZ3
External switch controller:	UTY-TERX	Drain pump unit:	UTZ-PXINAB		

## Dimensions

(Unit: mm)

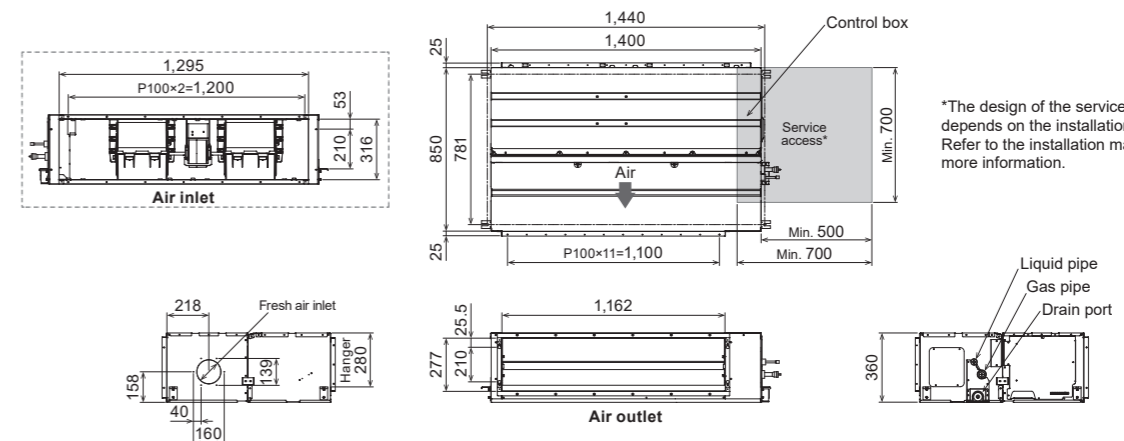

\*The design of the service access depends on the installation method. Refer to the installation manual for more information.

# Floor Compact Size



Model: AGE09KVCA / AGE12KVCA / AGE14KVCA



### Specifications

Model name	Indoor unit		AGE09KVCA	AGE12KVCA	AGE14KVCA
	Outdoor unit		AOE09KVCA	AOE12KVCA	AOE14KVCA
Power Source			Single phase, ~230 V, 50 Hz		
Capacity	Cooling	Rated	2.5	3.5	4.2
		Min.-Max.	0.9-3.5	0.9-4.0	0.9-5.2
	Heating	Rated	3.5	4.5	5.2
Min.-Max.		0.9-5.1	0.9-5.3	0.9-6.3	
Input Power	Cooling/Heating	kW	0.53/0.81	0.88/1.22	1.06/1.41
EER	Cooling		4.70	4.00	3.95
COP	Heating	W/W	4.30	3.70	3.70
Pdesign	Cooling/Heating (-10°C)	kW	2.50/2.60	3.50/3.50	4.20/4.20
SEER	Cooling	W/W	8.50	8.20	8.10
SCOP	Heating (Average)	W/W	4.30	4.10	4.00
Energy Efficiency Class	Cooling		A+++	A++	A+
	Heating (Average)		A+	A+	A+
Max. Operating Current	Cooling/Heating	A	7.0/8.5	7.0/8.5	11.0/12.0
Annual Energy Consumption	Cooling	kWh/a	103	149	181
	Heating (Average)		845	1,192	1,466
Moisture Removal		l/h	1.3	1.8	2.1
Sound Pressure Level	Indoor (Cooling)	H/M/L/Q	40/35/29/22	40/35/29/22	44/38/31/22
	Indoor (Heating)	H/M/L/Q	41/35/29/22	41/35/29/22	43/37/29/22
Sound Power Level	Outdoor (Cooling/Heating)	High	43/47	45/51	51/50
	Indoor (Cooling/Heating)	High	53/54	53/54	57/56
Airflow Rate	Indoor/Outdoor (Cooling)	High	570/1,530	570/1,530	650/2,210
	Indoor/Outdoor (Heating)	High	600/1,510	600/1,510	650/2,100
Net Dimensions H x W x D	Indoor	mm	600 x 740 x 200	600 x 740 x 200	600 x 740 x 200
	Outdoor	mm	542 x 799 x 290	542 x 799 x 290	632 x 799 x 290
Weight	Indoor	kg	14	14	14
	Outdoor	kg	31	31	38
Connection Pipe Diameter (Liquid/Gas)		mm	6.35/9.52	6.35/9.52	6.35/9.52
Drain Hose Diameter (I.D./O.D.)			13.8/15.8 to 16.7	13.8/15.8 to 16.7	13.8/15.8 to 16.7
Max. Pipe Length (Pre-Charge)		m	20 (15)	20 (15)	20 (15)
Max. Height Difference			15	15	15
Operating Range	Cooling	°CDB	-10 to 46	-10 to 46	-10 to 46
	Heating		-15 to 24	-15 to 24	-15 to 24
Refrigerant	Type (Global Warming Potential)		R32 (675)	R32 (675)	R32 (675)
	Charge	kg (CO2eq-T)	0.85 (0.574)	0.85 (0.574)	0.94 (0.635)

### High energy saving

The Floor 09 class achieves a top-class SEER of 8.50 and an A+++ seasonal efficiency rank for cooling. The Floor 09 class achieves an improved SCOP of 4.30 and an A+ seasonal efficiency rank for heating.



### Flexible & easy installation

The compact and whole-surface suction design provides flexible installation options, including floor-standing, embedded, half concealed, and wall mount installation to match the room layout.

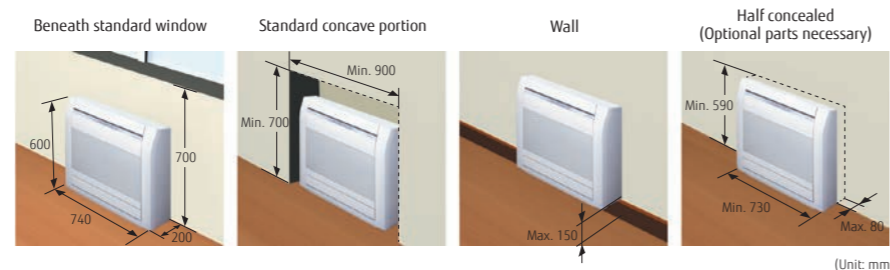

\* Concaved position installation with concealment is prohibited.

### Low ambient operation

Factory-guaranteed cooling operation down to -10°C ambient temperature.

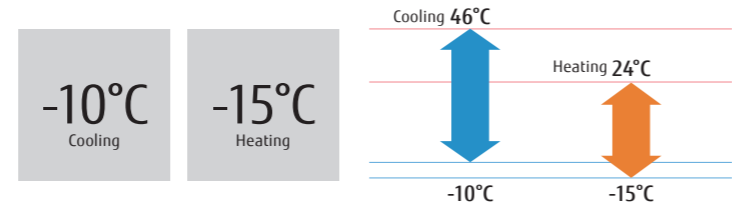

### Smart device control (Option)

With the optional WLAN adapter installed in the air conditioner, you can control it from anywhere with your smart device.

\* See page C-020 for details on smart device control.



### 10°C heat

The room temperature can be set to go no lower than 10°C, thus ensuring that the room does not get too cold when not occupied.

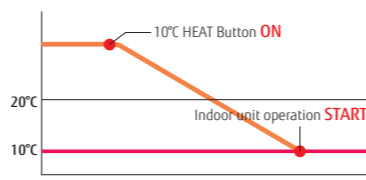

### Optional parts

\* For optional parts compatibility of Intesis devices, please refer to the optional parts compatibility list page C-050 to C-053 and C-066.

- Wired Remote Controller (Design type): UTY-RVRY
- Compact wired remote controller: UTY-RCRYZ1
- Wired remote controller (touch panel): UTY-RNRYZ5
- Wired remote controller: UTY-RLRY
- Simple remote controller (without operation mode): UTY-RHRY
- Simple remote controller: UTY-RSRY
- External switch controller: UTY-TERX
- WLAN adapter: UTY-TFSXZ1
- FG-AC-WIF1Z1
- UTY-TFSXJ3
- UTR-STA
- UTY-TWRXZ3
- Network Converter for single split (DC power supply type): UTY-VTGX
- Network Converter for single split (AC power supply type): UTY-VTGXV
- Silver Ion Filter: UTR-FA03-5
- External connect kit: UTY-XWZX25

### Dimensions

(Unit: mm)

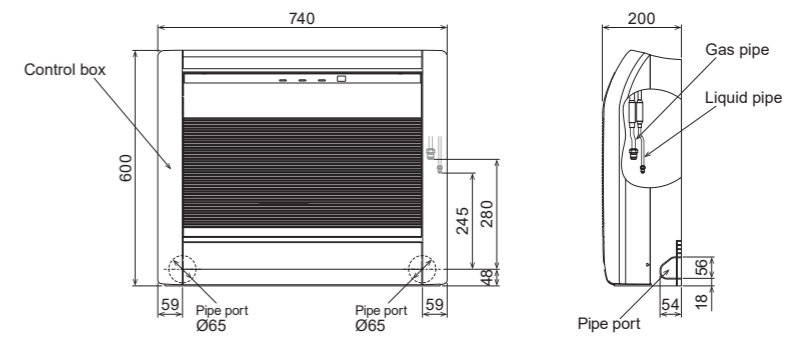



# Ceiling

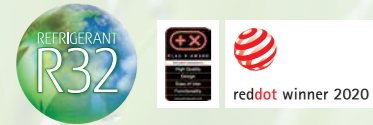

## Light elegant design

The light-elegant, gently curved surface gives a sense of comfort and well-being.



## Easy installation

The indoor unit can be easily installed under the ceiling thanks to the uniquely designed mounting kit.

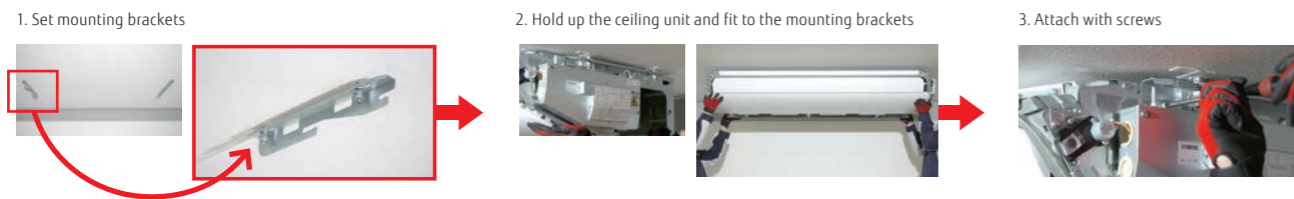

## Easy maintenance

The front panel can be opened without removing it for safe & speedy maintenance.



The drain pan can be removed for cleaning.



Components in the control box can be easily accessed from the wide side opening.



## Flexible installation

The drain hose and pipe can be contained in the casing and connected in the right, left, angled, or downward direction.



## Link up with a variety of central control system (Option)

Centralized control including facilities and equipment in addition to air conditioning is possible by linking up with MODBUS, KNX interfaces.



Model: ABEG18KRTA / ABEG22KRTA / ABEG24KRTA / ABEG30KRTA / ABEG36KRTA / ABEG45KRTA / ABEG36KRTA [3-phase] / ABEG45KRTA [3-phase] / ABEG54KRTA [3-phase]



## Specifications

Model name	Indoor unit		ABEG18KRTA			ABEG22KRTA			ABEG24KRTA			ABEG30KRTA			ABEG36KRTA			ABEG45KRTA			ABEG36KRTA			ABEG45KRTA			ABEG54KRTA		
	Outdoor unit		AOEG18KBTB	AOEG22KBTB	AOEG24KBTB	AOEG30KBTB	AOEG36KBTB	AOEG45KBTB	AOEG36KRTA	AOEG45KRTA	AOEG54KRTA	AOEG36KRTA	AOEG45KRTA	AOEG54KRTA	AOEG36KRTA	AOEG45KRTA	AOEG54KRTA	AOEG36KRTA	AOEG45KRTA	AOEG54KRTA	AOEG36KRTA	AOEG45KRTA	AOEG54KRTA						
Power Source	Single phase, ~230 V, 50 Hz															3-phase, ~400 V, 50 Hz													
Capacity	Cooling	Rated	5.2		6.0		6.8		8.5		9.5		12.1		9.5		12.1		13.4		9.5		12.1		13.4				
		Min.-Max.	0.9-5.9		0.9-6.7		0.9-8.0		2.8-10.0		2.8-11.2		4.0-13.5		2.8-11.2		4.0-13.5		4.5-14.5		2.8-11.2		4.0-13.5		4.5-14.5				
	Heating	Rated	6.0		7.0		7.5		10.0		10.8		13.5		10.8		13.5		15.5		10.8		13.5		15.5				
Input Power	Cooling/Heating	Min.-Max.	0.9-7.5		0.9-8.0		0.9-9.1		2.7-11.2		2.7-12.7		4.2-16.2		2.7-12.7		4.2-16.2		4.7-16.5		2.7-12.7		4.2-16.2		4.7-16.5				
		Rated	1.55/1.62		1.87/1.95		2.14/1.97		2.65/2.77		2.96/2.88		4.22/3.84		2.96/2.88		4.22/3.84		4.45/4.43		2.96/2.88		4.22/3.84		4.45/4.43				
	W/W	3.35		3.21		3.18		3.21		3.21		2.87		3.21		2.87		3.01		3.21		2.87		3.01					
EER	Cooling	3.70		3.59		3.81		3.61		3.75		3.52		3.75		3.52		3.50		3.75		3.52		3.50					
	Heating	6.2		6.1		6.2		6.1		6.37		-		6.37		-		-		6.37		-		-					
Pdesign	Cooling/Heating (-10°C)	5.2/4.4		6.0/4.8		6.8/6.0		8.5/8.0		9.5/8.7		-		9.5/8.7		-		-		9.5/8.7		-		-					
	W/W	6.2		6.1		6.2		6.1		6.37		-		6.37		-		-		6.37		-		-					
SEER	Cooling	4.1		4.0		4.1		4.0		4.21		-		4.21		-		-		4.21		-		-					
	Heating (Average)	A++		A++		A++		A++		A++		-		A++		-		-		A++		-		-					
SCOP	Cooling	A+		A+		A+		A+		A+		-		A+		-		-		A+		-		-					
	Heating (Average)	12.1/12.1		12.6/12.6		13.6/13.6		22.6/22.6		22.6/22.6		28.5/28.5		10.5/10.5		14.0/14.0		14.0/14.0		10.5/10.5		14.0/14.0		14.0/14.0					
Annual Energy Consumption	Cooling	293		344		384		486		524		-		524		-		-		524		-		-					
	Heating	1.501		1.677		2.042		2.796		2.904		-		2.904		-		-		2.904		-		-					
Moisture Removal	Cooling	2.0		2.5		2.2		3.0		2.6		4.5		2.6		4.5		5.0		2.6		4.5		5.0					
	Heating	38/36/33/31		42/37/34/31		41/36/32/29		45/40/35/32		44/40/37/32		45/41/39/34		44/40/37/32		45/41/39/34		48/44/41/38		44/40/37/32		45/41/39/34		48/44/41/38					
Sound Pressure Level	Indoor (Cooling)	H/M/L/Q		38/36/33/31		42/37/34/31		41/36/32/29		45/40/35/32		44/40/37/32		45/41/39/34		44/40/37/32		45/41/39/34		48/44/41/38		44/40/37/32		45/41/39/34		48/44/41/38			
	Outdoor (Cooling/Heating)	High		50/50		51/51		53/54		53/55		55/55		57/57		55/55		57/57		57/59		55/55		57/57		57/59			
Sound Power Level	Indoor (Cooling/Heating)	High		53/53		57/57		56/56		60/60		59/59		60/60		59/59		60/60		63/63		59/59		60/60		63/63			
	Outdoor (Cooling/Heating)	High		62/62		63/63		65/66		68/69		70/70		71/71		70/70		71/71		73/73		70/70		71/71		73/73			
Airflow Rate	Indoor/Outdoor (Cooling)	High		840/2,160		900/2,240		1,230/2,700		1,400/3,750		1,850/3,750		1,900/4,450		1,850/3,750		1,900/4,450		2,100/4,450		1,850/3,750		1,900/4,450		2,100/4,450			
	Indoor/Outdoor (Heating)	High		840/1,830		900/1,960		1,230/2,700		1,400/3,750		1,800/3,750		1,850/4,450		1,800/3,750		1,850/4,450		2,100/4,450		1,800/3,750		1,850/4,450		2,100/4,450			
Net Dimensions	Indoor	mm		235 × 1,080 × 705		235 × 1,080 × 705		235 × 1,390 × 705		235 × 1,390 × 705		235 × 1,700 × 705		235 × 1,700 × 705		235 × 1,700 × 705		235 × 1,700 × 705		235 × 1,700 × 705		235 × 1,700 × 705		235 × 1,700 × 705		235 × 1,700 × 705			
	Outdoor	mm		632 × 799 × 290		632 × 799 × 290		716 × 820 × 315		788 × 940 × 320		788 × 940 × 320		998 × 940 × 320		788 × 940 × 320		998 × 940 × 320		998 × 940 × 320		788 × 940 × 320		998 × 940 × 320		998 × 940 × 320			
Weight	Indoor	kg		24		24		31		31		38		38		38		38		38		38		38		38			
	Outdoor	kg		36		38		42		52		52		67		53		67		67		53		67		67			
Connection Pipe Diameter (Liquid/Gas)	Indoor	mm		6.35/12.7		6.35/12.7		6.35/12.7		9.52/15.88		9.52/15.88		9.52/15.88		9.52/15.88		9.52/15.88		9.52/15.88		9.52/15.88		9.52/15.88		9.52/15.88			
	Outdoor	mm		25/32		25/32		25/32		25/32		25/32		25/32		25/32		25/32		25/32		25/32		25/32		25/32			
Max. Pipe Length (Pre-Charge)	Cooling	m		30 (20)		30 (20)		30 (20)		50 (30)		50 (30)		50 (30)		50 (30)		50 (30)		50 (30)		50 (30)		50 (30)		50 (30)			
	Heating	m		20		25		25		30		30		30		30		30		30		30		30		30			
Operating Range	Cooling	°CDB		-15 to 46		-15 to 46		-15 to 46		-15 to 46		-15 to 46		-15 to 46		-15 to 46		-15 to 46		-15 to 46		-15 to 46		-15 to 46		-15 to 46			
	Heating	°CDB		-15 to 24		-15 to 24		-15 to 24		-15 to 24		-15 to 24		-15 to 24		-15 to 24		-15 to 24		-15 to 24		-15 to 24		-15 to 24		-15 to 24			
Refrigerant	Type (Global Warming Potential)	R32 (675)		R32 (675)		R32 (675)		R32 (675)		R32 (675)		R32 (675)		R32 (675)		R32 (675)		R32 (675)		R32 (675)		R32 (675)		R32 (675)		R32 (675)			
	Charge	kg (CO2eq-T)		1.02 (0.689)		1.25 (0.844)		1.25 (0.844)		1.90 (1.283)		1.90 (1.283)		2.70 (1.823)		1.90 (1.283)		2.70 (1.823)		2.70 (1.823)		1.90 (1.283)		2.70 (1.823)		2.70 (1.823)			

## Optional parts

\* For optional parts compatibility of Intesis devices, please refer to the optional parts compatibility list page C-050 to C-053 and C-066.

Wired Remote Controller (Design type):	UTY-RVRY	WLAN adapter:	UTY-TFSXZ1	Network Converter for single split (DC power supply type):	UTY-VTGX
Compact wired remote controller:	UTY-RCRYZ1		UTY-TFSXJ3	Network Converter for single split (AC power supply type):	UTY-VTGVX
Wired remote controller (touch panel):	UTY-RNRYZ5		FG-AC-WIF1Z1	External switch controller:	UTY-TERX
Wired remote controller:	UTY-RLRY	Drain pump unit:	UTR-DPB24T	External connect kit:	UTY-XWZXZG
Simple remote controller (without operation mode):	UTY-RHRY	IR receiver unit:	UTY-LBTYH	(Outdoor unit 30/36/45/54)	
Simple remote controller:	UTY-RSRY	L-type piping kit:	UTP-FX24A (18/22/24)	External connect kit:	UTY-XWZXZ3
External input and output PCB:	UTY-XCSX		UTP-FX35A (30/36/45/54)		
External input and output PCB box:	UTZ-GXEA	Communication kit:	UTY-TWRXZ3		

## Dimensions

(Unit: mm)

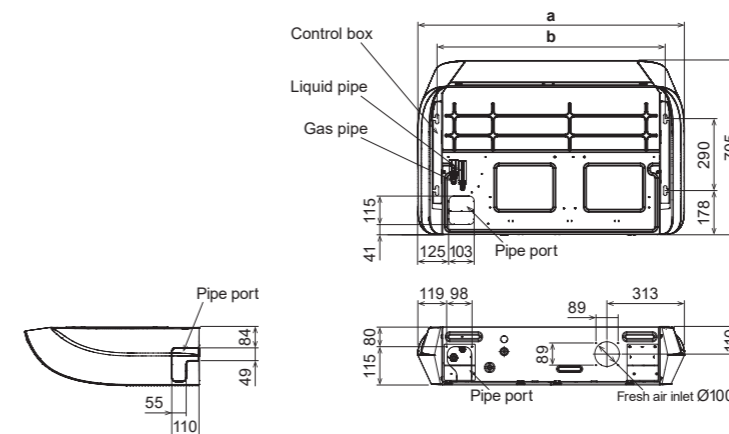

	ABEG 18/22KRTA	ABEG 24/30KRTA	ABEG 36/45/54 KRTA
a	1,080	1,390	1,700
b	923	1,233	1,543



## Wall-mounted Specifications

### Designer Series High-Spec & Design (WLAN adapter Internal Models)

Model name	Indoor unit		ASYG07KGTG	ASYG09KGTG	ASYG12KGTG	ASYG14KGTG	
	Outdoor unit		AOYG07KGCB	AOYG09KGCB	AOYG12KGCB	AOYG14KGCB	
Power Source			Single phase, ~230 V, 50 Hz				
Capacity	Cooling	Rated	2.0	2.5	3.4	4.2	
		Min.-Max.	0.9-3.2	0.9-3.4	0.9-4.1	0.9-4.5	
	Heating	Rated	2.5	2.8	4.0	5.4	
		Min.-Max.	0.9-5.2	0.9-5.4	0.9-6.1	0.9-6.4	
Input Power		Cooling/Heating	0.400/0.500	0.555/0.560	0.805/0.910	1.175/1.350	
EER		Cooling	5.00	4.50	4.22	3.57	
COP		Heating	5.00	5.00	4.40	4.00	
Pdesign		Cooling/Heating (-10°C)	2.0/2.3	2.5/2.4	3.4/2.5	4.2/4.0	
SEER		Cooling	8.10	8.90	8.70	7.90	
SCOP		Heating (Average)	5.30	5.20	5.20	4.50	
Energy Efficiency Class		Cooling	A++	A+++	A+++	A++	
		Heating (Average)	A+++	A+++	A+++	A+	
Max. Operating Current		Cooling/Heating	6.5/9.0	6.5/9.0	6.5/9.0	9.0/10.5	
Annual Energy Consumption		Cooling	86	98	137	186	
		Heating	606	645	673	1,242	
Moisture Removal			l/h	1.0	1.3	1.8	
Sound Pressure Level		Indoor (Cooling)	H/M/L/Q	38/33/29/19	40/34/29/19	40/35/30/19	43/36/30/20
		Indoor (Heating)	H/M/L/Q	41/35/31/21	42/36/31/21	42/38/33/21	44/39/33/24
		Outdoor (Cooling/Heating)	High	46/46	46/48	50/50	50/50
		Indoor (Cooling/Heating)	High	54/56	55/57	56/58	57/59
Sound Power Level		Outdoor (Cooling/Heating)	High	61/62	61/63	65/66	65/66
Airflow Rate		Indoor/Outdoor (Cooling)	High	650/1,610	700/1,610	700/1,680	770/1,680
		Indoor/Outdoor (Heating)	High	720/1,560	750/1,610	770/1,580	800/1,580
Net Dimensions H x W x D		Indoor	mm	270 x 834 x 215	270 x 834 x 215	270 x 834 x 215	270 x 834 x 215
		Outdoor	mm	542 x 799 x 290	542 x 799 x 290	542 x 799 x 290	542 x 799 x 290
Weight		Indoor	kg	10	10	10	10
		Outdoor	kg	30	30	31	32
Connection Pipe Diameter (Liquid/Gas)			mm	6.35/9.52			
Drain Hose Diameter (I.D./O.D.)			mm	13.8/15.0 to 16.8			
Max. Pipe Length (Pre-Charge)			m	20 (15)			
Max. Height Difference				15			
Operating Range		Cooling	°CDB	-10 to 46			
		Heating	°CDB	-15 to 24			
Refrigerant		Type (Global Warming Potential)		R32 (675)			
		Charge	kg (CO2eq-T)	0.75 (0.506)	0.75 (0.506)	0.85 (0.574)	0.85 (0.574)

### Designer Series High Spec & Design (WLAN adapter Option Models)

Model name	Indoor unit		ASYG07KGTE	ASYG09KGTE	ASYG12KGTE	ASYG14KGTE	
	Outdoor unit		AOYG07KGCA	AOYG09KGCA	AOYG12KGCA	AOYG14KGCA	
Power Source			Single phase, ~230 V, 50 Hz				
Capacity	Cooling	Rated	2.0	2.5	3.4	4.2	
		Min.-Max.	0.9-3.2	0.9-3.4	0.9-4.1	0.9-4.5	
	Heating	Rated	2.5	2.8	4.0	5.4	
		Min.-Max.	0.9-5.2	0.9-5.4	0.9-6.1	0.9-6.4	
Input Power		Cooling/Heating	0.400/0.500	0.555/0.560	0.805/0.910	1.175/1.350	
EER		Cooling	5.00	4.50	4.22	3.57	
COP		Heating	5.00	5.00	4.40	4.00	
Pdesign		Cooling/Heating (-10°C)	2.0/2.3	2.5/2.4	3.4/2.5	4.2/4.0	
SEER		Cooling	9.10	9.20	9.20	8.30	
SCOP		Heating (Average)	5.30	5.20	5.20	4.50	
Energy Efficiency Class		Cooling	A+++	A+++	A+++	A++	
		Heating (Average)	A+++	A+++	A+++	A+	
Max. Operating Current		Cooling/Heating	6.5/9.0	6.5/9.0	6.5/9.0	9.0/10.5	
Annual Energy Consumption		Cooling	77	95	129	177	
		Heating	607	645	672	1,242	
Moisture Removal			l/h	1.0	1.3	1.8	
Sound Pressure Level		Indoor (Cooling)	H/M/L/Q	38/33/29/19	40/34/29/19	40/35/30/19	43/36/30/20
		Indoor (Heating)	H/M/L/Q	41/35/31/21	42/36/31/21	42/38/33/21	44/39/33/24
		Outdoor (Cooling/Heating)	High	46/46	46/48	50/50	50/50
		Indoor (Cooling/Heating)	High	54/56	55/57	56/58	57/59
Sound Power Level		Outdoor (Cooling/Heating)	High	61/62	61/63	65/66	65/66
Airflow Rate		Indoor/Outdoor (Cooling)	High	650/1,610	700/1,610	700/1,680	770/1,680
		Indoor/Outdoor (Heating)	High	720/1,560	750/1,610	770/1,580	800/1,580
Net Dimensions H x W x D		Indoor	mm	270 x 834 x 215	270 x 834 x 215	270 x 834 x 215	270 x 834 x 215
		Outdoor	mm	542 x 799 x 290	542 x 799 x 290	542 x 799 x 290	542 x 799 x 290
Weight		Indoor	kg	10	10	10	10
		Outdoor	kg	30	30	31	32
Connection Pipe Diameter (Liquid/Gas)			mm	6.35/9.52			
Drain Hose Diameter (I.D./O.D.)			mm	13.8/15.0 to 16.8			
Max. Pipe Length (Pre-Charge)			m	20 (15)			
Max. Height Difference				15			
Operating Range		Cooling	°CDB	-10 to 46			
		Heating	°CDB	-15 to 24			
Refrigerant		Type (Global Warming Potential)		R32 (675)			
		Charge	kg (CO2eq-T)	0.75 (0.506)	0.75 (0.506)	0.85 (0.574)	0.85 (0.574)



**Designer Series**  
Cool Beauty Design



Model name	Indoor unit		ASYG07KETE ASYG07KETE-B	ASYG09KETE ASYG09KETE-B	ASYG12KETE ASYG12KETE-B	ASYG14KETE ASYG14KETE-B
	Outdoor unit		AOYG07KETA	AOYG09KETA	AOYG12KETA	AOYG14KETA
Power Source			Single phase, ~230 V, 50 Hz			
Capacity	Cooling	Rated	2.0	2.5	3.4	4.2
		Min.-Max.	0.9 - 3.0	0.9 - 3.2	0.9 - 3.9	0.9 - 4.4
	Heating	Rated	2.5	2.8	4.0	5.4
		Min.-Max.	0.9 - 3.4	0.9 - 4.0	0.9 - 5.3	0.9 - 6.0
Input Power	Cooling/Heating		0.450/0.555	0.630/0.620	0.935/0.960	1.220/1.410
EER	Cooling		4.43	3.97	3.65	3.44
COP	Heating		4.52	4.52	4.17	3.83
Pdesign	Cooling/Heating (-10°C)		2.0/2.3	2.5/2.4	3.4/2.5	4.2/4.0
SEER	Cooling		7.40	7.40	7.30	6.90
SCOP	Heating (Average)		4.10	4.10	4.40	4.10
Energy Efficiency Class	Cooling		A++	A++	A++	A++
	Heating (Average)		A+	A+	A+	A+
Max. Operating Current	Cooling/Heating		6.5/9.0	6.5/9.0	6.5/9.0	6.5/9.0
Annual Energy Consumption	Cooling		95	118	163	213
	Heating		785	819	795	1,367
Moisture Removal			1.0	1.3	1.8	2.1
Sound Pressure Level	Indoor (Cooling)	H/M/L/Q	38/33/29/20	40/34/29/20	40/35/30/20	43/36/30/20
	Indoor (Heating)	H/M/L/Q	41/35/31/22	42/36/31/22	42/38/33/22	44/39/33/24
Sound Power Level	Outdoor (Cooling/Heating)	High	46/46	46/46	50/50	50/50
	Indoor (Cooling/Heating)	High	54/56	55/57	55/58	57/59
Airflow Rate	Indoor/Outdoor (Cooling)	High	650/1,650	700/1,650	700/1,700	770/1,680
	Indoor/Outdoor (Heating)	High	720/1,450	750/1,450	770/1,470	800/1,580
Net Dimensions H x W x D	Indoor	mm	295 × 950 (wall side: 840) × 230			
Weight	Outdoor	mm	541 × 663 × 290	541 × 663 × 290	541 × 663 × 290	542 × 799 × 290
	Indoor	kg	11	11	11	11.5
Connection Pipe Diameter (Liquid/Gas)	Indoor	kg	23	23	25	31
	Outdoor	mm	6.35/9.52	6.35/9.52	6.35/9.52	6.35/9.52
Drain Hose Diameter (I.D./O.D.)			13.8/15.0 to 16.8	13.8/15.0 to 16.8	13.8/15.0 to 16.8	13.8/15.0 to 16.8
Max. Pipe Length (Pre-Charge)			20 (15)	20 (15)	20 (15)	20 (15)
Max. Height Difference			15	15	15	15
Operating Range	Cooling		-10 to 46	-10 to 46	-10 to 46	-10 to 46
	Heating		-15 to 24	-15 to 24	-15 to 24	-15 to 24
Refrigerant	Type (Global Warming Potential)		R32 (675)	R32 (675)	R32 (675)	R32 (675)
	Charge		0.6 (0.405)	0.6 (0.405)	0.7 (0.473)	0.85 (0.574)

**Standard Series**  
High-Efficiency & Comfort



Model name	Indoor unit	W-LAN Adapter Internal Models	ASYG07KMCF	ASYG09KMCF	ASYG12KMCF	ASYG14KMCF
		W-LAN Adapter Option Models	ASYG07KMCE	ASYG09KMCE	ASYG12KMCE	ASYG14KMCE
		Outdoor unit	AOYG07KMCC	AOYG09KMCC	AOYG12KMCC	AOYG14KMCC
Power Source			Single phase, ~230 V, 50 Hz			
Capacity	Cooling	Rated	2.0	2.5	3.4	4.2
		Min.-Max.	0.9-3.0	0.9-3.2	0.9-3.9	0.9-4.4
	Heating	Rated	2.5	2.8	4.0	5.4
		Min.-Max.	0.9-3.4	0.9-4.0	0.9-5.3	0.9-6.0
Input Power	Cooling/Heating		0.450/0.555	0.630/0.620	0.935/0.960	1.220/1.410
EER	Cooling		4.43	3.97	3.65	3.44
COP	Heating		4.52	4.52	4.17	3.83
Pdesign	Cooling/Heating (-10°C)		2.0/2.3	2.5/2.4	3.4/2.5	4.2/4.0
SEER	Cooling		7.40	7.40	7.30	6.90
SCOP	Heating (Average)		4.10	4.10	4.40	4.10
Energy Efficiency Class	Cooling		A++	A++	A++	A++
	Heating (Average)		A+	A+	A+	A+
Max. Operating Current	Cooling/Heating		6.5/9.0	6.5/9.0	6.5/9.0	6.5/9.0
Annual Energy Consumption	Cooling		95	118	163	213
	Heating		785	819	795	1367
Moisture Removal			1.0	1.3	1.8	2.1
Sound Pressure Level	Indoor (Cooling)	H/M/L/Q	38/33/29/20	40/34/29/20	40/35/30/20	43/36/30/20
	Indoor (Heating)	H/M/L/Q	41/35/31/22	42/36/31/22	42/38/33/22	44/39/33/24
Sound Power Level	Outdoor (Cooling/Heating)	High	46/46	46/46	50/50	50/50
	Indoor (Cooling/Heating)	High	54/56	55/57	55/58	57/59
Airflow Rate	Indoor/Outdoor (Cooling)	High	650/1,650	700/1,650	700/1,700	770/1,680
	Indoor/Outdoor (Heating)	High	720/1,450	750/1,450	780/1,470	820/1,580
Net Dimensions H x W x D	Indoor	mm	270 × 834 × 222	270 × 834 × 222	270 × 834 × 222	270 × 834 × 222
Weight	Outdoor	mm	541 × 663 × 290	541 × 663 × 290	541 × 663 × 290	542 × 799 × 290
	Indoor	kg	10	10	10	10
Connection Pipe Diameter (Liquid/Gas)	Outdoor	kg	22	22	24	31
	Indoor	mm	6.35/9.52	6.35/9.52	6.35/9.52	6.35/9.52
Drain Hose Diameter (I.D./O.D.)			13.8/15.0 to 16.8	13.8/15.0 to 16.8	13.8/15.0 to 16.8	13.8/15.0 to 16.8
Max. Pipe Length (Pre-Charge)			20 (15)	20 (15)	20 (15)	20 (15)
Max. Height Difference			15	15	15	15
Operating Range	Cooling		-10 to 46	-10 to 46	-10 to 46	-10 to 46
	Heating		-15 to 24	-15 to 24	-15 to 24	-15 to 24
Refrigerant	Type (Global Warming Potential)		R32 (675)	R32 (675)	R32 (675)	R32 (675)
	Charge		0.6 (0.405)	0.6 (0.405)	0.7 (0.473)	0.85 (0.574)

**ECO Series Lineup**  
Specifications



Compact Cassette



Model name	Indoor unit			AUXG09KVL A	AUXG12KVL A	AUXG14KVL A	AUXG18KVL A	AUXG22KVL A	AUXG24KVL A	
	Outdoor unit			AOEG09KATA	AOEG12KATA	AOEG14KATA	AOEG18KATA	AOEG22KATA	AOEG24KATA	
Power Source	Single phase, ~230 V, 50 Hz									
Capacity	Cooling	Rated	kW	2.5	3.5	4.3	5.2	6.0	6.8	
		Min.-Max.		0.9-2.7	0.9-3.7	0.9-4.5	0.9-5.4	0.9-6.3	0.9-7.4	
	Heating	Rated		3.2	4.1	5.0	6.0	7.0	7.5	
		Min.-Max.		0.9-3.9	0.9-4.4	0.9-5.3	0.9-6.3	0.9-7.4	0.9-8.6	
Input Power	Cooling/Heating		kW	0.68/0.88	1.09/1.17	1.37/1.42	1.69/1.72	1.95/2.00	2.26/2.08	
EER	Cooling		W/W	3.68	3.21	3.14	3.08	3.08	3.01	
COP	Heating		W/W	3.64	3.50	3.52	3.49	3.50	3.61	
Pdesign	Cooling/Heating (-10°C)		kW	2.5/2.3	3.5/2.8	4.3/3.2	5.2/3.8	6.0/4.4	6.8/5.4	
SEER	Cooling		W/W	6.2	6.1	6.1	6.1	6.1	5.9	
SCOP	Heating		W/W	4.0	4.0	4.0	3.9	3.9	3.8	
Energy Efficiency Class	Cooling			A++	A++	A++	A++	A++	A+	
	Heating			A+	A+	A+	A	A	A	
Max. Operating Current	Cooling/Heating		A	6.9/6.9	7.7/7.7	9.2/9.2	10.1/10.1	11.6/11.6	12.6/12.6	
Annual Energy Consumption	Cooling		kWh/a	141	201	247	298	344	403	
	Heating		kWh/a	804	979	1,120	1,362	1,578	1,988	
Moisture Removal			l/h	0.6	1.2	1.5	2.2	2.6	2.7	
	Indoor (Cooling)	H/M/L/Q		33/31/29/27	37/34/30/27	38/34/30/27	38/34/30/26	44/42/36/30	49/44/36/30	
Sound Pressure Level	Indoor (Heating)	H/M/L/Q		34/32/29/27	37/34/31/29	43/38/34/30	43/38/34/30	45/43/40/33	49/45/40/33	
	Outdoor (Cooling/Heating)	High		47/48	49/50	50/51	51/52	52/53	54/55	
Sound Power Level	Indoor (Cooling/Heating)	High		46/47	49/49	50/55	50/55	56/57	59/61	
	Outdoor (Cooling/Heating)	High		60/60	62/62	63/63	63/64	64/65	66/67	
Airflow Rate	Indoor/Outdoor (Cooling)	High	m³/h	540/1,610	600/1,630	680/1,670	680/1,710	830/2,240	930/2,885	
	Indoor/Outdoor (Heating)	High	m³/h	540/1,550	600/1,410	800/1,580	800/1,840	860/2,240	930/2,350	
Net Dimensions H x W x D	Indoor	mm		245 x 570 x 570	245 x 570 x 570	245 x 570 x 570	245 x 570 x 570	245 x 570 x 570	245 x 570 x 570	
	Outdoor	mm		541 x 663 x 290	541 x 663 x 290	542 x 799 x 290	542 x 799 x 290	632 x 799 x 290	632 x 799 x 290	
Weight	Indoor	kg		15	15	15	15	16	16	
	Outdoor	kg		23	25	32	33	36	38	
Connection Pipe Diameter (Liquid/Gas)	mm			6.35/9.52	6.35/9.52	6.35/9.52	6.35/12.70	6.35/12.70	6.35/12.70	
Drain port Diameter (I.D./O.D.)	mm			25/32	25/32	25/32	25/32	25/32	25/32	
Max. Pipe Length (Pre-Charge)	m			15 (15)	15 (15)	20 (15)	20 (15)	25 (15)	25 (20)	
Max. Height Difference	m			15	15	15	15	20	20	
Operating Range	Cooling	°CDB		-10 to 46	-10 to 46	-10 to 46	-10 to 46	-10 to 46	-10 to 46	
	Heating		-15 to 24	-15 to 24	-15 to 24	-15 to 24	-15 to 24	-15 to 24		
Refrigerant	Type (Global Warming Potential)			R32 (675)	R32 (675)	R32 (675)	R32 (675)	R32 (675)	R32 (675)	
	Charge		kg (CO2eq-T)	0.6 (0.405)	0.7 (0.473)	0.85 (0.574)	0.9 (0.608)	1.1 (0.743)	1.25 (0.844)	
Cassette Grille	Model name			UTG-UKYA-W: White wired remote controller (touch panel)					UTG-UKYA-W: White wired remote controller (touch panel)	
	Dimensions (H x W x D)		mm	49 x 620 x 620	49 x 620 x 620	49 x 620 x 620	49 x 620 x 620	49 x 620 x 620	49 x 620 x 620	49 x 620 x 620
Cassette Grille	Weight		kg	2.3	2.3	2.3	2.3	2.3	2.3	

Circular Cassette (Large type)



Model name	Indoor unit			AUXG30KRL B	AUXG36KRL B	AUXG45KRL B	AUXG54KRL B	AUXG36KRL B	AUXG45KRL B	AUXG54KRL B
	Outdoor unit			AOEG30KATA	AOEG36KATA	AOEG45KATA	AOEG54KATA	AOEG36KQTA	AOEG45KQTA	AOEG54KQTA
Power Source	Single phase, ~230 V, 50 Hz									
Capacity	Cooling	Rated	kW	8.5	9.5	12.1	13.4	9.5	12.1	13.4
		Min.-Max.		2.8-9.6	2.8-10.6	4.0-12.6	4.5-13.8	2.8-10.6	4.0-12.6	4.5-13.8
	Heating	Rated		10.0	10.8	13.5	15.5	10.8	13.5	15.5
		Min.-Max.		2.7-10.8	2.7-12.5	4.2-15.0	4.7-16.0	2.7-12.5	4.2-15.0	4.7-16.0
Input Power	Cooling/Heating		kW	2.56/2.64	3.06/2.58	4.32/3.77	4.87/4.86	3.06/2.58	4.32/3.77	4.87/4.86
EER	Cooling		W/W	3.32	3.10	2.80	2.75	3.10	2.80	2.75
COP	Heating		W/W	3.79	4.19	3.58	3.19	4.19	3.58	3.19
Pdesign	Cooling/Heating (-10°C)		kW	8.5/8.0	9.5/8.7	-	-	9.5/8.7	-	-
SEER	Cooling		W/W	6.1	6.1	-	-	6.1	-	-
SCOP	Heating		W/W	4.0	4.0	-	-	4.0	-	-
Energy Efficiency Class	Cooling			A++	A++	-	-	A++	-	-
	Heating			A+	A+	-	-	A+	-	-
Max. Operating Current	Cooling/Heating		A	22.5/22.5	22.5/22.5	28.1/28.1	28.1/28.1	10.5/10.5	13.6/13.6	13.6/13.6
Annual Energy Consumption	Cooling		kWh/a	488	545	-	-	545	-	-
	Heating		kWh/a	2,794	3,044	-	-	3,044	-	-
Moisture Removal			l/h	2.5	3.3	4.5	5.0	3.3	4.5	5.0
	Indoor (Cooling)	H/M/L/Q		40/38/36/33	44/41/38/34	46/42/39/35	47/43/40/36	44/41/38/34	46/42/39/35	47/43/40/36
Sound Pressure Level	Indoor (Heating)	H/M/L/Q		40/38/36/33	44/41/38/34	46/42/39/35	47/43/40/36	44/41/38/34	46/42/39/35	47/43/40/36
	Outdoor (Cooling/Heating)	High		53/55	55/55	58/59	58/61	55/55	60/60	61/61
Sound Power Level	Indoor (Cooling/Heating)	High		54/54	58/58	60/60	61/61	58/58	-/-	-/-
	Outdoor (Cooling/Heating)	High		68/69	70/70	72/73	74/75	70/70	72/73	74/75
Airflow Rate	Indoor/Outdoor (Cooling)	High	m³/h	1,600/3,750	1,870/3,750	2,000/4,450	2,100/4,450	1,870/3,750	2,000/4,450	2,100/4,450
	Indoor/Outdoor (Heating)	High	m³/h	1,600/3,750	1,870/3,750	2,000/4,450	2,100/4,780	1,870/3,750	2,000/4,450	2,100/4,780
Net Dimensions H x W x D	Indoor	mm		288 x 840 x 840	288 x 840 x 840	288 x 840 x 840	288 x 840 x 840	288 x 840 x 840	288 x 840 x 840	288 x 840 x 840
	Outdoor	mm		788 x 940 x 320	788 x 940 x 320	998 x 940 x 320	998 x 940 x 320	788 x 940 x 320	998 x 940 x 320	998 x 940 x 320
Weight	Indoor	kg		26	29	29	29	29	29	29
	Outdoor	kg		52	52	61	63	53	62	63
Connection Pipe Diameter (Liquid/Gas)	mm			9.52/15.88	9.52/15.88	9.52/15.88	9.52/15.88	9.52/15.88	9.52/15.88	9.52/15.88
Drain port Diameter (I.D./O.D.)	mm			25/32	25/32	25/32	25/32	25/32	25/32	25/32
Max. Pipe Length (Pre-Charge)	m			30 (30)	30 (30)	30 (30)	30 (30)	30 (30)	30 (30)	30 (30)
Max. Height Difference	m			30	30	30	30	30	30	30
Operating Range	Cooling	°CDB		-10 to 46	-10 to 46	-10 to 46	-10 to 46	-10 to 46	-10 to 46	-10 to 46
	Heating		-15 to 24	-15 to 24	-15 to 24	-15 to 24	-15 to 24	-15 to 24	-15 to 24	
Refrigerant	Type (Global Warming Potential)			R32 (675)	R32 (675)	R32 (675)	R32 (675)	R32 (675)	R32 (675)	R32 (675)
	Charge		kg (CO2eq-T)	1.90 (1.283)	1.90 (1.283)	2.4 (1.620)	2.4 (1.620)	1.90 (1.283)	2.4 (1.620)	2.4 (1.620)
Cassette Grille	Model name			UTG-UKYA-W: White wired remote controller (touch panel)						
	Dimensions (H x W x D)		mm	53 x 950 x 950	53 x 950 x 950	53 x 950 x 950	53 x 950 x 950	53 x 950 x 950	53 x 950 x 950	53 x 950 x 950
Cassette Grille	Weight		kg	6.0	6.0	6.0	6.0	6.0	6.0	6.0

\*1: IR Receiver kit and Human sensor kit cannot be connected.

Circular Cassette (Slim type)



Model name	Indoor unit			AUXG18KRL B	AUXG22KRL B	AUXG24KRL B
	Outdoor unit			AOEG18KATA	AOEG22KATA	AOEG24KATA
Power Source	Single phase, ~230 V, 50 Hz					
Capacity	Cooling	Rated	kW	5.2	6.0	6.8
		Min.-Max.		0.9-5.4	0.9-6.3	0.9-7.4
	Heating	Rated		6.0	7.0	7.5
		Min.-Max.		0.9-6.3	0.9-7.4	0.9-8.6
Input Power	Cooling/Heating		kW	1.60/1.66	1.85/1.93	2.12/1.97
EER	Cooling		W/W	3.25	3.24	3.21
COP	Heating		W/W	3.61	3.63	3.81
Pdesign	Cooling/Heating (-10°C)		kW	5.2/3.8	6.0/4.4	6.8/5.4
SEER	Cooling		W/W	6.2	6.2	6.1
SCOP	Heating		W/W	4.1	4.1	4.0
Energy Efficiency Class	Cooling			A++	A++	A++
	Heating			A+	A+	A+
Max. Operating Current	Cooling/Heating		A	10.1/10.1	11.6/11.6	12.6/12.6
Annual Energy Consumption	Cooling		kWh/a	293	338	390
	Heating		kWh/a	1,297	1,502	1,887
Moisture Removal			l/h	1.5	2.2	2.7
	Indoor (Cooling)	H/M/L/Q		33/32/31/28	33/32/31/28	35/33/32/29
Sound Pressure Level	Indoor (Heating)	H/M/L/Q		33/32/31/28	33/32/31/28	35/33/32/29
	Outdoor (Cooling/Heating)	High		51/52	52/53	54/55
Sound Power Level	Indoor (Cooling/Heating)	High		47/47	49/49	49/49
	Outdoor (Cooling/Heating)	High		63/64	64/65	66/67
Airflow Rate	Indoor/Outdoor (Cooling)	High	m³/h	1,050/1,710	1,050/2,240	1,150/2,885
	Indoor/Outdoor (Heating)	High	m³/h	1,050/1,840	1,050/2,240	1,150/2,350
Net Dimensions H x W x D	Indoor	mm		246 x 840 x 840	246 x 840 x 840	246 x 840 x 840
	Outdoor	mm		542 x 799 x 290	632 x 799 x 290	632 x 799 x 290
Weight	Indoor	kg		23	24	24
	Outdoor	kg		33	36	38
Connection Pipe Diameter (Liquid/Gas)	mm			6.35/12.70	6.35/12.70	6.35/12.70
Drain port Diameter (I.D./O.D.)	mm			25/32	25/32	25/32
Max. Pipe Length (Pre-Charge)	m			20 (15)	25 (15)	25 (20)
Max. Height Difference	m			15	20	20
Operating Range	Cooling	°CDB		-10 to 46	-10 to 46	-10 to 46
	Heating		-15 to 24	-15 to 24	-15 to 24	
Refrigerant	Type (Global Warming Potential)			R32 (675)	R32 (675)	R32 (675)
	Charge		kg (CO2eq-T)	0.9 (0.608)	1.1 (0.743)	1.25 (0.844)
Cassette Grille	Model name			UTG-UKYA-W: White wired remote controller (touch panel)		
	Dimensions (H x W x D)		mm	53 x 950 x 950	53 x 950 x 950	53 x 950 x 950
Cassette Grille	Weight		kg	6.0	6.0	6.0

\*1: IR Receiver kit and Human sensor kit cannot be connected.

Slim Duct

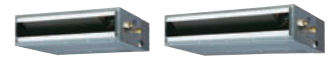

Model name	Indoor unit			ARXG09KLL AP	ARXG12KLL AP	ARXG14KLL AP	ARX
------------	-------------	--	--	--------------	--------------	--------------	-----



Medium Static Pressure Duct (High-Efficiency & Comfort)



Model name	Indoor unit		ARXH12KMTAP	ARXH14KMTAP	ARXH18KMTAP	ARXH22KMTAP	ARXH24KMTAP
	Outdoor unit		AOEG12KATA	AOEG14KATA	AOEG18KATA	AOEG22KATA	AOEG24KATA
Power Source	Single phase, ~230 V, 50 Hz						
Capacity	Cooling	Rated	3.5	4.3	5.2	6.0	6.8
		Min.-Max.	0.9-3.7	0.9-4.5	0.9-5.4	0.9-6.3	0.9-7.4
	Heating	Rated	4.1	5.0	6.0	7.0	7.5
		Min.-Max.	0.9-4.4	0.9-5.3	0.9-6.3	0.9-7.4	0.9-8.6
Input Power	Cooling/Heating		1.060 / 1.170	1.340 / 1.420	1.730 / 1.820	1.85 / 1.97	2.06 / 1.97
EER	Cooling		3.30	3.21	3.00	3.24	3.30
COP	Heating		3.50	3.52	3.30	3.55	3.81
Pdesign	Cooling/Heating (-10°C)		3.5 / 2.8	4.3 / 3.2	5.2 / 3.8	6.0 / 4.4	6.8 / 5.4
SEER	Cooling		6.00	5.80	5.90	6.00	6.00
SCOP	Heating (Average)		3.90	3.90	3.90	3.90	3.90
Energy Efficiency Class	Cooling		A+	A+	A+	A+	A+
	Heating (Average)		A	A	A	A	A
Max. Operating Current	Cooling/Heating		7.7 / 7.7	9.2 / 9.2	10.1 / 10.1	11.6 / 11.6	12.6 / 12.6
Annual Energy Consumption	Cooling		212	267	316	358	405
	Heating		1,005	1,148	1,363	1,578	1,936
Moisture Removal			l/h	1.3	1.3	2.0	2.2
Sound Pressure Level	Indoor (Cooling)	H/M/L/Q	29 / 27 / 25 / 23	32 / 29 / 27 / 25	33 / 30 / 28 / 26	32 / 28 / 25 / 24	34 / 30 / 28 / 26
	Indoor (Heating)	H/M/L/Q	29 / 27 / 25 / 23	32 / 29 / 27 / 25	33 / 30 / 28 / 26	32 / 28 / 25 / 24	34 / 30 / 28 / 26
Sound Power Level	Outdoor (Cooling/Heating)	High	49 / 50	50 / 51	51 / 52	52 / 53	54 / 55
	Indoor (Cooling/Heating)	High	58 / 58	59 / 59	60 / 60	58 / 58	60 / 60
Airflow Rate	Indoor/Outdoor (Cooling)	High	650 / 1,630	800 / 1,670	840 / 1,710	1,150 / 2,240	1,230 / 2,885
	Indoor/Outdoor (Heating)	High	650 / 1,410	800 / 1,580	840 / 1,840	1,150 / 2,240	1,230 / 2,350
Static pressure range (Standard)			Pa	30 to 150 (40)	30 to 150 (40)	30 to 150 (40)	30 to 150 (50)
Net Dimensions H x W x D	Indoor		mm	240 x 700 x 700	240 x 700 x 700	240 x 1,000 x 700	240 x 1,000 x 700
Weight	Indoor		kg	24	24	31	31
	Outdoor		kg	25	32	33	36
Connection Pipe Diameter (Liquid/Gas)			mm	6.35 / 9.52	6.35 / 9.52	6.35 / 12.7	6.35 / 12.70
Drain Hose Diameter (I.D./O.D.)			mm	25 / 32	25 / 32	25 / 32	25 / 32
Max. Pipe Length (Pre-Charge)			m	15 (15)	20 (15)	20 (15)	25 (20)
Max. Height Difference			m	15	15	20	20
Operating Range	Cooling		°CDB	-10 to 46	-10 to 46	-10 to 46	-10 to 46
	Heating		°CDB	-15 to 24	-15 to 24	-15 to 24	-15 to 24
Refrigerant	Type (Global Warming Potential)			R32 (675)	R32 (675)	R32 (675)	R32 (675)
	Charge		kg (CO2eq-T)	0.70 (0.473)	0.85 (0.574)	0.90 (0.608)	1.10 (0.743)

Medium Static Pressure Duct (High-Efficiency & Comfort)



Model name	Indoor unit		ARXH30KMTAP	ARXH36KMTAP	ARXH45KMTAP	ARXH36KMTAP	ARXH45KMTAP
	Outdoor unit		AOEG30KATA	AOEG36KATA	AOEG45KATA	AOEG36KQTA	AOEG45KQTA
Power Source	Single phase, ~230 V, 50 Hz				3-phase, ~400 V, 50 Hz		
Capacity	Cooling	Rated	8.5	9.5	12.1	9.5	12.1
		Min.-Max.	2.8-9.6	2.8-10.6	4.0-12.6	2.8-10.6	4.0-12.6
	Heating	Rated	10.0	10.8	13.5	10.8	13.5
		Min.-Max.	2.7-10.8	2.7-12.5	4.2-15.0	2.7-12.5	4.2-15.0
Input Power	Cooling/Heating		2.69 / 2.63	3.13 / 2.88	4.84 / 4.18	3.13 / 2.88	4.84 / 4.18
EER	Cooling		3.16	3.04	2.50	3.04	2.50
COP	Heating		3.80	3.75	3.23	3.75	3.23
Pdesign	Cooling/Heating (-10°C)		8.5 / 8.0	9.5 / 8.7	-	9.5 / 8.7	-
SEER	Cooling		5.80	5.60	-	5.60	-
SCOP	Heating (Average)		3.90	3.90	-	3.90	-
Energy Efficiency Class	Cooling		A+	A+	-	A+	-
	Heating (Average)		A	A	-	A	-
Max. Operating Current	Cooling/Heating		22.5 / 22.5	22.5 / 22.5	28.1 / 28.1	10.5 / 10.5	13.6 / 13.6
Annual Energy Consumption	Cooling		520	601	-	601	-
	Heating		2,867	3,118	-	3,118	-
Moisture Removal			l/h	1.8	2.0	4.0	4.0
Sound Pressure Level	Indoor (Cooling)	H/M/L/Q	38 / 34 / 31 / 28	38 / 34 / 31 / 28	40 / 36 / 32 / 29	38 / 34 / 31 / 28	40 / 36 / 32 / 29
	Indoor (Heating)	H/M/L/Q	38 / 34 / 31 / 28	38 / 34 / 31 / 28	40 / 36 / 32 / 29	38 / 34 / 31 / 28	40 / 36 / 32 / 29
Sound Power Level	Outdoor (Cooling/Heating)	High	53 / 55	55 / 55	58 / 59	55 / 55	58 / 59
	Indoor (Cooling/Heating)	High	64 / 64	65 / 65	67 / 67	65 / 65	67 / 67
Airflow Rate	Indoor/Outdoor (Cooling)	High	1,950 / 3,750	2,070 / 3,750	2,160 / 4,450	2,070 / 3,750	2,160 / 4,450
	Indoor/Outdoor (Heating)	High	1,950 / 3,750	2,070 / 3,750	2,160 / 4,450	2,070 / 3,750	2,160 / 4,450
Static pressure range (Standard)			Pa	30 to 150 (50)	30 to 150 (50)	30 to 150 (60)	30 to 150 (60)
Net Dimensions H x W x D	Indoor		mm	240 x 1,400 x 700	240 x 1,400 x 700	240 x 1,400 x 700	240 x 1,400 x 700
Weight	Indoor		kg	788 x 940 x 320	788 x 940 x 320	998 x 940 x 320	788 x 940 x 320
	Outdoor		kg	42	42	61	53
Connection Pipe Diameter (Liquid/Gas)			mm	9.52 / 15.88	9.52 / 15.88	9.52 / 15.88	9.52 / 15.88
Drain Hose Diameter (I.D./O.D.)			mm	25 / 32	25 / 32	25 / 32	25 / 32
Max. Pipe Length (Pre-Charge)			m	30 (30)	30 (30)	30 (30)	30 (30)
Max. Height Difference			m	30	30	30	30
Operating Range	Cooling		°CDB	-10 to 46	-10 to 46	-10 to 46	-10 to 46
	Heating		°CDB	-15 to 24	-15 to 24	-15 to 24	-15 to 24
Refrigerant	Type (Global Warming Potential)			R32 (675)	R32 (675)	R32 (675)	R32 (675)
	Charge		kg (CO2eq-T)	1.90 (1.283)	1.90 (1.283)	2.40 (1.620)	1.90 (1.283)

Medium Static Pressure Duct (Standard)





















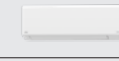





































Model name	Indoor unit		ARXG22KMLB	ARXG24KMLA	ARXG30KMLA	ARXG36KMLA	ARXG45KMLA	ARXG36KMLA	ARXG45KMLA
	Outdoor unit		AOEG22KATA	AOEG24KATA	AOEG30KATA	AOEG36KATA	AOEG45KATA	AOEG36KQTA	AOEG45KQTA
Power Source	Single phase, ~230 V, 50 Hz							3-phase, ~400 V, 50 Hz	
Capacity	Cooling	Rated	6.0	6.8	8.5	9.5	12.1	9.5	12.1
		Min.-Max.	0.9-6.3	0.9-7.4	2.8-9.6	2.8-10.6	4.0-12.6	2.8-10.6	4.0-12.6
	Heating	Rated	7.0	7.5	10.0	10.8	13.5	10.8	13.5
		Min.-Max.	0.9-7.4	0.9-8.6	2.7-10.8	2.7-12.5	4.2-15.0	2.7-12.5	4.2-15.0
Input Power	Cooling/Heating		1.92/2.00	2.19/2.00	2.78/2.77	3.13/3.03	4.84/4.18	3.13/3.03	4.84/4.18
EER	Cooling		3.13	3.11	3.06	3.04	2.50	3.04	2.50
COP	Heating		3.50	3.75	3.61	3.56	3.23	3.56	3.23
Pdesign	Cooling/Heating (-10°C)		6.0/4.4	6.8/5.4	8.5/8.0	9.5/8.7	-	9.5/8.7	-
SEER	Cooling		5.8	5.9	5.8	5.6	-	5.6	-
SCOP	Heating (Average)		3.8	3.9	3.9	3.9	-	3.9	-
Energy Efficiency Class	Cooling		A+	A+	A+	A+	-	A+	-
	Heating		A	A	A	A	-	A	-
Max. Operating Current	Cooling/Heating		11.6/11.6	12.6/12.6	22.5/22.5	22.5/22.5	28.1/28.1	10.5/10.5	13.6/13.6
Annual Energy Consumption	Cooling		362	403	513	594	-	594	-
	Heating		1,620	1,935	2,871	3,122	-	3,122	-
Moisture Removal			l/h	2.1	2.5	2.5	4.0	3.0	4.0
Sound Pressure Level	Indoor (Cooling)	H/M/L/Q	31/29/27/25	31/29/27/25	39/35/30/26	39/35/30/26	42/38/32/28	39/35/30/26	42/38/32/28
	Indoor (Heating)	H/M/L/Q	31/29/27/25	31/29/27/25	42/35/30/26	42/35/30/26	42/38/32/28	42/35/30/26	42/38/32/28
Sound Power Level	Outdoor (Cooling/Heating)	High	52/53	54/55	53/55	55/55	58/59	55/55	58/59
	Indoor (Cooling/Heating)	High	60/62	60/62	65/69	65/70	68/70	65/70	68/70
Airflow Rate	Indoor/Outdoor (Cooling)	High	1,100/2,240	1,100/2,885	1,900/3,750	1,900/3,750	2,100/4,450	1,900/3,750	2,100/4,450
	Indoor/Outdoor (Heating)	High	1,100/2,240	1,100/2,350	2,100/3,750	2,100/3,750	2,100/4,450	2,100/3,750	2,100/4,450
Static pressure range (Standard)			Pa	30 - 150 (35)	30 - 150 (35)	30 - 150 (47)	30 - 150 (47)	30 - 150 (60)	30 - 150 (60)
Net Dimensions H x W x D	Indoor		mm	270 x 1,135 x 700	270 x 1,135 x 700	270 x 1,135 x 700	270 x 1,135 x 700	270 x 1,135 x 700	270 x 1,135 x 700
Weight	Indoor		kg	35	35	38	38	39	39
	Outdoor		kg	36	38	52	52	61	62
Connection Pipe Diameter (Liquid/Gas)			mm	6.35/12.70	6.35/12.70	9.52/15.88	9.52/15.88	9.52/15.88	9.52/15.88
Drain port Diameter (I.D./O.D.)			mm	25/32	25/32	25/32	25/32	25/32	
Max. Pipe Length (Pre-Charge)			m	25 (15)	25 (20)	30 (30)	30 (30)	30 (30)	
Max. Height Difference			m	20	20	30	30	30	
Operating Range	Cooling		°CDB	-10 to 46	-10 to 46	-10 to 46	-10 to 46	-10 to 46	
	Heating		°CDB	-15 to 24	-15 to 24	-15 to 24	-15 to 24	-15 to 24	
Refrigerant	Type (Global Warming Potential)			R32 (675)	R32 (675)	R32 (675)	R32 (675)	R32 (675)	
	Charge		kg (CO2eq-T)	1.1 (0.743)	1.25 (0.844)	1.90 (1.283)	1.90 (1.283)	2.4 (1.620)	1.9 (1.283)

Ceiling



Model name	Indoor unit		ABEG18KRTA	ABEG22KRTA	ABEG24KRTA	ABEG30KRTA	ABEG36KRTA	ABEG45KRTA	ABEG36KRTA	ABEG45KRTA
	Outdoor unit		AOEG18KATA	AOEG22KATA	AOEG24KATA	AOEG30KATA	AOEG36KATA	AOEG45KATA	AOEG36KQTA	AOEG45KQTA
Power Source	Single phase, ~230 V, 50 Hz							3-phase, ~400 V, 50 Hz		
Capacity	Cooling	Rated	5.2	6.0	6.8	8.5	9.5	12.1	9.5	12.1
		Min.-Max.	0.9-5.4	0.9-6.3	0.9-7.4	2.8-9.6	2.8-10.6	4.0-12.6	2.8-10.6	4.0-12.6
	Heating	Rated	6.0	7.0	7.5	10.0	10.8	13.5	10.8	13.5
		Min.-Max.	0.9-6.3	0.9-7.4	0.9-8.6	2.7-10.8	2.7-12.5	4.2-15.0	2.7-12.5	4.2-15.0
Input Power	Cooling/Heating		1.66/1.71	1.95/2.09	2.19/2.00	2.78/2.86	3.13/3.03	4.84/4.18	3.13/3.03	4.84/4.18
EER	Cooling		3.13	3.08	3.11	3.06	3.04	2.50	3.04	2.50
COP	Heating		3.51	3.35	3.75	3.5	3.56	3.23	3.56	3.23
Pdesign	Cooling/Heating (-10°C)		5.2/3.8	6.0/4.4	6.8/5.4	8.5/8.0	9.5/8.7	-	9.5/8.7	-
SEER	Cooling		5.8	5.6	6.0	5.8	5.6			

# Feature Summary

Type	Wall-mounted type				Wall-mounted type				
Series	Designer Range		Standard Range		Standard Range		ECO Range		
Model name									
	ASEH07/09/12/14KGTG, ASYG07/09/12/14KGTG, ASYG07/09/12/14KGTGTE	ASEG07/09/12/14KETF ASEG07/09/12/14KETF-B, ASYG07/09/12/14KETE ASYG07/09/12/14KETE-B	ASEH07/09/12/14KMCG, ASYG07/09/12/14KMCF, ASYG07/09/12/14KMCE	ASEG18/24KMTE	ASEH30/36KMTB	ASEH07/09/12KNCA	ASEG07/09/12KPCE	ASEG18/24KLCA	ASEH07/09/12KLTA
									
Energy-Saving Features	 Save Human sensor	●				●			
	 Human sensor control								
	 Economy operation	●	●	●	●	●	●	●	●
	 Setting temperature range limitation	○	○	○	○	○			
	 Set temperature auto return	○	○	○	○	○			
Features for Comfort	 Power diffuser								
	 Powerful operation	●	●	●	●	●	●	●	●
	 10°C Heat	●	●	●	●	●	●		
	 Outdoor unit low noise operation	●	●	●	●	●			
	 Auto changeover	●	●	●	●	●	●	●	●
	 UP/DOWN swing louver	●	●	●			●	●	●
	 Double swing automatic				●	●			
	 Automatic fan speed	●	●	●	●	●	●	●	●
	 Auto restart	●	●	●	●	●	●	●	●
	 Connectable fresh air duct								
	 Fresh air intake								
	 Connectable distributing duct								
	 Individual airflow direction control								
	Convenience Features	 Auto-off timer	○	○	○	○	○		
 Sleep timer		●	●	●	●	●	●	●	●
 Program timer		●	●	●	●	●	●	●	●
 Weekly timer		●	●	○	●	●	● <sup>*3</sup>		
 Weekly & Temperature setback timer		○	○	○	○	○			
 Filter sign		●	●	●	●	●	●	●	●
 External error output		○	○	○	○	○			
 External ON/OFF input		○	○	○	○	○			
 Wireless LAN control		● (KGTG, KGTG) ○ (KGTGTE)	● (KETF, KETF-B) ○ (KETE, KETE-B)	● (KMCF, KMCG) ○ (KMCE)	○	○	●	○	○
 Multi system control						○			
 Special cooling					● <sup>*2</sup>				
Clean Features	 Ion deodorization filter	●	●	●	●	●			
	 Apple-catechin filter	●	●	●	●	●			
	 Long-life filter								
	 Washable panel	●	●	●	●	●	●	●	●
	 Silver Ion Filter	○	○	○	○	○	○	○	○
Installation Support	 Automatic airflow adjustment								
	 Drain pump as standard								
	 Blue fin					●	●		●
	 Refrigerant cycle monitor	○ (KGTG)		○ (KMCG)		○	○		○

\*1 For details of Multi System Control function, refer to C-013.

\*2 Wired remote controller (UTY-RNRYZ5) is required to use Special Cooling function.

\*3: It is only available on the AIRSTAGE Mobile application and wired remote controller. It can not be used via wireless remote controller.

○: Optional function



# Feature Summary

Type	Cassette		Duct			Duct					Floor	Ceiling
Series	Compact 4-way Flow Series	Circular Flow Series	Slim (With drain pump)	Medium Static Pressure (High-Efficiency & Comfort)	Medium Static Pressure (Compact size)	Medium Static Pressure (Standard)	High Static Pressure		Big			
Model name	AUXG 09/12/14/18/22/24 KVLA	AUXG 18/22/24/30/36/45/54 KRLB	ARXG 09/12/14/18 KLLAP	ARXH 12/14/18/22/24/30/36/45/54 KMTAP	ARXG 12/14/18/22/24/30/36/45/54 KHTAP	ARXG22KMLB ARXG24/30/36/45KMLA	ARXG45/54KHTB	ARYG60LHTA	ARYG72/90LHTA	AGEG09/12/14KVCA	ABEG 18/22/24/30/36/45/54 KRTA	
Energy-Saving Features	Save Human sensor											
	Human sensor control		○									
	Economy operation	●	●	●	○	●	●	●	●	●	●	
	Setting temperature range limitation	○	●	○	○	●	○	○	○	●	●	
	Set temperature auto return	●	●	●	○	●	●	○	○	●	●	
Features for Comfort	Power diffuser											
	Powerful operation									●		
	10°C Heat	●	○	○	○	○	○	○	○	●	○	
	Outdoor unit low noise operation		○ (45/54)			○ (45/54)	○ (45) (36/LMLA)	○	○	●	○	
	Auto changeover	●	●	●	●	●	●	●	●	●	●	
	UP/DOWN swing louver	●	●	○						●	●	
	Double swing automatic											
	Automatic fan speed	●	●	●	●	●	●	●	●	●	●	
	Auto restart	●	●	●	●	●	●	●	●	●	●	
	Connectable fresh air duct		●		●	●	●				●	
	Fresh air intake	○	○	○	○	○	○	○	○		○	
	Connectable distributing duct		●				●					
	Individual airflow direction control		●									
Convenience Features	Auto-off timer	●	●	●	●	●	●	○	●	○	●	
	Sleep timer	●	○	○	○	○	○	○	○	●	○	
	Program timer	●	○	○	●	○	○	○	○	●	○	
	Weekly timer	●	●	●	○	●	●	●	●	●	●	
	Weekly & Temperature setback timer	○		●			●	●	●			
	Filter sign	●	●	●	●	●	●	●	●	●	●	
	External error output		○		●	○		○	○	○	○	
	External ON/OFF input	●	●	●	●	●	●	●	○	●	●	
	Wireless LAN control	○	○	○	○	○	○	○	○	○	○	
	Multi system control											
Special cooling												
Clean Features	Ion deodorization filter									●		
	Apple-catechin filter									●		
	Long-life filter				○	○	○	○	○			
	Washable panel											
Installation Support	Silver Ion Filter	○	○	○	○	○	○	○	○	○		
	Automatic airflow adjustment				●	●			●			
	Drain pump as standard	●	●	●	●	●	○		○		○	
	Blue fin		● (30/36/45/54)		● (30/36/45/54)	● (30/36/45/54)	● (30/36/45)	●	●	●	● (30/36/45/54)	
	Refrigerant cycle monitor				○							

\*1 For details of Multi System Control function, refer to C-013.

\*2 Wired remote controller (UTY-RNRYZ5) is required to use Special Cooling function.

\*3: It is only available on the AIRSTAGE Mobile application and wired remote controller. It can not be used via wireless remote controller.

○: Optional function